

Inhaltsverzeichnis

EPLAN_F06_002

Anlage	Einbauort	Seite	Seitenbeschreibung	Seitenzusatzfeld	Datum	Bearbeiter
PCD2 Module	PCD2.R6000	1	multi-line		2012-10-23	OLM
	PCD2.T814	1	multi-line		2012-08-28	OLM
	PCD2.T851	1	multi-line		2012-08-28	OLM
	PCD2.W200	1	multi-line		2012-08-28	OLM
	PCD2.W200	10	overview		2012-08-28	OLM
	PCD2.W220	1	multi-line		2012-08-28	OLM
	PCD2.W220	10	overview		2012-08-28	OLM
	PCD2.W220Z02	1	multi-line		2012-08-28	OLM
	PCD2.W220Z02	10	overview		2012-08-28	OLM
	PCD2.W220Z12	1	multi-line		2012-08-28	OLM
	PCD2.W220Z12	10	overview		2012-08-28	OLM
	PCD2.W210	1	multi-line		2012-08-28	OLM
	PCD2.W210	10	overview		2012-08-28	OLM
	PCD2.W300	1	multi-line		2012-08-28	OLM
	PCD2.W300	10	overview		2012-08-28	OLM
	PCD2.W310	1	multi-line		2012-08-28	OLM
	PCD2.W310	10	overview		2012-08-28	OLM
	PCD2.W340	1	multi-line		2012-08-28	OLM
	PCD2.W340	10	overview		2012-08-28	OLM
	PCD2.W350	1	multi-line		2012-08-28	OLM
	PCD2.W350	10	overview		2012-08-28	OLM
	PCD2.W360	1	multi-line		2012-08-28	OLM
	PCD2.W360	10	overview		2012-08-28	OLM
	PCD2.W305	1	multi-line		2012-08-28	OLM
	PCD2.W305	10	overview		2012-08-28	OLM
	PCD2.W315	1	multi-line		2012-08-28	OLM
	PCD2.W315	10	overview		2012-08-28	OLM
PCD2.W325	1	multi-line		2012-08-28	OLM	

Inhaltsverzeichnis

EPLAN_F06_002

Anlage	Einbauort	Seite	Seitenbeschreibung	Seitenzusatzfeld	Datum	Bearbeiter
PCD3 Module	PCD3.W220	10	overview		2012-08-28	OLM
	PCD3.W220Z03	1	multi-line		2012-08-28	OLM
	PCD3.W220Z03	10	overview		2012-08-28	OLM
	PCD3.W220Z12	1	multi-line		2012-08-28	OLM
	PCD3.W220Z12	10	overview		2012-08-28	OLM
	PCD3.W210	1	multi-line		2012-08-28	OLM
	PCD3.W210	10	overview		2012-08-28	OLM
	PCD3.W300	1	multi-line		2012-08-28	OLM
	PCD3.W300	10	overview		2012-08-28	OLM
	PCD3.W310	1	multi-line		2012-08-28	OLM
	PCD3.W310	10	overview		2012-08-28	OLM
	PCD3.W340	1	multi-line		2012-08-28	OLM
	PCD3.W340	10	overview		2012-08-28	OLM
	PCD3.W350	1	multi-line		2012-08-28	OLM
	PCD3.W350	10	overview		2012-08-28	OLM
	PCD3.W360	1	multi-line		2012-08-28	OLM
	PCD3.W360	10	overview		2012-08-28	OLM
	PCD3.W305	1	multi-line		2012-08-28	OLM
	PCD3.W305	10	overview		2012-08-28	OLM
	PCD3.W315	1	multi-line		2012-08-28	OLM
	PCD3.W315	10	overview		2012-08-28	OLM
	PCD3.W325	1	multi-line		2012-08-28	OLM
	PCD3.W325	10	overview		2012-08-28	OLM
	PCD3.W400	1	multi-line		2012-08-28	OLM
	PCD3.W400	10	overview		2012-08-28	OLM
	PCD3.W410	1	multi-line		2012-08-28	OLM
	PCD3.W410	10	overview		2012-08-28	OLM
PCD3.W600	1	multi-line		2012-08-28	OLM	

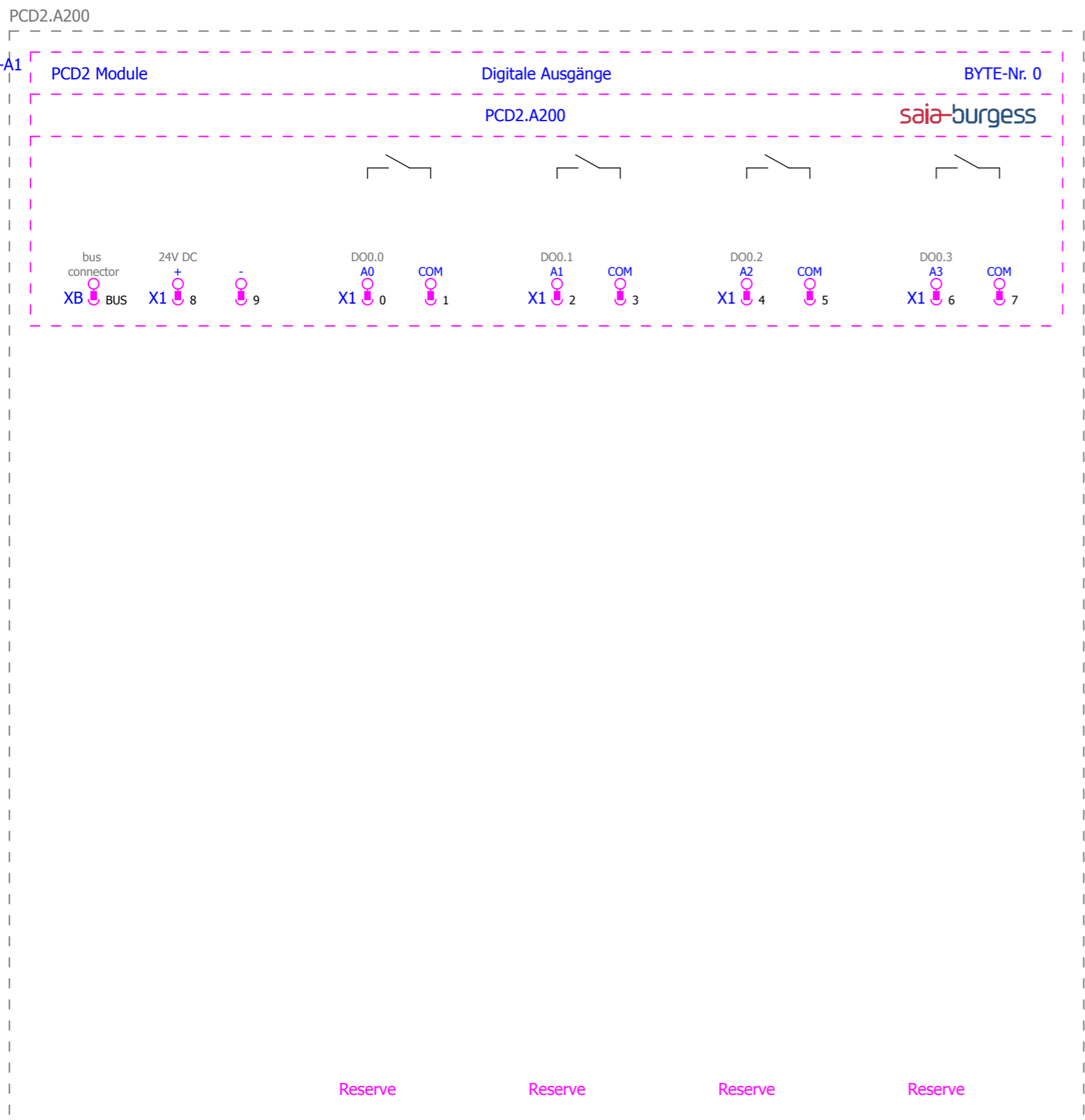

Saia-Burgess\PCD2 Module\PCD2.A200.ema
 Multi-line
 Variant A
 2012-10-26 / 2.1.4

=DOC+/20

			Datum	26.10.2012	EPLAN Software & Service Saia-Burgess Makroprojekt	Saia-Burgess Controls Ltd. <small>Control Systems and Components</small>	Allpolig	= PCD2 Module		Blatt 1	
			Bearb.	KAF				+ PCD2.A200			Blatt 522
			Gepr								
Änderung	Datum	Name	Urspr	Ersatz von	Ersetzt durch						

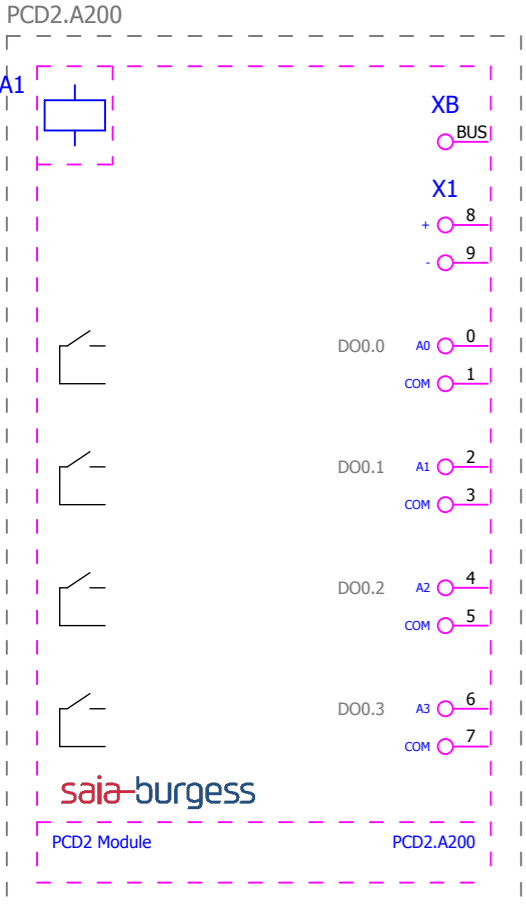

bus connector
 24V DC
 Reserve
 Reserve
 Reserve
 Reserve

Saia-Burgess\PCD2 Module\PCD2.A200.ema
 Overview
 Variant A
 2012-10-26 / 2.1.4

			Datum	26.10.2012	EPLAN Software & Service Saia-Burgess Makroprojekt	Saia-Burgess Controls Ltd. Control Systems and Components	Saia-Burgess Controls Ltd.	SPS-Übersicht	= PCD2 Module		Blatt 10
		Bearb.	KAF	+ PCD2.A200							
		Gepr									
Änderung	Datum	Name	Urspr		Ersatz von	Ersetzt durch				Blatt	522

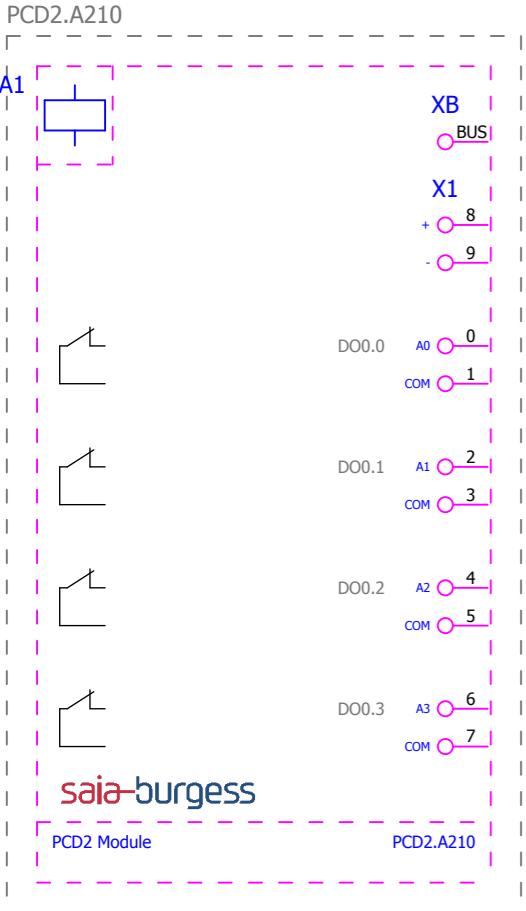

bus connector
 24V DC
 Reserve
 Reserve
 Reserve
 Reserve

Saia-Burgess\PCD2 Module\PCD2.A210.ema
 Overview
 Variant A
 2012-10-26 / 2.1.4

			Datum	26.10.2012	EPLAN Software & Service Saia-Burgess Makroprojekt	Saia-Burgess Controls Ltd. Control Systems and Components	Saia-Burgess Controls Ltd.	SPS-Übersicht	= PCD2 Module		Blatt 10
		Bearb.	KAF	+ PCD2.A210							
		Gepr									
Änderung	Datum	Name	Urspr	Ersatz von	Ersetzt durch					Blatt	522



- bus connector
- 24V DC
- Reserve
- Reserve
- Reserve
- Reserve
- Reserve
- Reserve

Saia-Burgess\PCD2 Module\PCD2.A220.ema
 Overview
 Variant A
 2012-10-26 / 2.1.4

			Datum	26.10.2012	EPLAN Software & Service Saia-Burgess Makroprojekt	Saia-Burgess Controls Ltd. Control Systems and Components	Saia-Burgess Controls Ltd.	SPS-Übersicht	= PCD2 Module		Blatt 10
			Bearb.	KAF					+ PCD2.A220		
			Gepr								
Änderung	Datum	Name	Urspr		Ersatz von	Ersetzt durch				Blatt	522

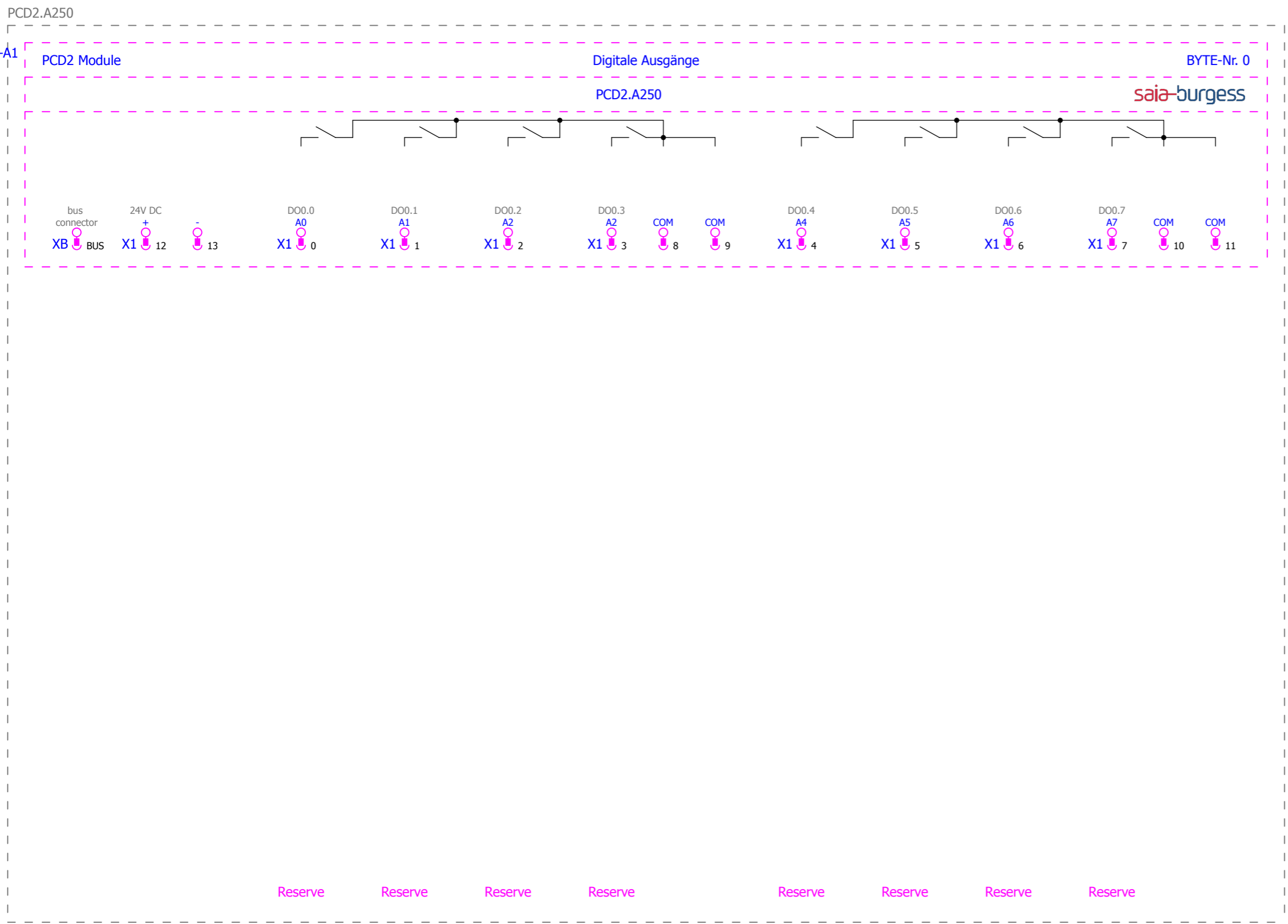

Saia-Burgess\PCD2 Module\PCD2.A250.ema
 Multi-line
 Variant A
 2012-10-26 / 2.1.4

+A220/10

			Datum	26.10.2012	EPLAN Software & Service Saia-Burgess Makroprojekt	Saia-Burgess Controls Ltd. Control Systems and Components	Saia-Burgess Controls Ltd.	Allpolig	= PCD2 Module	
		Bearb.	KAF	+ PCD2.A250						
		Gepr		Blatt					1	
Änderung	Datum	Name	Urspr	Ersatz von	Ersetzt durch				Blatt	522

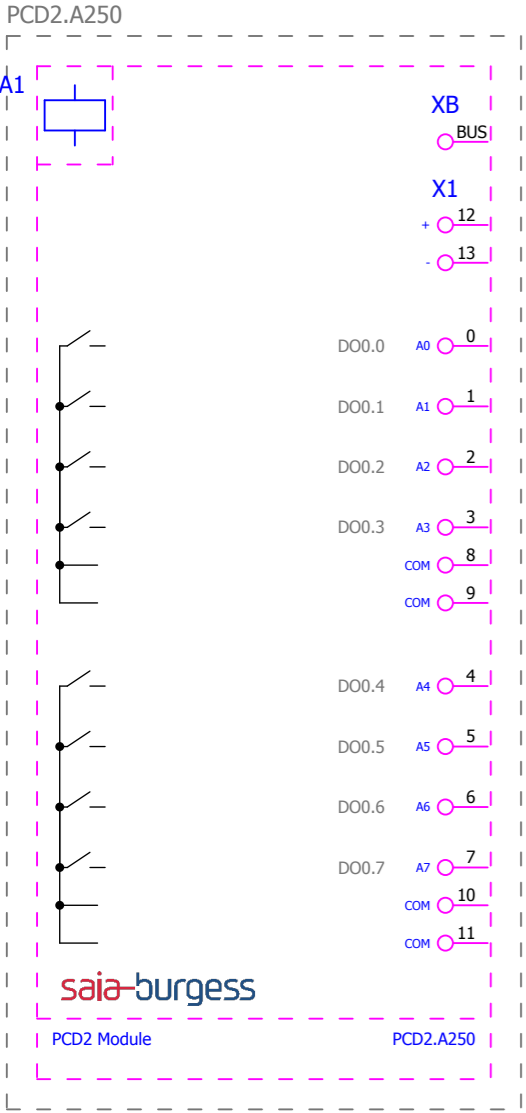

- XB bus connector
- X1 24V DC
- DO0.0 A0 0 Reserve
- DO0.1 A1 1 Reserve
- DO0.2 A2 2 Reserve
- DO0.3 A3 3 Reserve
- COM 8
- COM 9
- DO0.4 A4 4 Reserve
- DO0.5 A5 5 Reserve
- DO0.6 A6 6 Reserve
- DO0.7 A7 7 Reserve
- COM 10
- COM 11

Saia-Burgess\PCD2 Module\PCD2.A250.ema
 Overview
 Variant A
 2012-10-26 / 2.1.4

			Datum	26.10.2012	EPLAN Software & Service Saia-Burgess Makroprojekt	Saia-Burgess Controls Ltd. Control Systems and Components	Saia-Burgess Controls Ltd.	SPS-Übersicht	= PCD2 Module		Blatt 10
		Bearb.	KAF	+ PCD2.A250							
		Gepr									
Änderung	Datum	Name	Urspr	Ersatz von	Ersetzt durch					Blatt	522

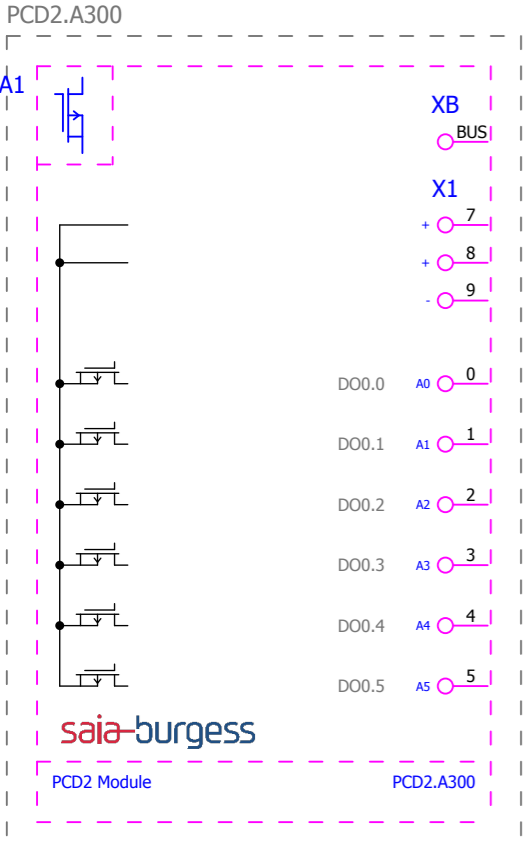

Saia-Burgess\PCD2 Module\PCD2.A300.ema
 Overview
 Variant A
 2012-10-26 / 2.1.4

- bus connector
- 24V DC
- 24V DC
- Reserve
- Reserve
- Reserve
- Reserve
- Reserve
- Reserve

			Datum	26.10.2012	EPLAN Software & Service Saia-Burgess Makroprojekt	Saia-Burgess Controls Ltd. Control Systems and Components	Saia-Burgess Controls Ltd.	SPS-Übersicht	= PCD2 Module		Blatt 10
		Bearb.	KAF	+ PCD2.A300							
		Gepr									
Änderung	Datum	Name	Urspr		Ersatz von	Ersetzt durch				Blatt	522

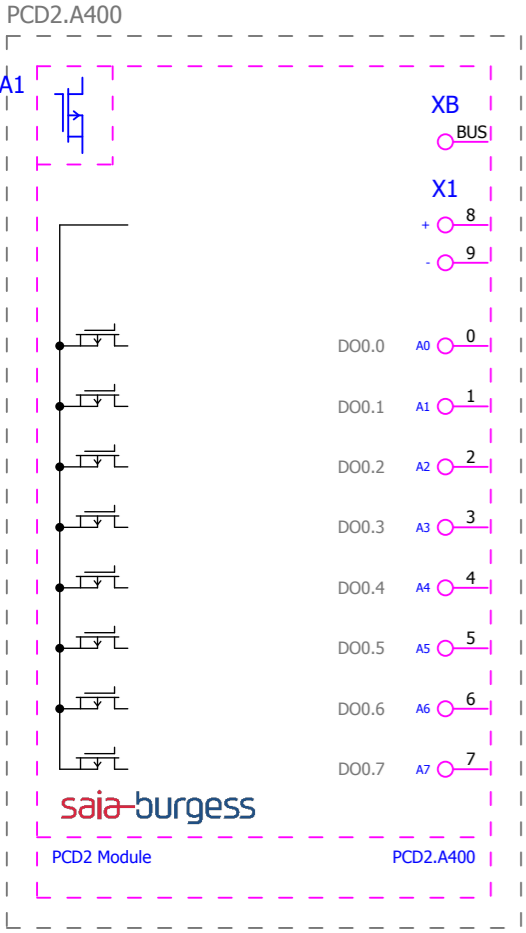

Saia-Burgess\PCD2 Module\PCD2.A400.ema
 Overview
 Variant A
 2012-10-26 / 2.1.4

- bus connector
- 24V DC
- Reserve
- Reserve
- Reserve
- Reserve
- Reserve
- Reserve
- Reserve
- Reserve

			Datum	26.10.2012	EPLAN Software & Service Saia-Burgess Makroprojekt	Saia-Burgess Controls Ltd.	SPS-Übersicht	= PCD2 Module	
			Bearb.	KAF				+ PCD2.A400	
			Gepr					Blatt	10
Änderung	Datum	Name	Urspr		Ersatz von	Ersetzt durch		Blatt	522

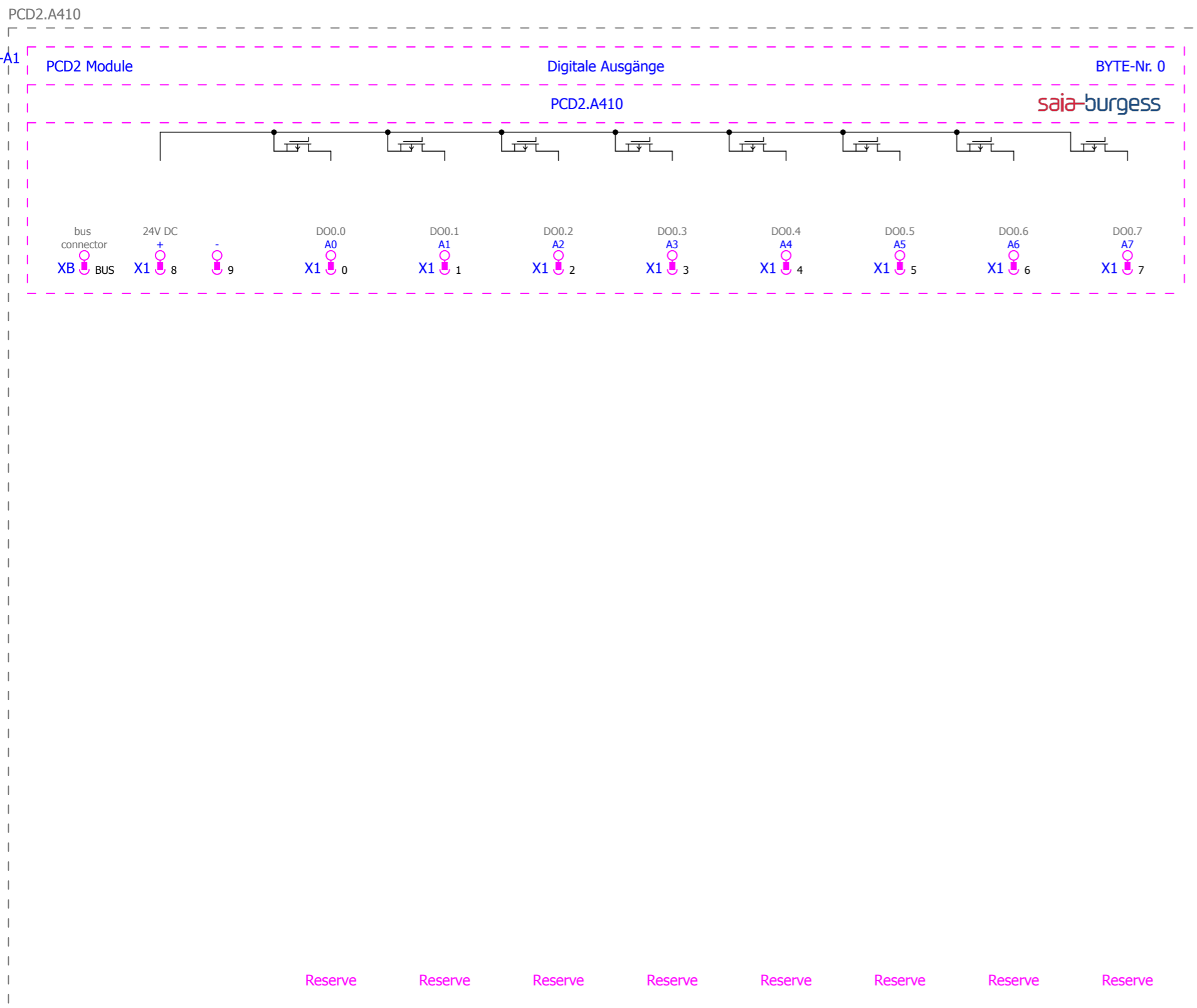

Saia-Burgess\PCD2 Module\PCD2.A410.ema
 Multi-line
 Variant A
 2012-10-26 / 2.1.4

+.A400/10

			Datum	26.10.2012	EPLAN Software & Service Saia-Burgess Makroprojekt	Saia-Burgess Controls Ltd. <small>Control Systems and Components</small>	Allpolig	= PCD2 Module		Blatt 1
		Bearb.	KAF	+ PCD2.A410						
		Gepr								
Änderung	Datum	Name	Urspr	Ersatz von	Ersetzt durch				Blatt	522

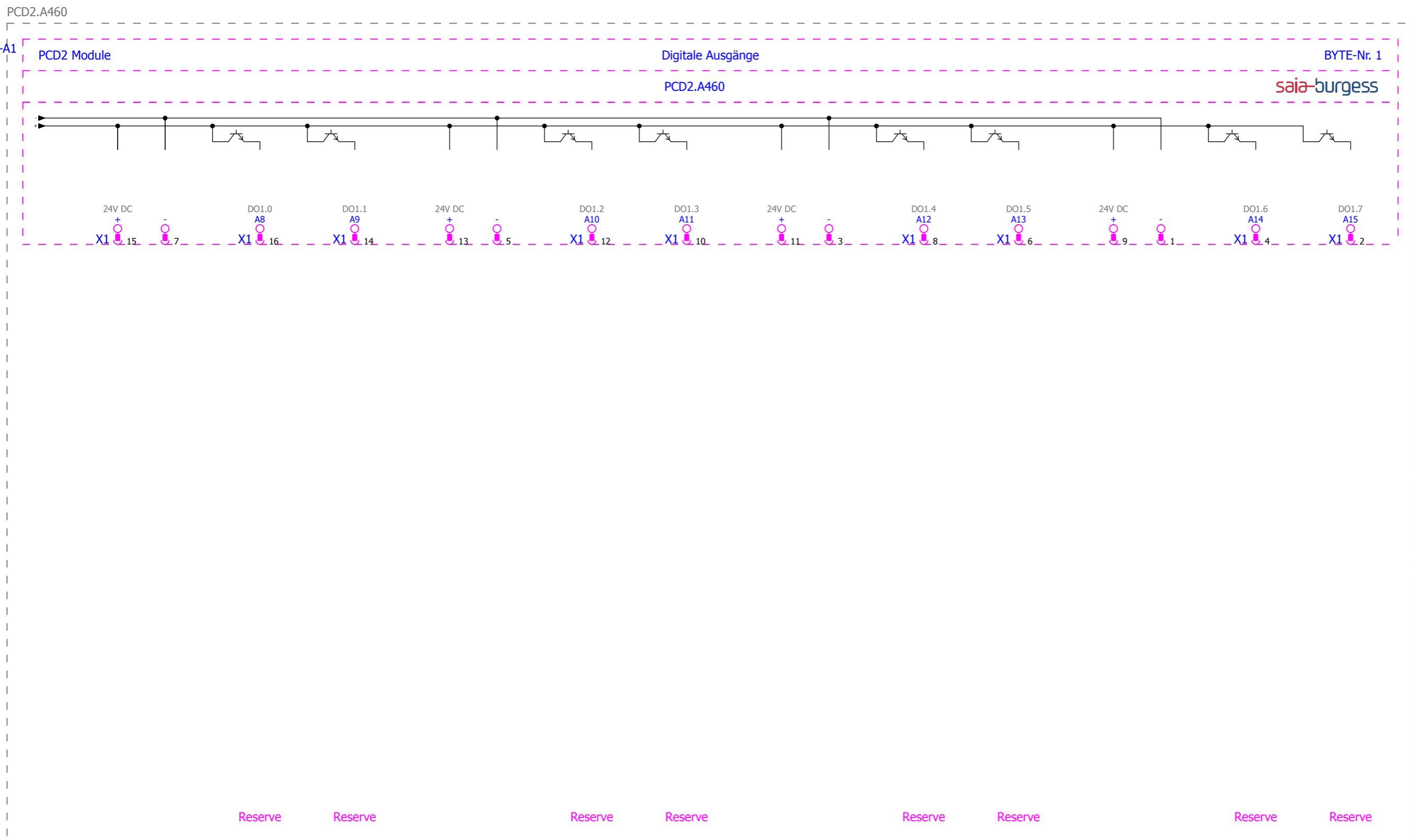

Saia-Burgess\PCD2 Module\PCD2.A460.ema
 Multi-line
 Variant B
 2012-10-26 / 2.1.4

			Datum	26.10.2012	EPLAN Software & Service Saia-Burgess Makroprojekt	Saia-Burgess Controls Ltd. <small>Control Systems and Components</small>	Allpolig	= PCD2 Module	
			Bearb.	KAF				+ PCD2.A460	
			Gepr					Blatt	2
Änderung	Datum	Name	Urspr	Ersatz von	Ersetzt durch				
							Blatt	522	

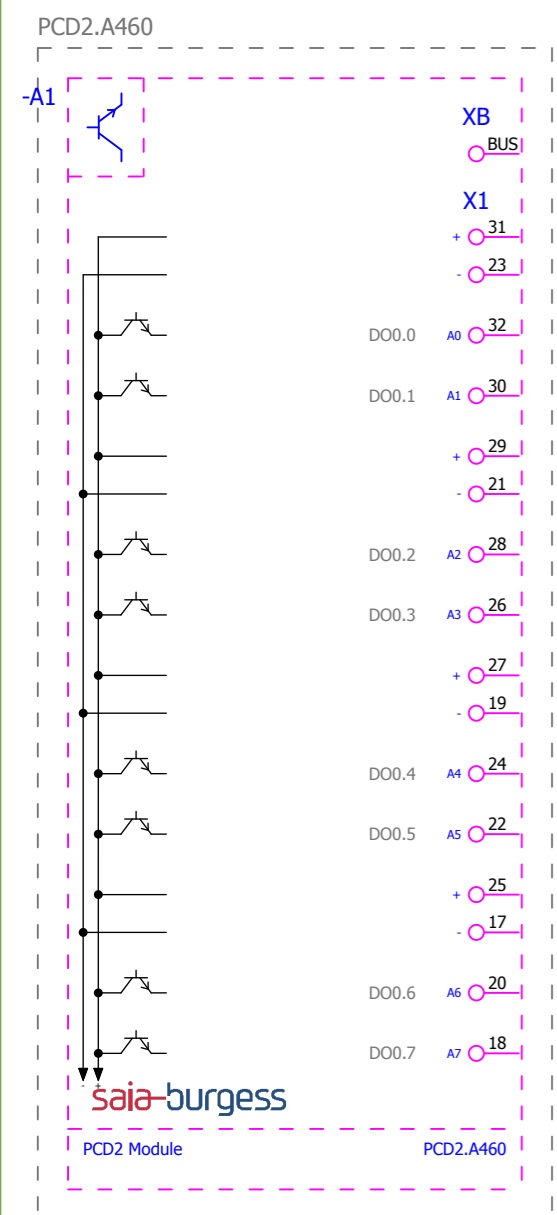

Saia-Burgess\PCD2 Module\PCD2.A460.ema
 Overview
 Variant A
 2012-10-26 / 2.1.4

- bus connector
- 24V DC
- Reserve
- Reserve
- 24V DC
- Reserve
- Reserve
- 24V DC
- Reserve
- Reserve
- 24V DC
- Reserve
- Reserve
- 24V DC
- Reserve
- Reserve

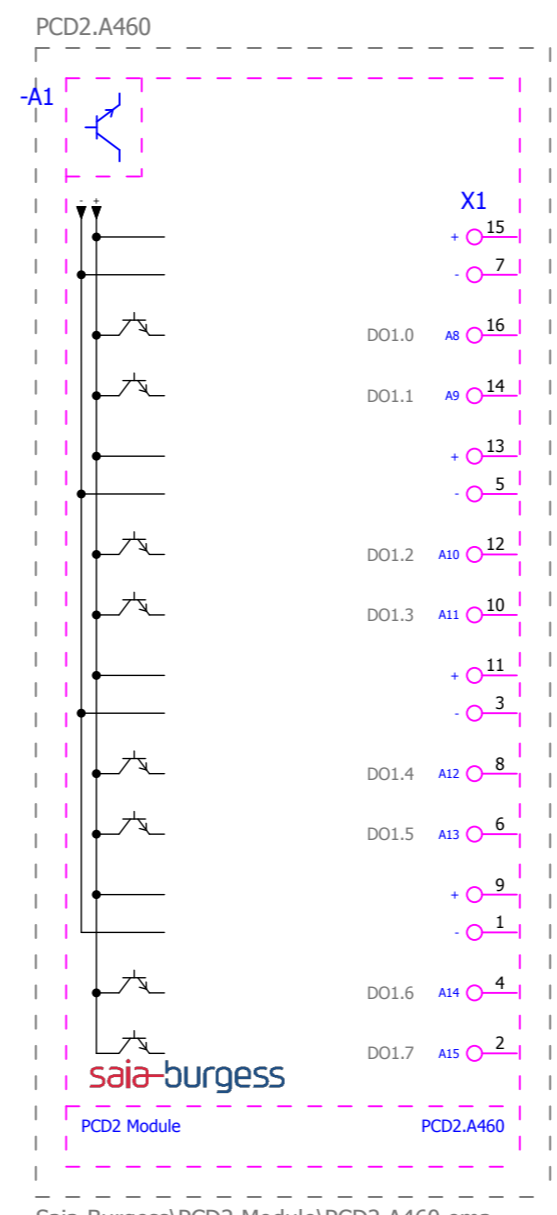

Saia-Burgess\PCD2 Module\PCD2.A460.ema
 Overview
 Variant B
 2012-10-26 / 2.1.4

- 24V DC
- Reserve
- Reserve
- 24V DC
- Reserve
- Reserve
- 24V DC
- Reserve
- Reserve
- 24V DC
- Reserve
- Reserve
- 24V DC
- Reserve
- Reserve

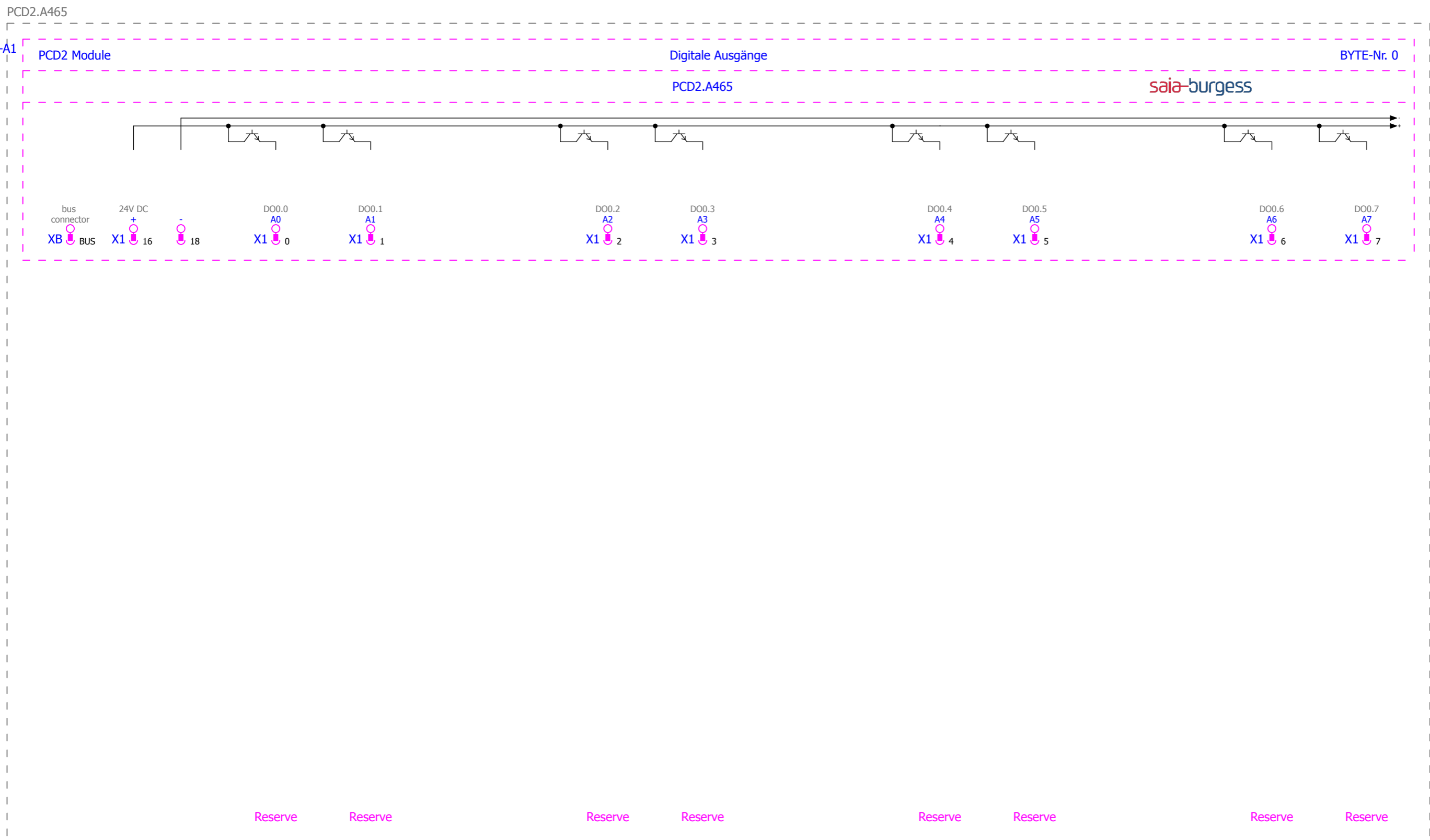

Saia-Burgess\PCD2 Module\PCD2.A465.ema
 Multi-line
 Variant A
 2012-10-26 / 2.1.4

+.A460/10

			Datum	26.10.2012	EPLAN Software & Service Saia-Burgess Makroprojekt	Saia-Burgess Controls Ltd. Control Systems and Components	Saia-Burgess Controls Ltd.	Allpolig	= PCD2 Module	
		Bearb.	KAF	+ PCD2.A465						
		Gepr		Blatt					1	
Änderung	Datum	Name	Urspr	Ersatz von	Ersetzt durch				Blatt	522

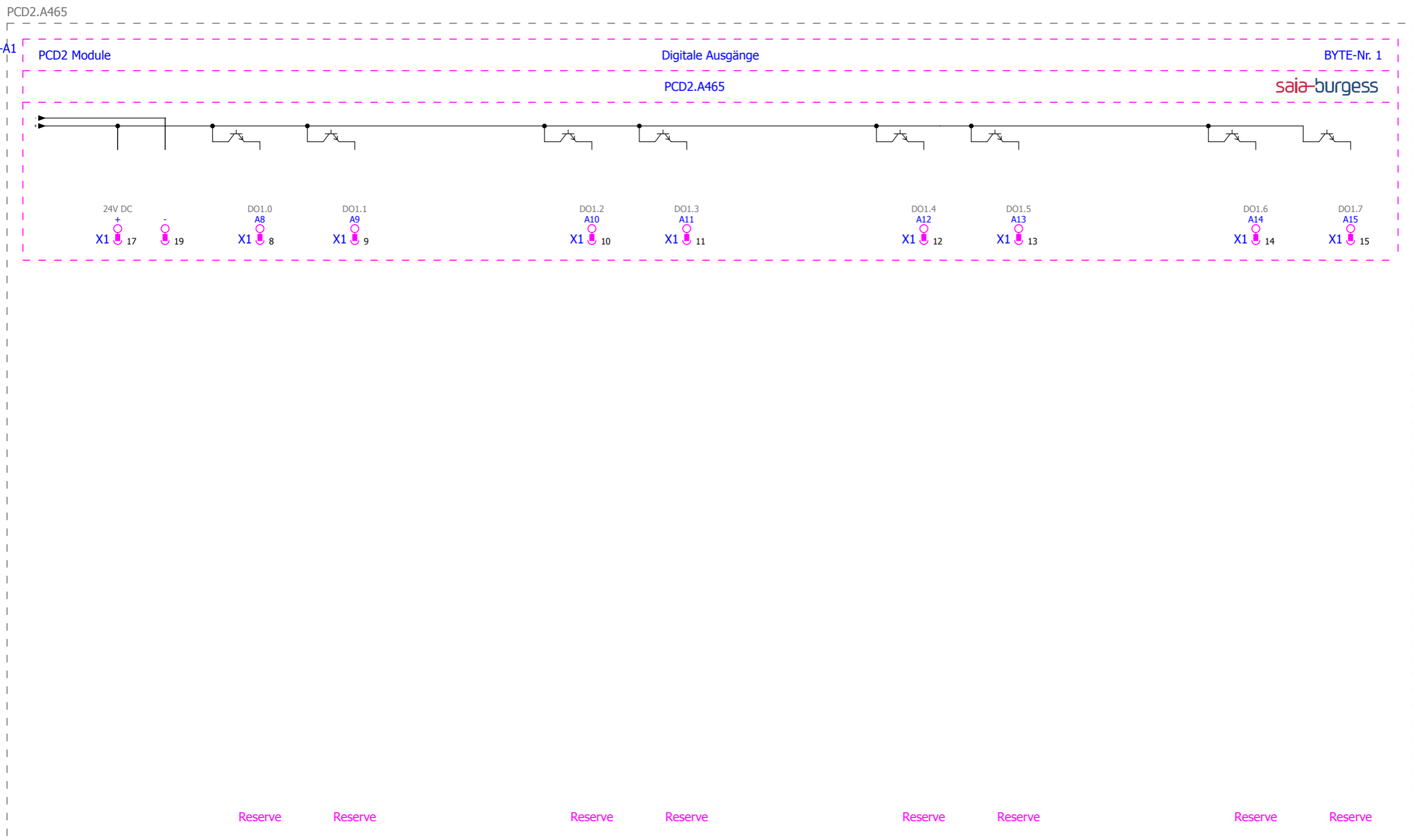

Saia-Burgess\PCD2 Module\PCD2.A465.ema
Multi-line
Variant B
2012-10-26 / 2.1.4

			Datum	26.10.2012	EPLAN Software & Service Saia-Burgess Makroprojekt	Saia-Burgess Controls Ltd. Control Systems and Components	Saia-Burgess Controls Ltd.	Allpolig	= PCD2 Module			
			Bearb.	KAF					+ PCD2.A465		Blatt	2
			Gepr								Blatt	522
Änderung	Datum	Name	Urspr		Ersatz von	Ersetzt durch						

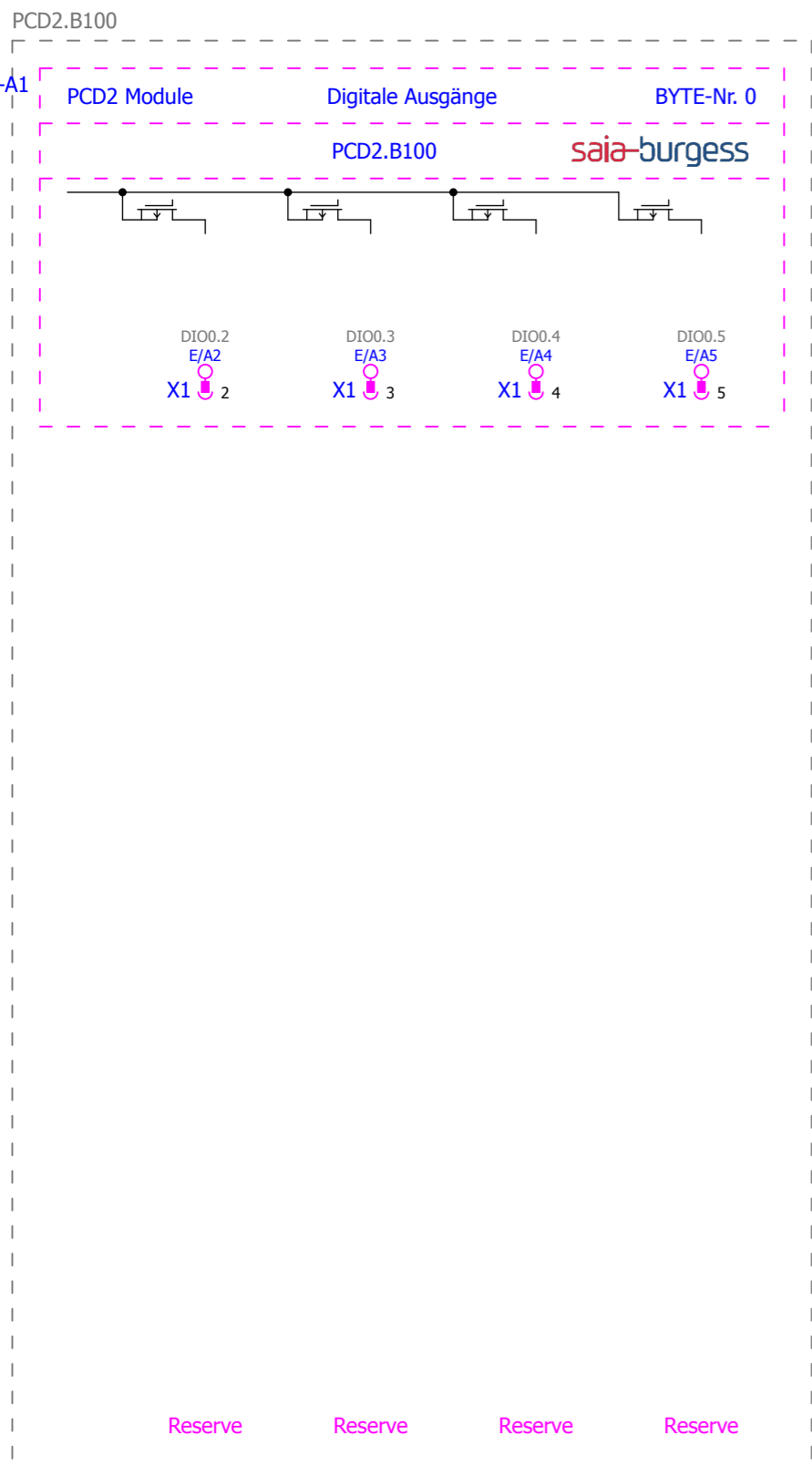

Saia-Burgess\PCD2 Module\PCD2.B100.ema
 Multi-line
 Variant B
 2012-10-26 / 2.1.4

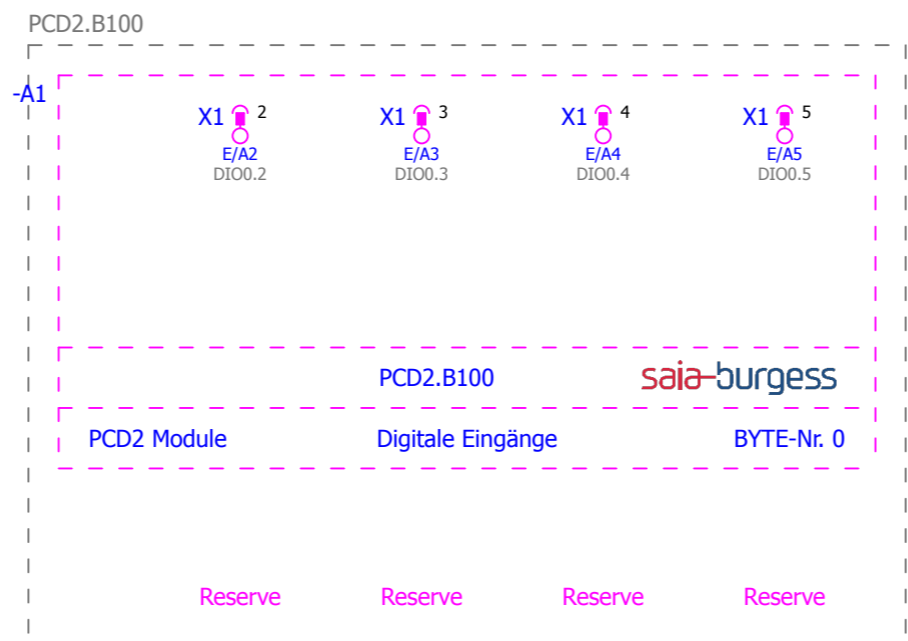

Saia-Burgess\PCD2 Module\PCD2.B100.ema
 Multi-line
 Variant C
 2012-10-26 / 2.1.4

1				for E/A2 to E/A5 delete if I/O is used as input		3		for E/A2 to E/A5 delete if I/O is used as output		
Änderung	Datum	Name	Urspr	Ersatz von	Ersetzt durch	EPLAN Software & Service Saia-Burgess Makroprojekt		Saia-Burgess Controls Ltd.		
						EPLAN		Allpolig		
							= PCD2 Module			
							+ PCD2.B100		Blatt 2	
									Blatt 522	

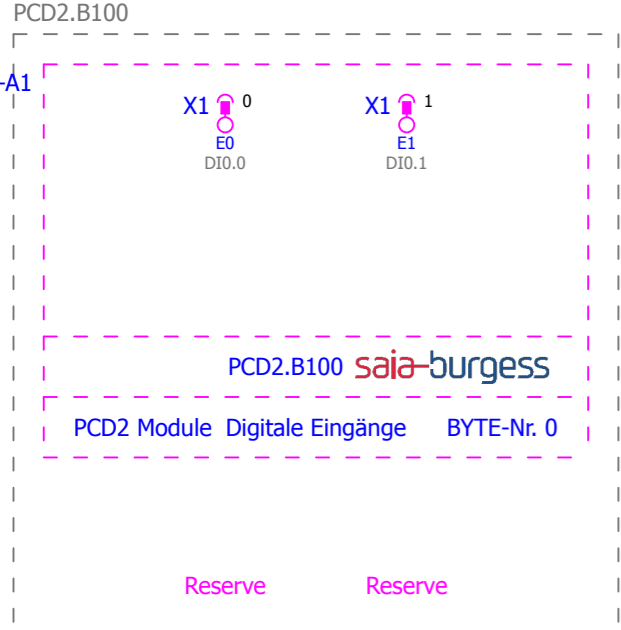

Saia-Burgess\PCD2 Module\PCD2.B100.ema
Multi-line
Variant D
2012-10-26 / 2.1.4

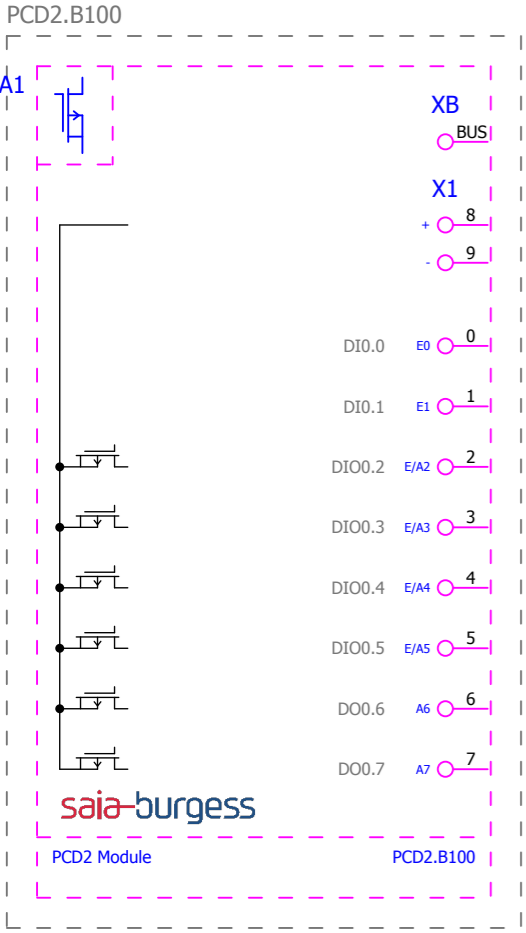

- XB**
BUS bus connector
- X1**
+ 8 24V DC
- 9
- DI0.0 E0 0 Reserve
- DI0.1 E1 1 Reserve
- DI0.2 E/A2 2 Reserve
- DI0.3 E/A3 3 Reserve
- DI0.4 E/A4 4 Reserve
- DI0.5 E/A5 5 Reserve
- DO0.6 A6 6 Reserve
- DO0.7 A7 7 Reserve

Saia-Burgess\PCD2 Module\PCD2.B100.ema
 Overview
 Variant A
 2012-10-26 / 2.1.4

			Datum	26.10.2012	EPLAN Software & Service Saia-Burgess Makroprojekt	Saia-Burgess Controls Ltd. Control Systems and Components	Saia-Burgess Controls Ltd.	SPS-Übersicht	= PCD2 Module		Blatt 10
			Bearb.	KAF					+ PCD2.B100		
			Gepr								
Änderung	Datum	Name	Urspr		Ersatz von	Ersetzt durch				Blatt	522

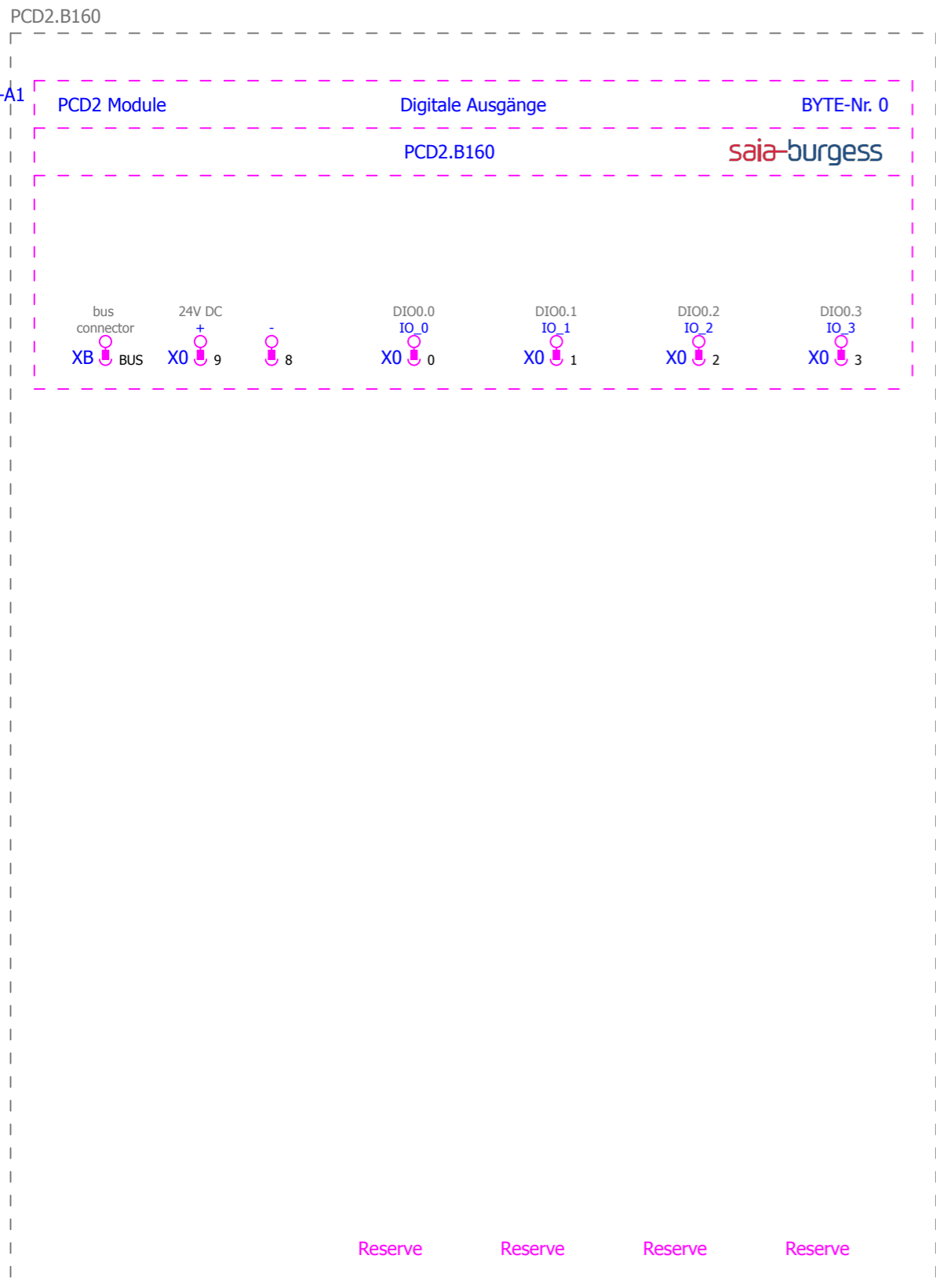

Saia-Burgess\PCD2 Module\PCD2.B160.ema
 Multi-line
 Variant A
 2012-10-26 / 2.1.4

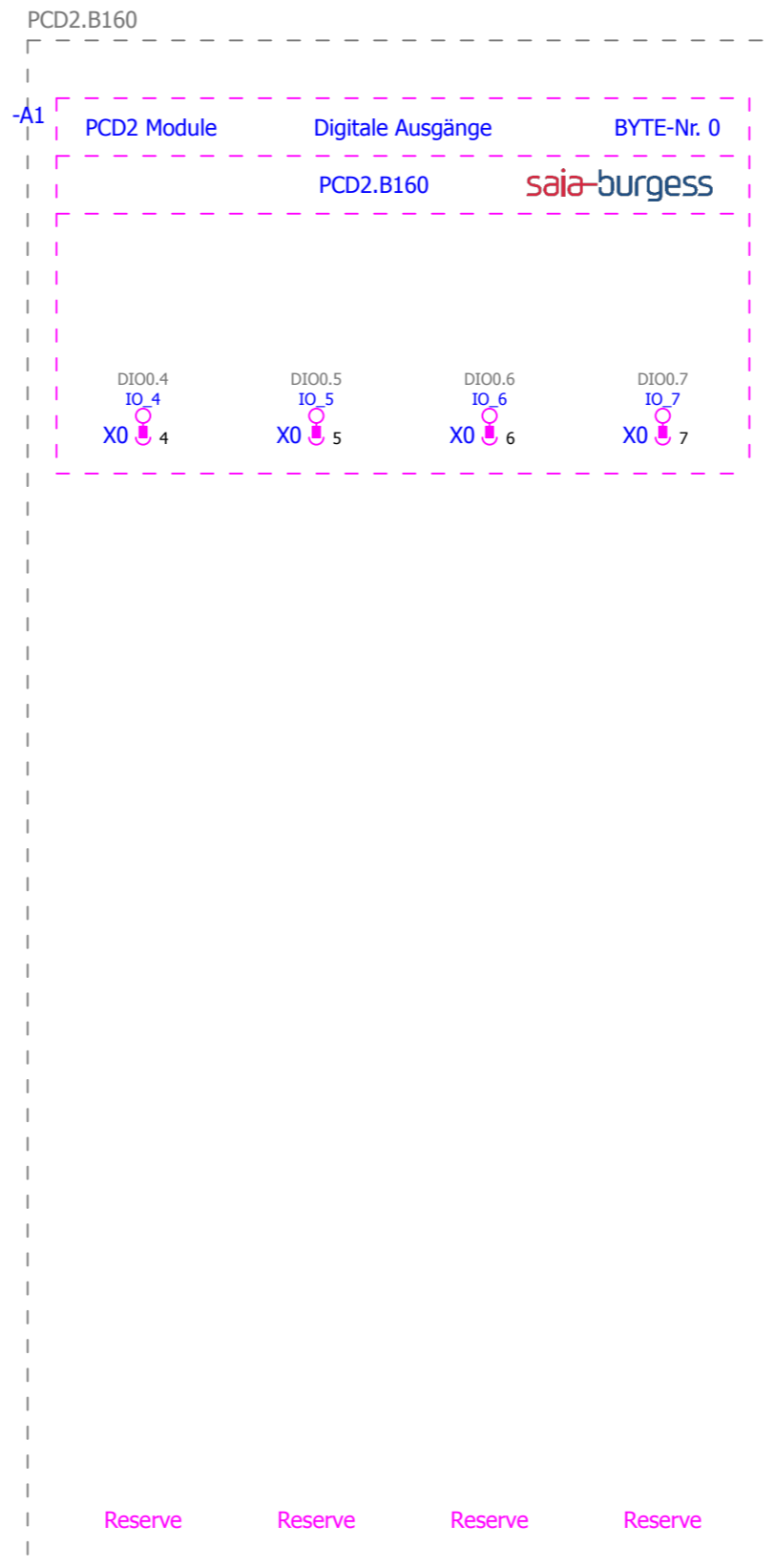

Saia-Burgess\PCD2 Module\PCD2.B160.ema
 Multi-line
 Variant B
 2012-10-26 / 2.1.4

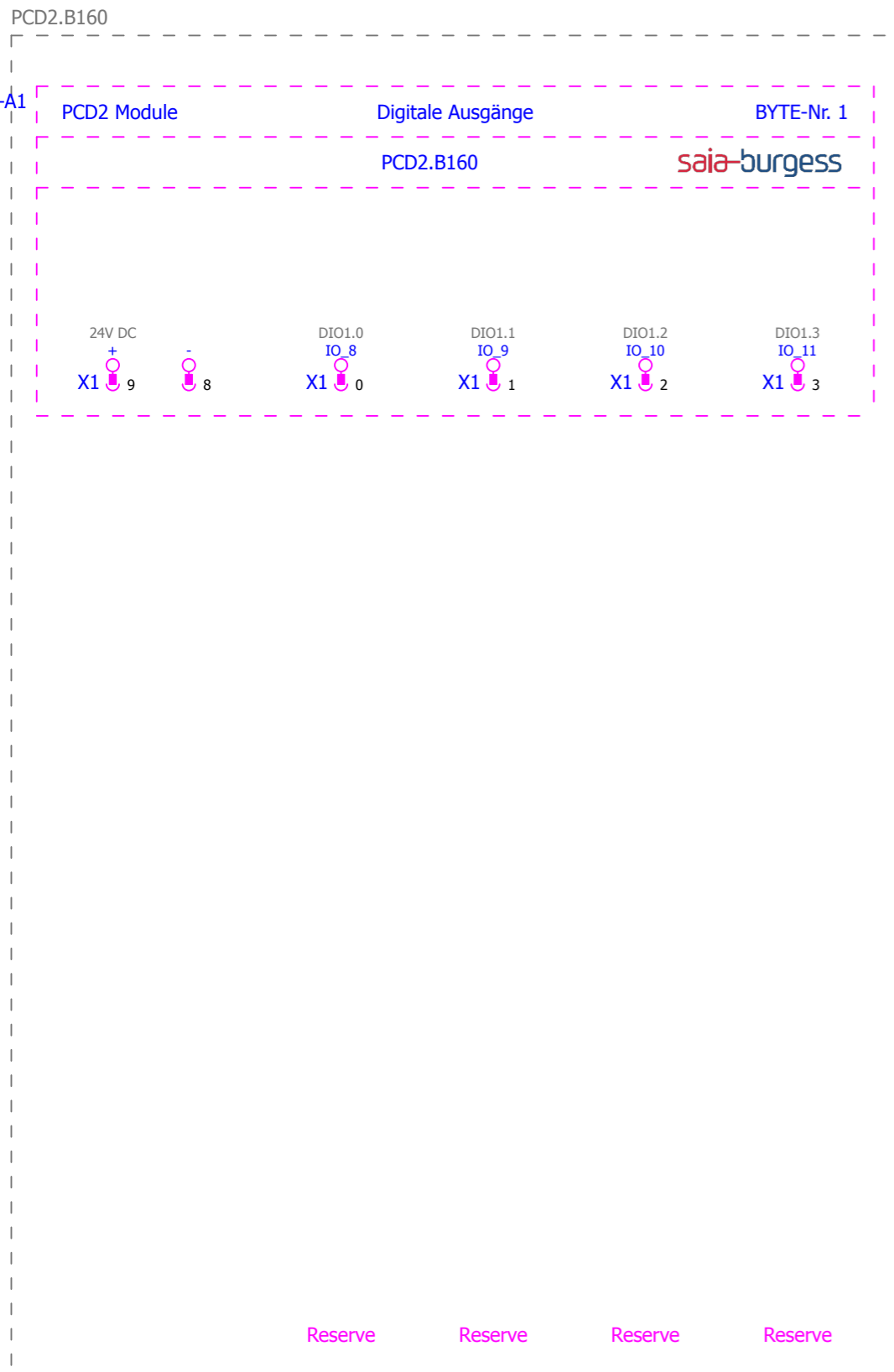

Saia-Burgess\PCD2 Module\PCD2.B160.ema
Multi-line
Variant C
2012-10-26 / 2.1.4

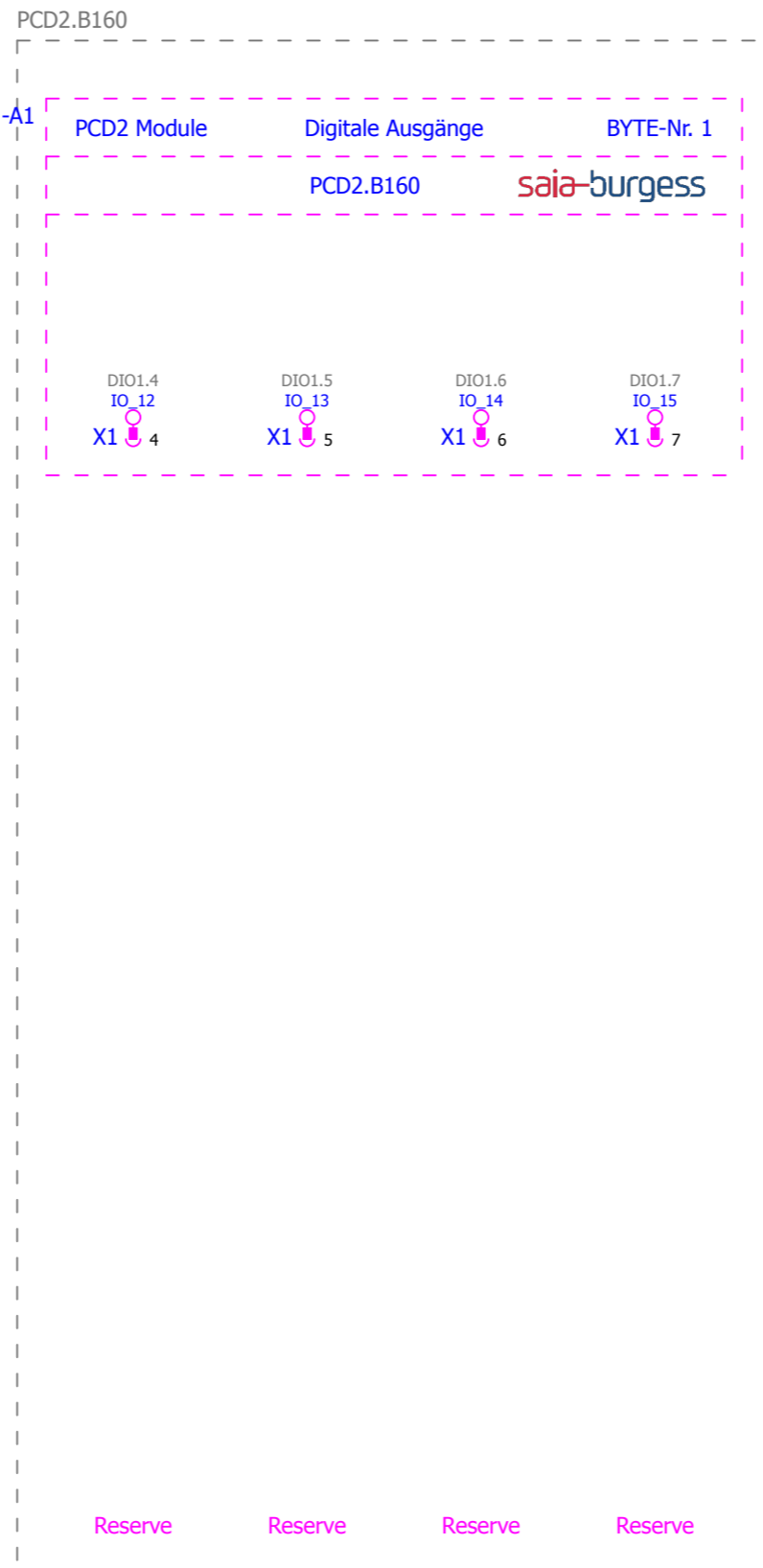

Saia-Burgess\PCD2 Module\PCD2.B160.ema
Multi-line
Variant D
2012-10-26 / 2.1.4

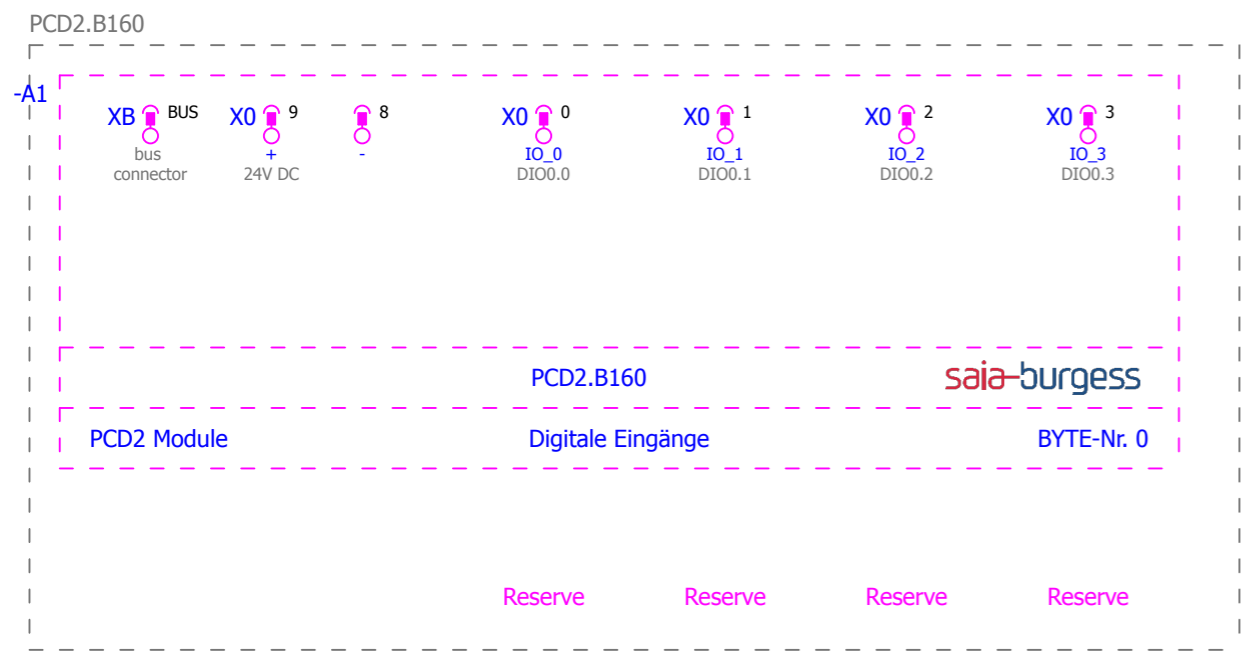

Saia-Burgess\PCD2 Module\PCD2.B160.ema
 Multi-line
 Variant E
 2012-10-26 / 2.1.4

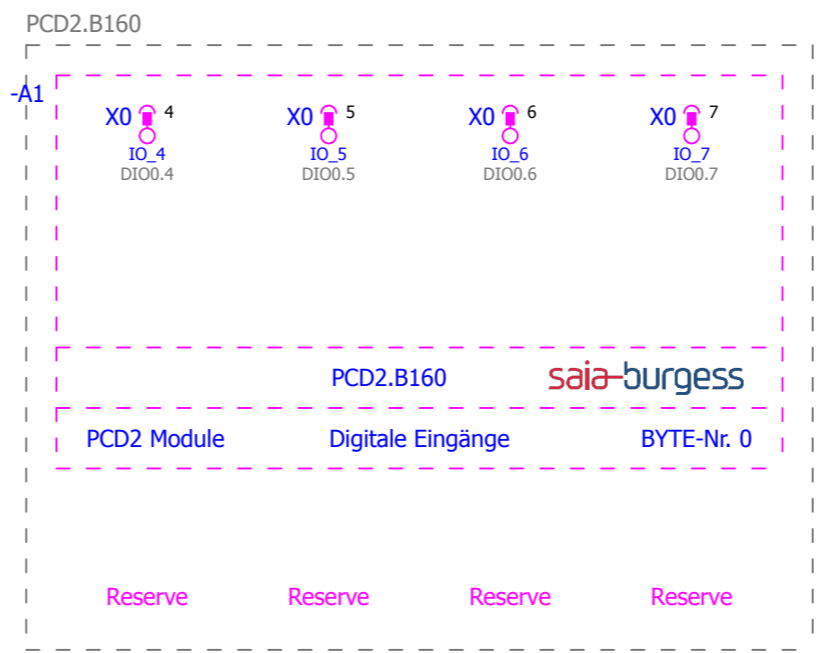

Saia-Burgess\PCD2 Module\PCD2.B160.ema
 Multi-line
 Variant F
 2012-10-26 / 2.1.4

			Datum	26.10.2012	EPLAN Software & Service Saia-Burgess Makroprojekt	Saia-Burgess Controls Ltd. Control Systems and Components	Saia-Burgess Controls Ltd.	Allpolig	= PCD2 Module	
		Bearb.	KAF	+ PCD2.B160						
		Gepr		Blatt					3	
Änderung	Datum	Name	Urspr	Ersatz von	Ersetzt durch				Blatt	522

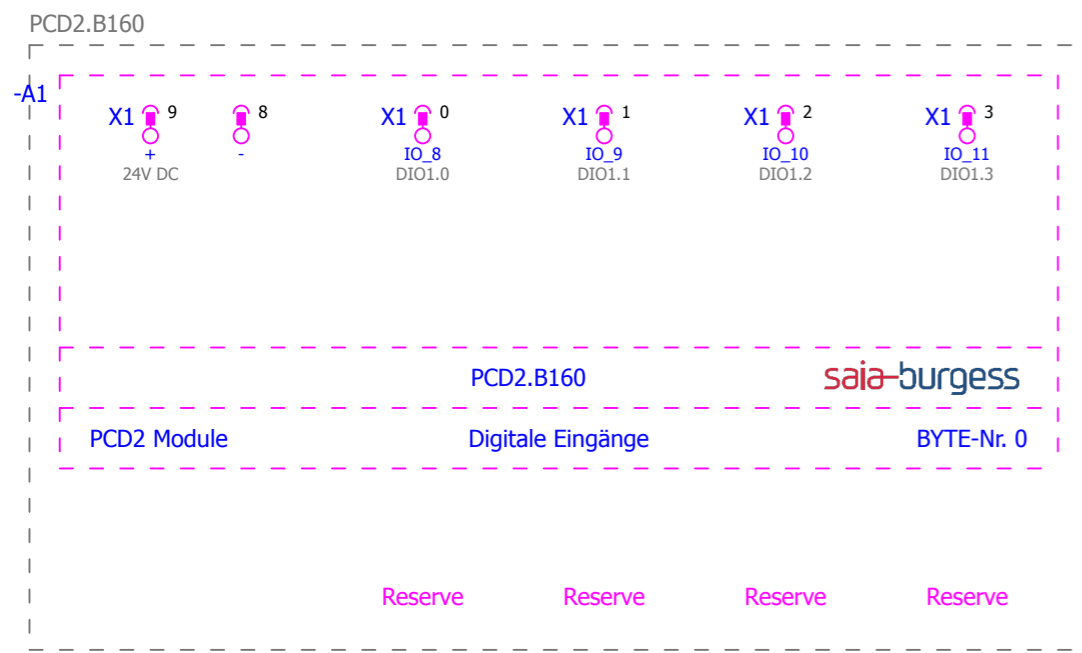

Saia-Burgess\PCD2 Module\PCD2.B160.ema
 Multi-line
 Variant G
 2012-10-26 / 2.1.4

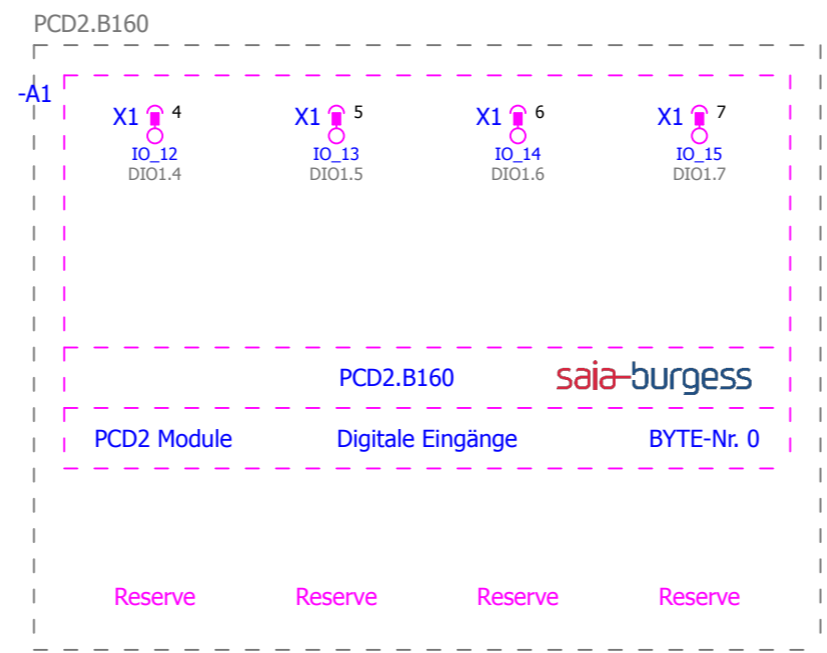

Saia-Burgess\PCD2 Module\PCD2.B160.ema
 Multi-line
 Variant H
 2012-10-26 / 2.1.4

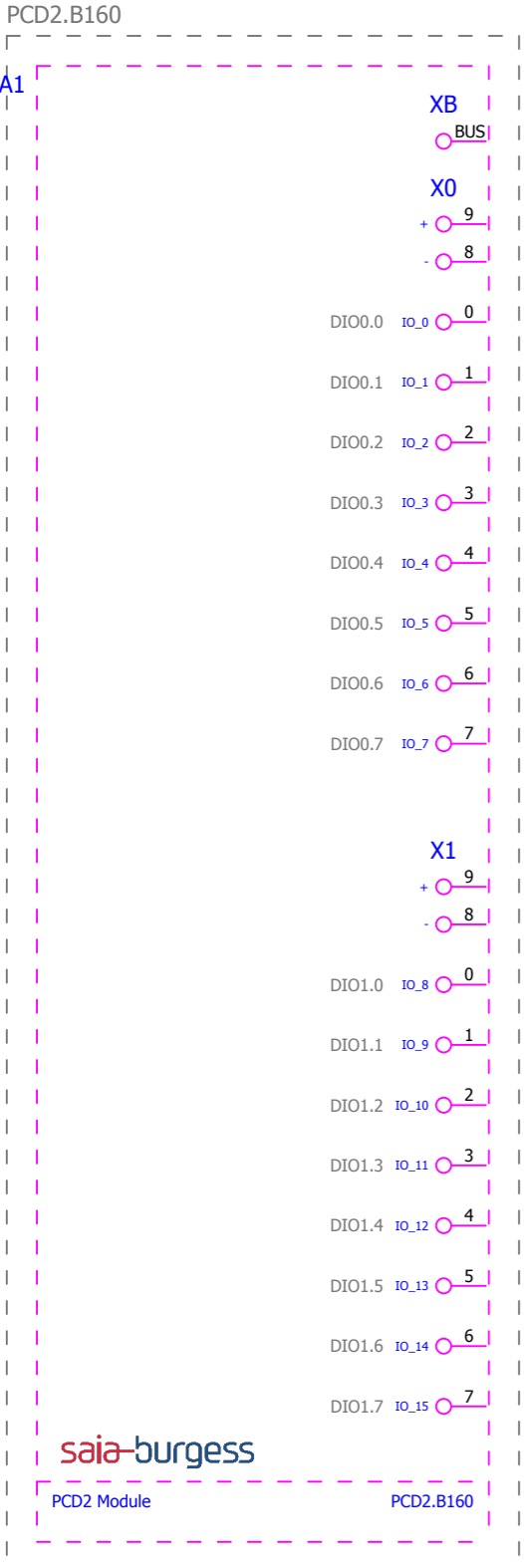

bus connector
 24V DC
 Reserve
 Reserve
 Reserve
 Reserve
 Reserve
 Reserve
 Reserve
 Reserve
 Reserve
 Reserve
 Reserve
 Reserve
 Reserve
 Reserve

Saia-Burgess\PCD2 Module\PCD2.B160.ema
 Overview
 Variant A
 2012-10-26 / 2.1.4

			Datum	26.10.2012	EPLAN Software & Service Saia-Burgess Makroprojekt	Saia-Burgess Controls Ltd. Control Systems and Components	Saia-Burgess Controls Ltd.	SPS-Übersicht	= PCD2 Module		Blatt 10
			Bearb.	KAF					+ PCD2.B160		
			Gepr								
Änderung	Datum	Name	Ürspr	Ersatz von	Ersetzt durch					Blatt 522	

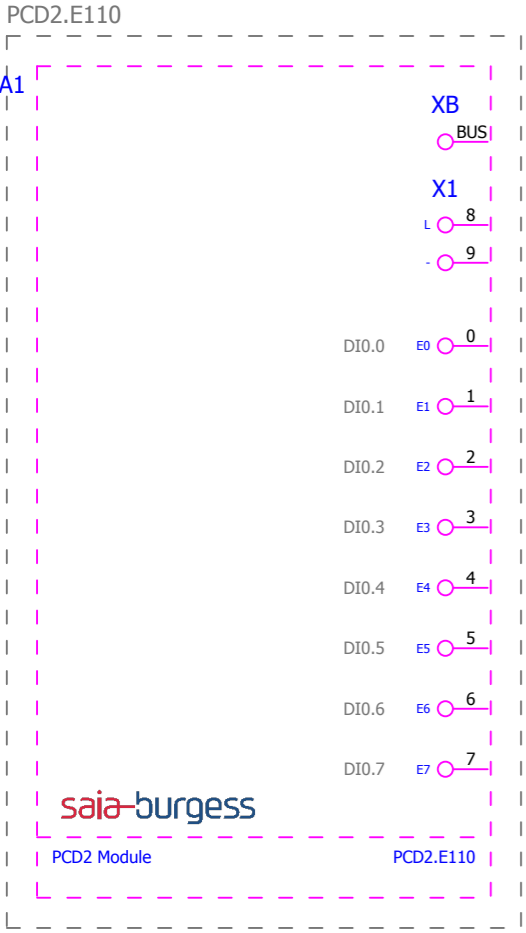

bus connector

Reserve

Reserve

Reserve

Reserve

Reserve

Reserve

Reserve

Reserve

Reserve

Saia-Burgess\PCD2 Module\PCD2.E110.ema
 Overview
 Variant A
 2012-10-26 / 2.1.4

			Datum	26.10.2012	EPLAN Software & Service Saia-Burgess Makroprojekt	Saia-Burgess Controls Ltd. Control Systems and Components	Saia-Burgess Controls Ltd.	SPS-Übersicht	= PCD2 Module		Blatt 10
			Bearb.	KAF					+ PCD2.E110		
			Gepr								
Änderung	Datum	Name	Urspr		Ersatz von	Ersetzt durch					

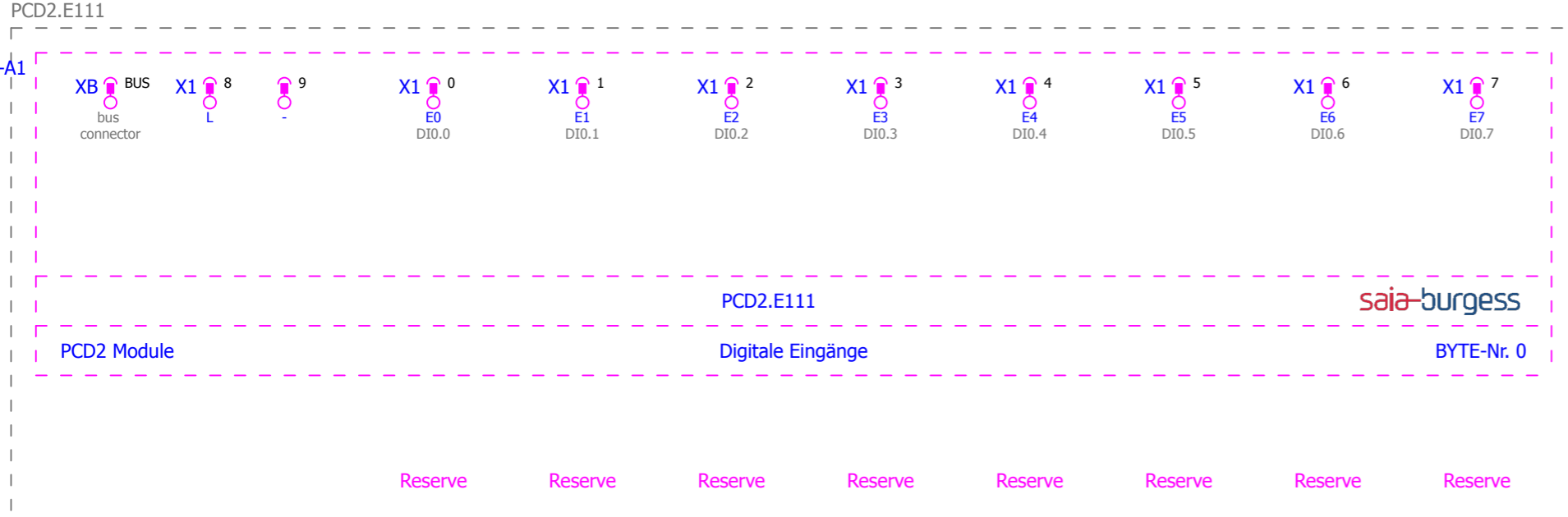

Saia-Burgess\PCD2 Module\PCD2.E111.ema
 Multi-line
 Variant A
 2012-10-26 / 2.1.4

+.E110/10

10

			Datum	26.10.2012	EPLAN Software & Service Saia-Burgess Makroprojekt	Saia-Burgess Controls Ltd. Control Systems and Components	Saia-Burgess Controls Ltd.	Allpolig	= PCD2 Module	
		Bearb.	KAF	+ PCD2.E111						
		Gepr		Blatt					1	
Änderung	Datum	Name	Urspr	Ersatz von	Ersetzt durch				Blatt	522

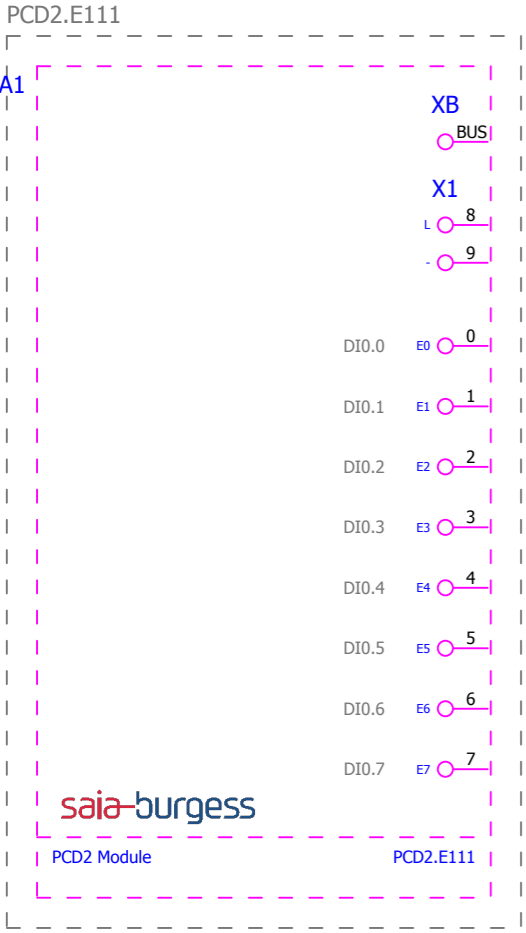

bus connector

Reserve

Reserve

Reserve

Reserve

Reserve

Reserve

Reserve

Reserve

Reserve

Saia-Burgess\PCD2 Module\PCD2.E111.ema
Overview
Variant A
2012-10-26 / 2.1.4

			Datum	26.10.2012	EPLAN Software & Service Saia-Burgess Makroprojekt	Saia-Burgess Controls Ltd. Control Systems and Components	Saia-Burgess Controls Ltd.	SPS-Übersicht	= PCD2 Module		Blatt 10
			Bearb.	KAF					+ PCD2.E111		
			Gepr								
Änderung	Datum	Name	Urspr		Ersatz von	Ersetzt durch				Blatt	522

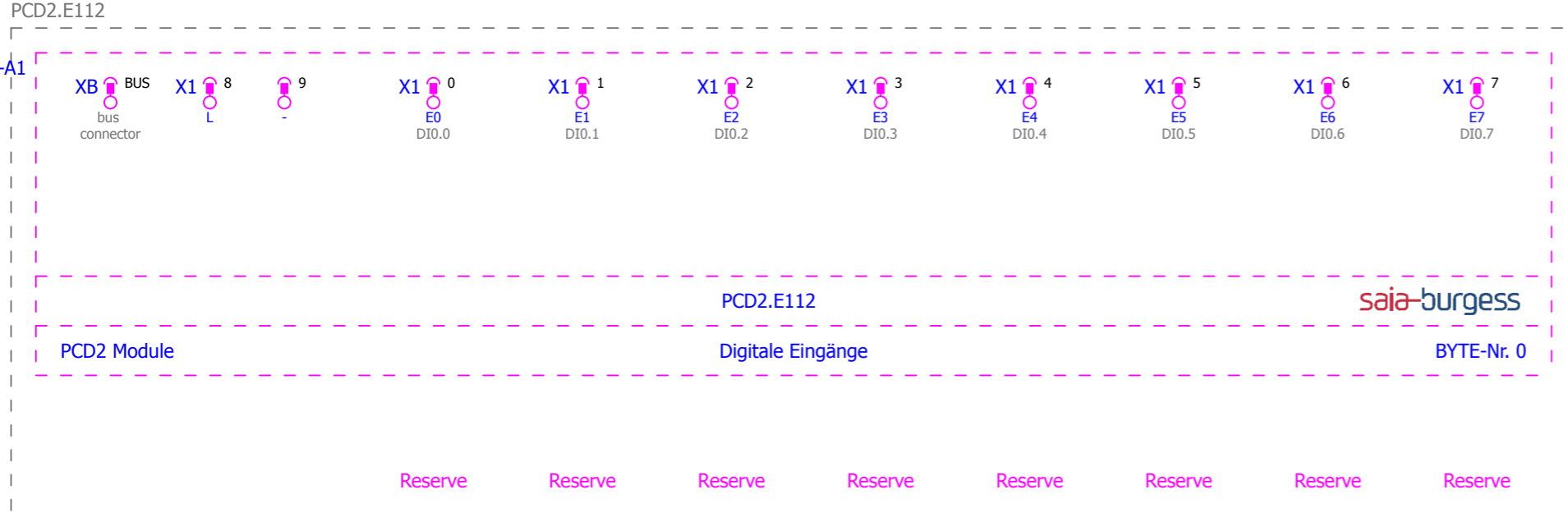

Saia-Burgess\PCD2 Module\PCD2.E112.ema
 Multi-line
 Variant A
 2012-10-26 / 2.1.4

+.E111/10

10

			Datum	26.10.2012	EPLAN Software & Service Saia-Burgess Makroprojekt	 Control Systems and Components	Saia-Burgess Controls Ltd.	Allpolig	= PCD2 Module	
		Bearb.	KAF	+ PCD2.E112						
		Gepr		Blatt					1	
Änderung	Datum	Name	Urspr	Ersatz von	Ersetzt durch				Blatt	522

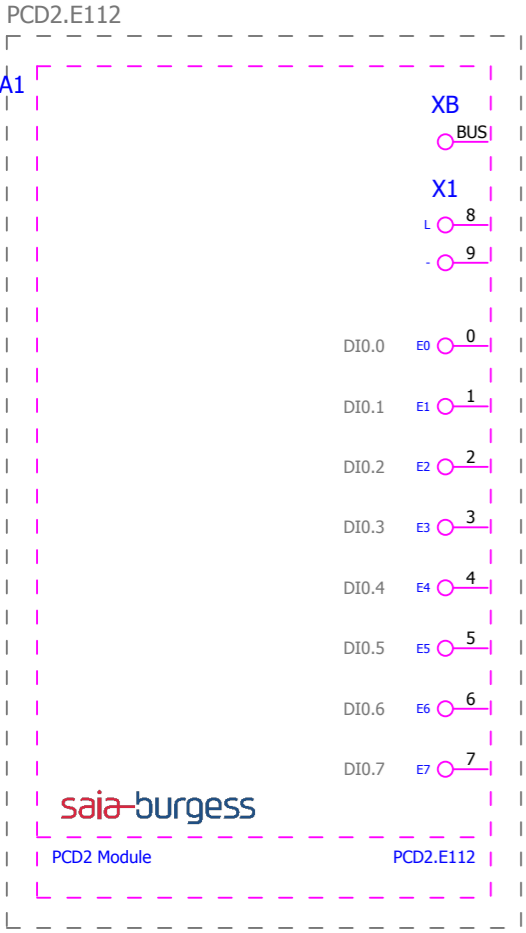

bus connector

Reserve

Reserve

Reserve

Reserve

Reserve

Reserve

Reserve

Reserve

Reserve

Saia-Burgess\PCD2 Module\PCD2.E112.ema
 Overview
 Variant A
 2012-10-26 / 2.1.4

			Datum	26.10.2012	EPLAN Software & Service Saia-Burgess Makroprojekt	Saia-Burgess Controls Ltd. Control Systems and Components	Saia-Burgess Controls Ltd.	SPS-Übersicht	= PCD2 Module		Blatt 10
			Bearb.	KAF					+ PCD2.E112		
			Gepr								
Änderung	Datum	Name	Urspr		Ersatz von	Ersetzt durch					

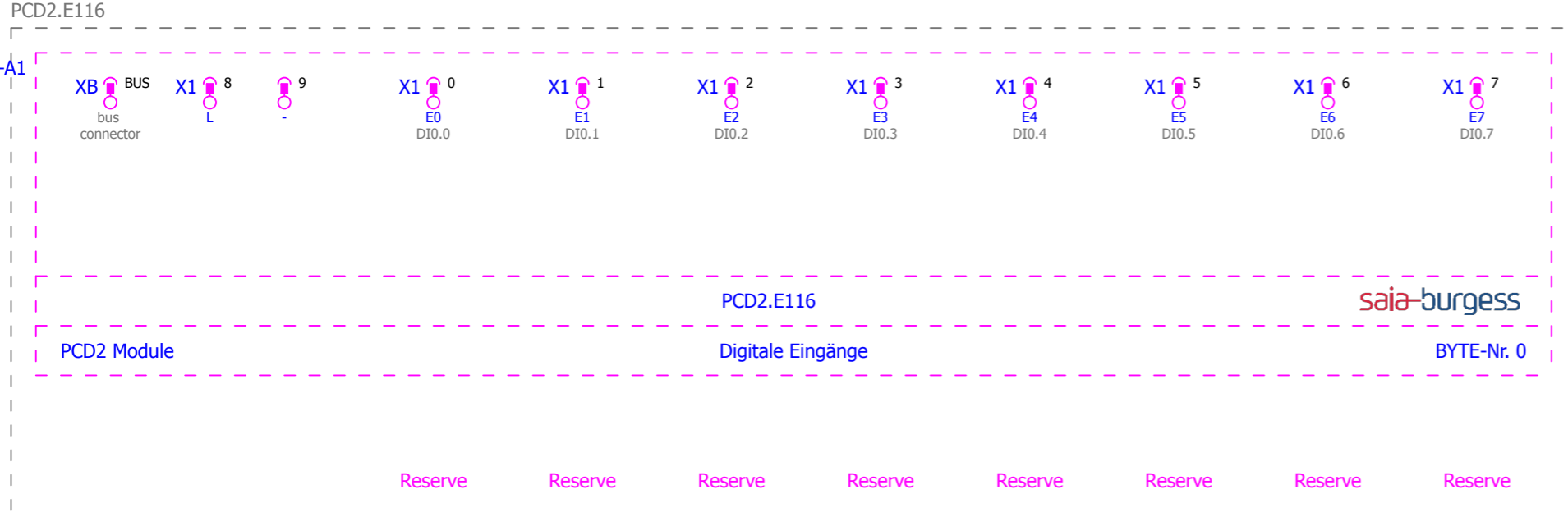

Saia-Burgess\PCD2 Module\PCD2.E116.ema
Multi-line
Variant A
2012-10-26 / 2.1.4

+.E112/10

			Datum	26.10.2012	EPLAN Software & Service Saia-Burgess Makroprojekt	 Control Systems and Components	Saia-Burgess Controls Ltd.	Allpolig	= PCD2 Module	
		Bearb.	KAF	+ PCD2.E116						
		Gepr		Blatt					1	
Änderung	Datum	Name	Urspr	Ersatz von	Ersetzt durch				Blatt	522

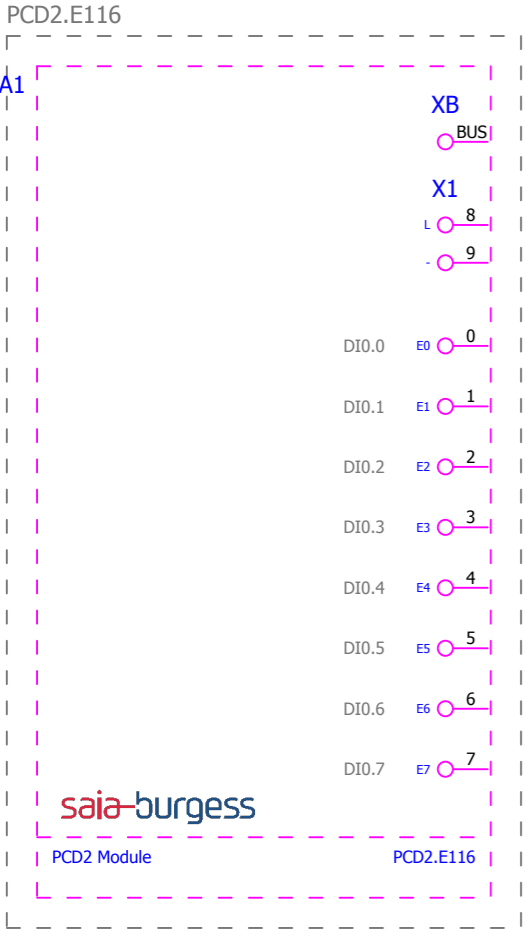

Saia-Burgess\PCD2 Module\PCD2.E116.ema
 Overview
 Variant A
 2012-10-26 / 2.1.4

- bus connector
- Reserve
- Reserve
- Reserve
- Reserve
- Reserve
- Reserve
- Reserve
- Reserve
- Reserve

			Datum	26.10.2012	EPLAN Software & Service Saia-Burgess Makroprojekt	Saia-Burgess Controls Ltd. <small>Control Systems and Components</small>	Saia-Burgess Controls Ltd.	SPS-Übersicht	= PCD2 Module		Blatt 10
			Bearb.	KAF					+ PCD2.E116		
			Gepr								
Änderung	Datum	Name	Urspr		Ersatz von	Ersetzt durch				Blatt	522

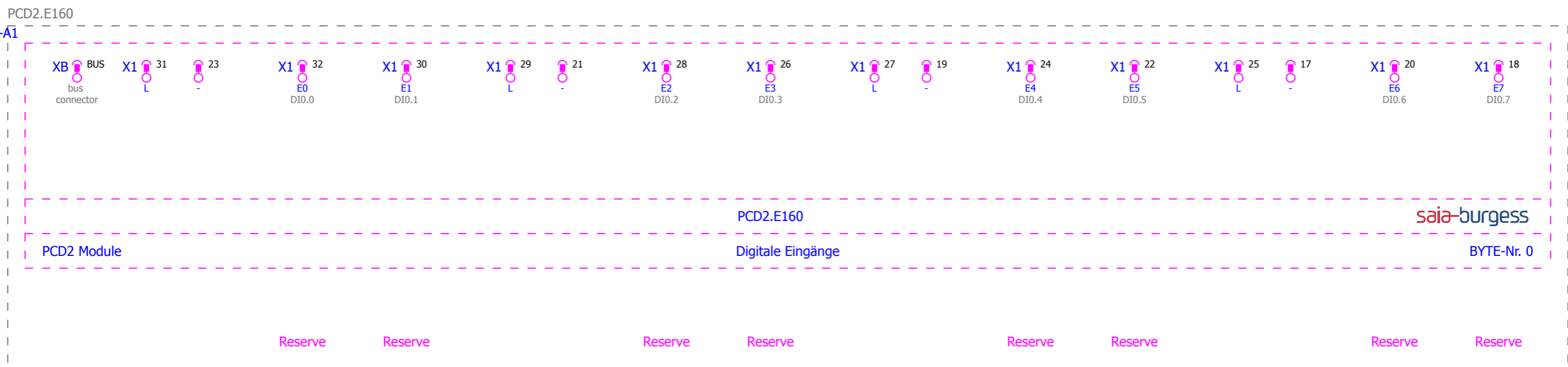

Saia-Burgess\PCD2 Module\PCD2.E160.ema
Multi-line
Variant A
2012-10-26 / 2.1.4

+.E116/10

			Datum	26.10.2012	EPLAN Software & Service Saia-Burgess Makroprojekt	 Control Systems and Components	Saia-Burgess Controls Ltd.	Allpolig	= PCD2 Module		Blatt 1
		Bearb.	KAF	+ PCD2.E160					Blatt 522		
		Gepr									
Änderung	Datum	Name	Urspr	Ersatz von	Ersetzt durch						

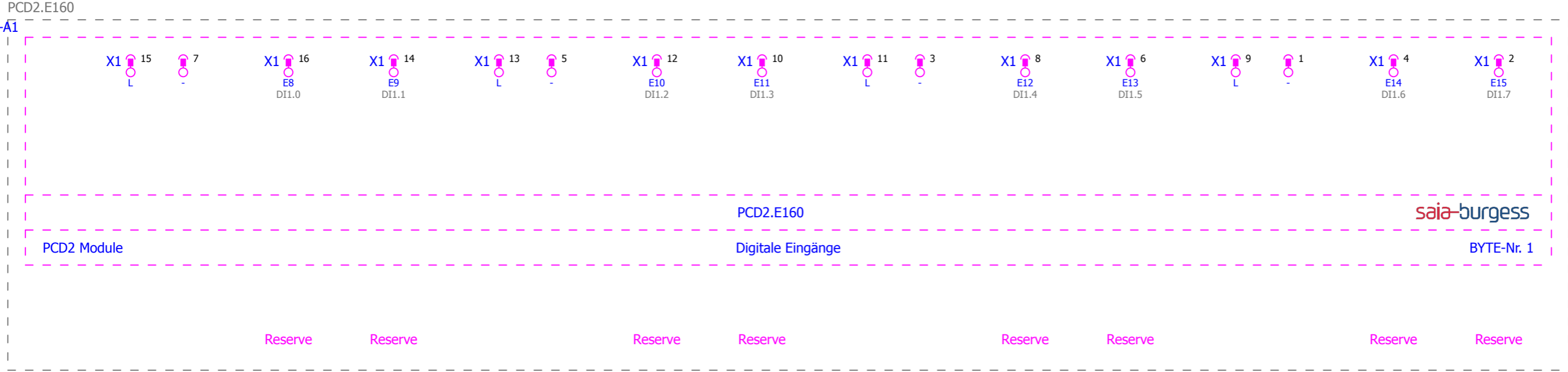

Saia-Burgess\PCD2 Module\PCD2.E160.ema
 Multi-line
 Variant B
 2012-10-26 / 2.1.4

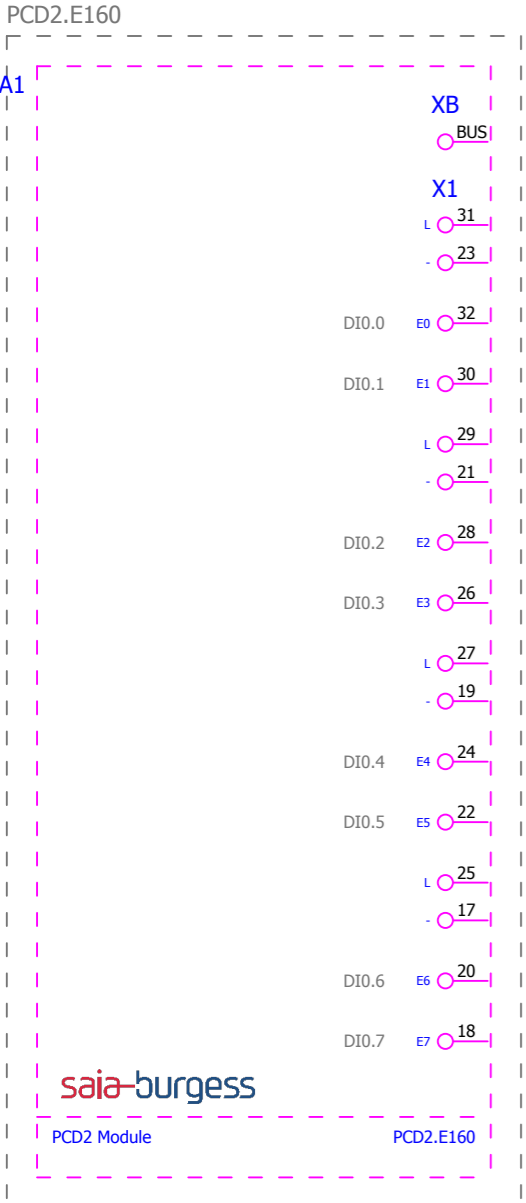

Saia-Burgess\PCD2 Module\PCD2.E160.ema
 Overview
 Variant A
 2012-10-26 / 2.1.4

bus connector

Reserve

Reserve

Reserve

Reserve

Reserve

Reserve

Reserve

Reserve

Reserve

Reserve

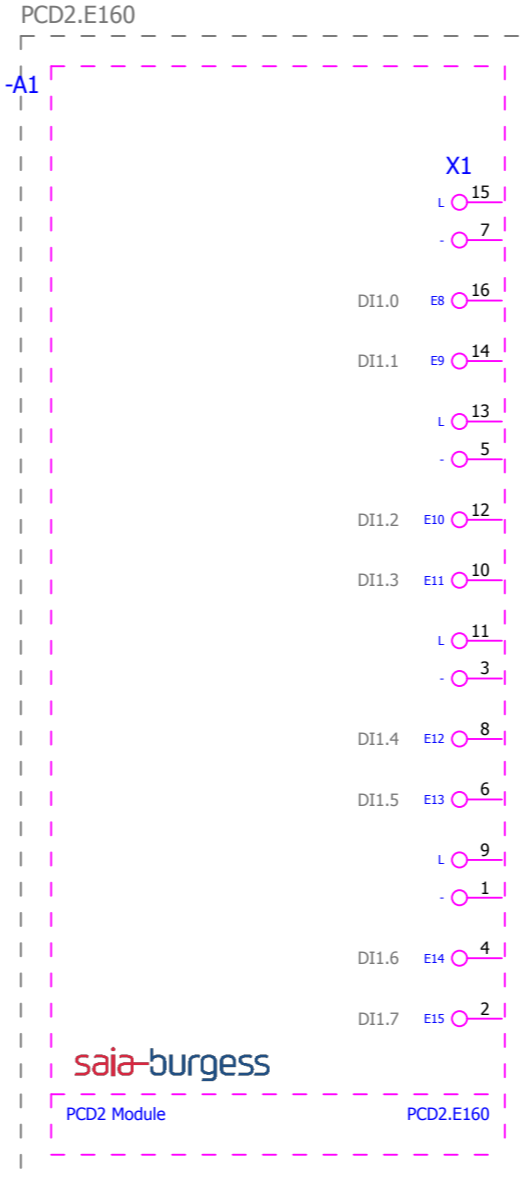

Saia-Burgess\PCD2 Module\PCD2.E160.ema
 Overview
 Variant B
 2012-10-26 / 2.1.4

Reserve

Reserve

Reserve

Reserve

Reserve

Reserve

Reserve

Reserve

			Datum	26.10.2012	EPLAN Software & Service Saia-Burgess Makroprojekt	Saia-Burgess Controls Ltd. Control Systems and Components	Saia-Burgess Controls Ltd.	SPS-Übersicht	= PCD2 Module	
			Bearb.	KAF					+ PCD2.E160	
			Gepr						Blatt	10
Änderung	Datum	Name	Ürspr		Ersatz von	Ersetzt durch			Blatt	522

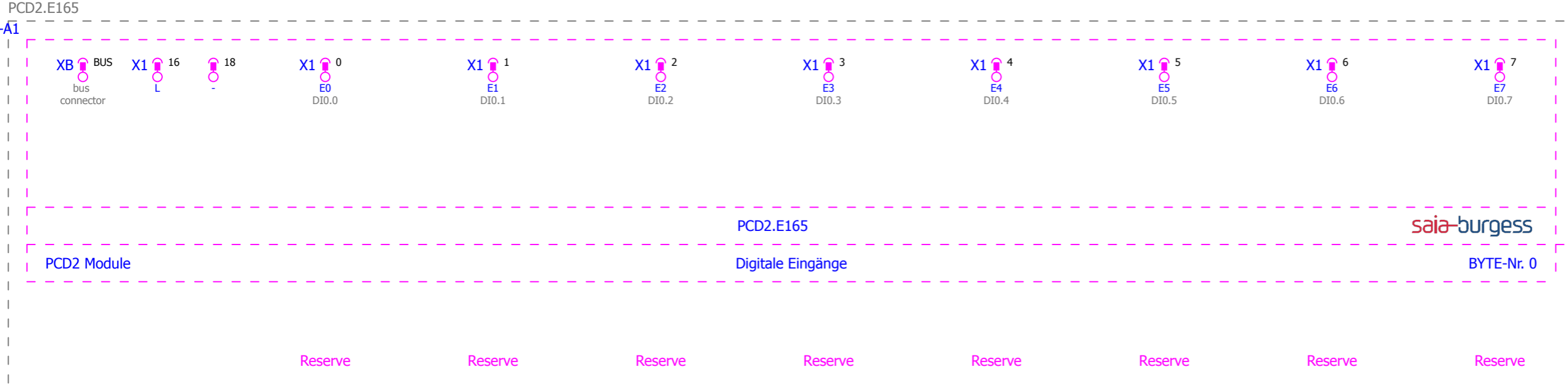

Saia-Burgess\PCD2 Module\PCD2.E165.ema
Multi-line
Variant A
2012-10-26 / 2.1.4

+.E160/10

			Datum	26.10.2012	EPLAN Software & Service Saia-Burgess Makroprojekt	 Control Systems and Components	Saia-Burgess Controls Ltd.	Allpolig	= PCD2 Module	
			Bearb.	KAF					+ PCD2.E165	
			Gepr							
Änderung	Datum	Name	Urspr		Ersatz von	Ersetzt durch			Blatt	1
									Blatt	522

PCD2.E165

-A1

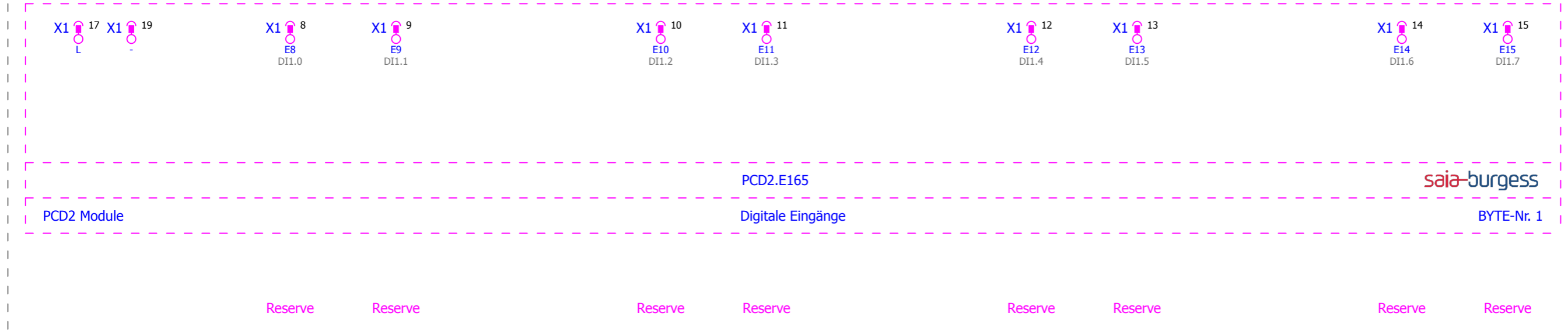

Saia-Burgess\PCD2 Module\PCD2.E165.ema
 Multi-line
 Variant B
 2012-10-26 / 2.1.4

			Datum	26.10.2012	EPLAN Software & Service Saia-Burgess Makroprojekt	Saia-Burgess Controls Ltd. Control Systems and Components	Allpolig	= PCD2 Module		Blatt 2
			Bearb.	KAF				+ PCD2.E165		
			Gepr							
Änderung	Datum	Name	Urspr	Ersatz von	Ersetzt durch			Blatt 522		

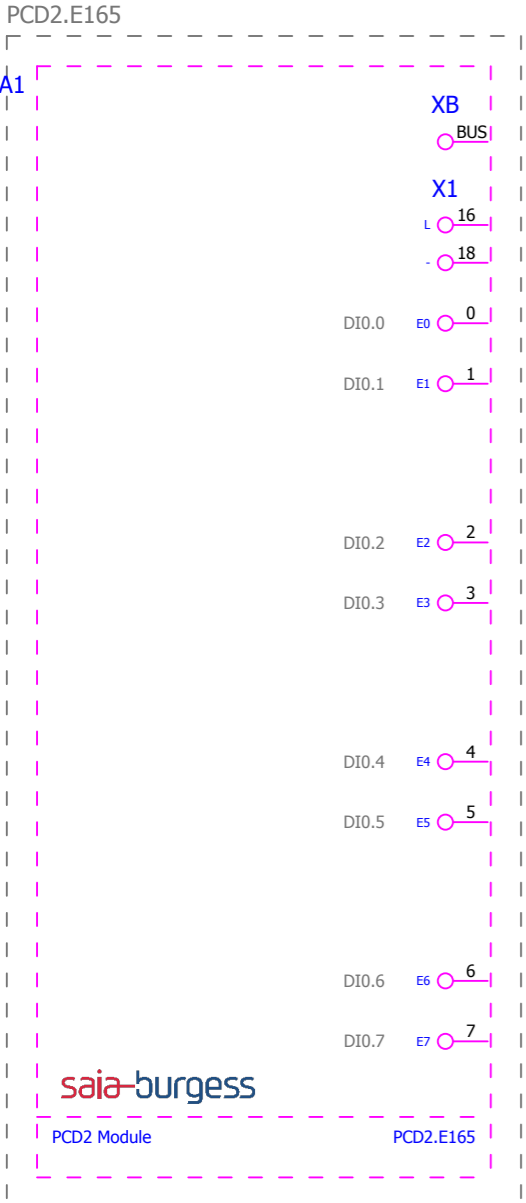

Saia-Burgess\PCD2 Module\PCD2.E165.ema
 Overview
 Variant A
 2012-10-26 / 2.1.4

- bus connector
- Reserve
- Reserve
- Reserve
- Reserve
- Reserve
- Reserve
- Reserve
- Reserve
- Reserve

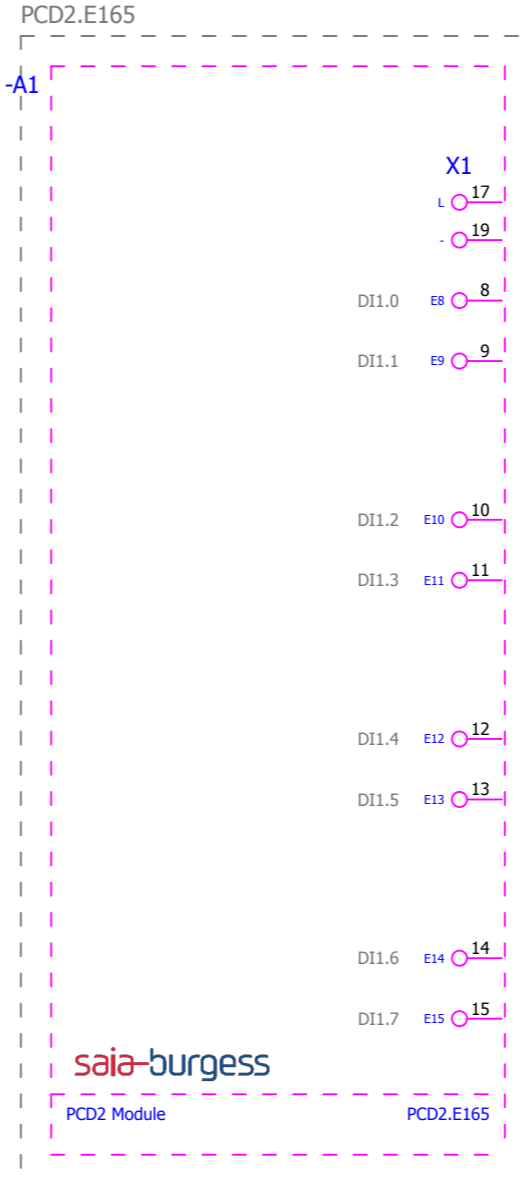

Saia-Burgess\PCD2 Module\PCD2.E165.ema
 Overview
 Variant B
 2012-10-26 / 2.1.4

- Reserve
- Reserve
- Reserve
- Reserve
- Reserve
- Reserve
- Reserve
- Reserve

			Datum	26.10.2012	EPLAN Software & Service Saia-Burgess Makroprojekt	Saia-Burgess Controls Ltd. Control Systems and Components	Saia-Burgess Controls Ltd.	SPS-Übersicht	= PCD2 Module	
			Bearb.	KAF					+ PCD2.E165	
			Gepr						Blatt	10
Änderung	Datum	Name	Urspr		Ersatz von	Ersetzt durch			Blatt	522

PCD2.E161

-A1

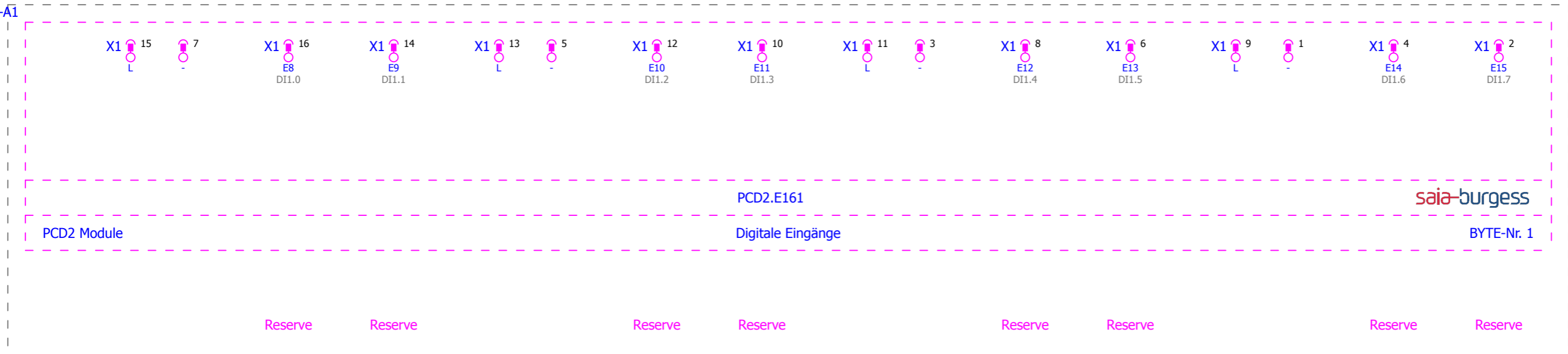

Saia-Burgess\PCD2 Module\PCD2.E161.ema
 Multi-line
 Variant B
 2012-10-26 / 2.1.4

			Datum	26.10.2012	EPLAN Software & Service Saia-Burgess Makroprojekt	Saia-Burgess Controls Ltd. Control Systems and Components	Saia-Burgess Controls Ltd.	Allpolig	= PCD2 Module		Blatt 2
			Bearb.	KAF					+ PCD2.E161		
			Gepr								
Änderung	Datum	Name	Urspr		Ersatz von	Ersetzt durch			Blatt 522		

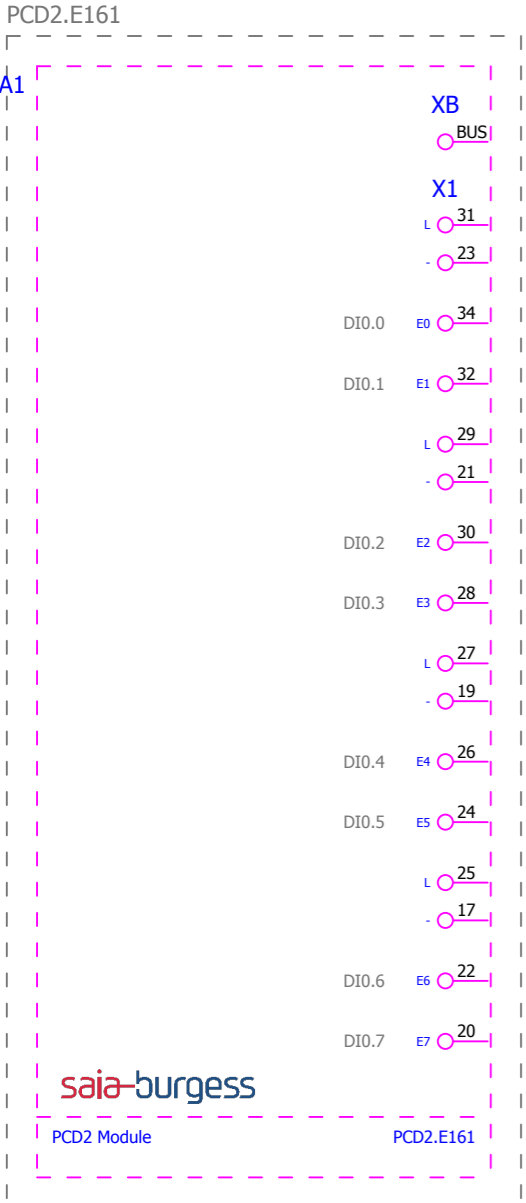

Saia-Burgess\PCD2 Module\PCD2.E161.ema
 Overview
 Variant A
 2012-10-26 / 2.1.4

- bus connector
- Reserve
- Reserve
- Reserve
- Reserve
- Reserve
- Reserve
- Reserve
- Reserve
- Reserve
- Reserve
- Reserve
- Reserve
- Reserve

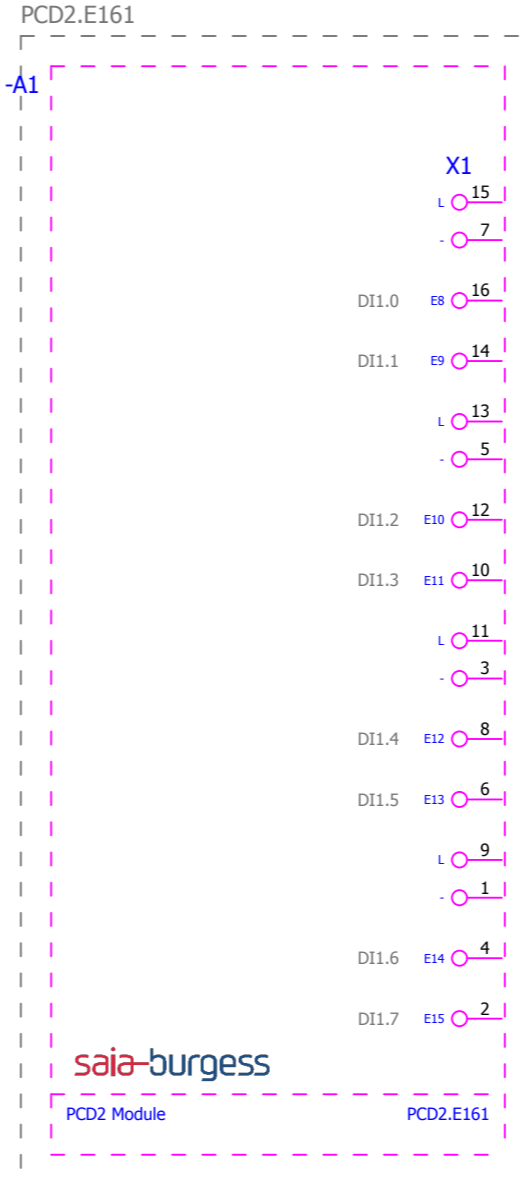

Saia-Burgess\PCD2 Module\PCD2.E161.ema
 Overview
 Variant B
 2012-10-26 / 2.1.4

- Reserve
- Reserve
- Reserve
- Reserve
- Reserve
- Reserve
- Reserve
- Reserve
- Reserve
- Reserve
- Reserve
- Reserve
- Reserve
- Reserve

			Datum	26.10.2012	EPLAN Software & Service Saia-Burgess Makroprojekt <small>Control Systems and Components</small>	Saia-Burgess Controls Ltd.	SPS-Übersicht	= PCD2 Module	
			Bearb.	KAF				+ PCD2.E161	
			Gepr					Blatt	10
Änderung	Datum	Name	Urspr		Ersatz von	Ersetzt durch		Blatt	522

PCD2.E166

-A1



PCD2 Module

PCD2.E166

saia-burgess

Digitale Eingänge

BYTE-Nr. 1

Reserve

Reserve

Reserve

Reserve

Reserve

Reserve

Reserve

Reserve

Saia-Burgess\PCD2 Module\PCD2.E166.ema
 Multi-line
 Variant B
 2012-10-26 / 2.1.4

			Datum	26.10.2012	EPLAN Software & Service Saia-Burgess Makroprojekt	 Control Systems and Components	Saia-Burgess Controls Ltd.	Allpolig	= PCD2 Module	
			Bearb.	KAF					+ PCD2.E166	
			Gepr							
Änderung	Datum	Name	Urspr		Ersatz von	Ersetzt durch			Blatt	2
									Blatt	522

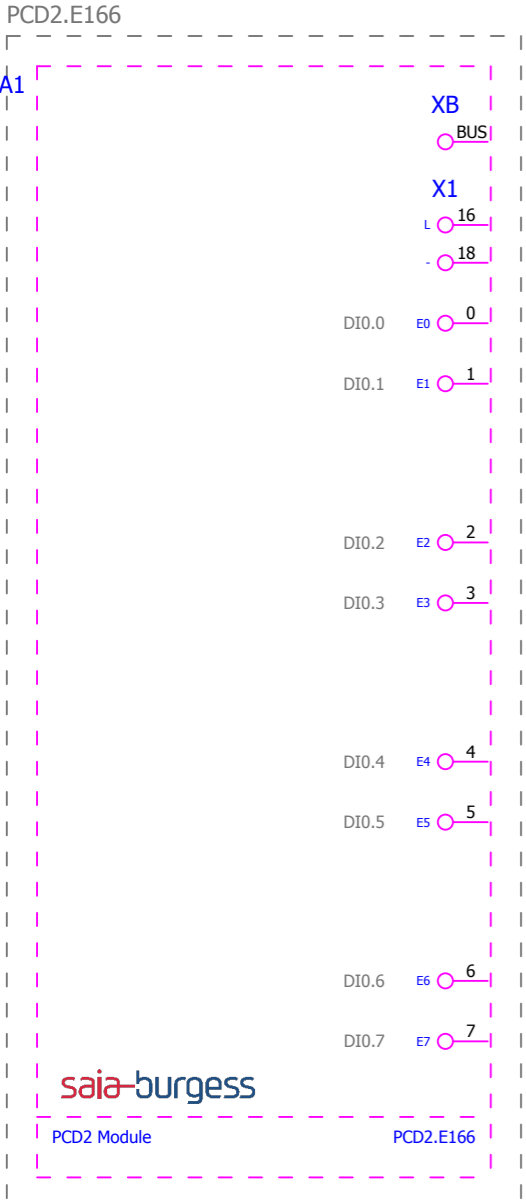

Saia-Burgess\PCD2 Module\PCD2.E166.ema
 Overview
 Variant A
 2012-10-26 / 2.1.4

- bus connector
- Reserve
- Reserve
- Reserve
- Reserve
- Reserve
- Reserve
- Reserve
- Reserve
- Reserve

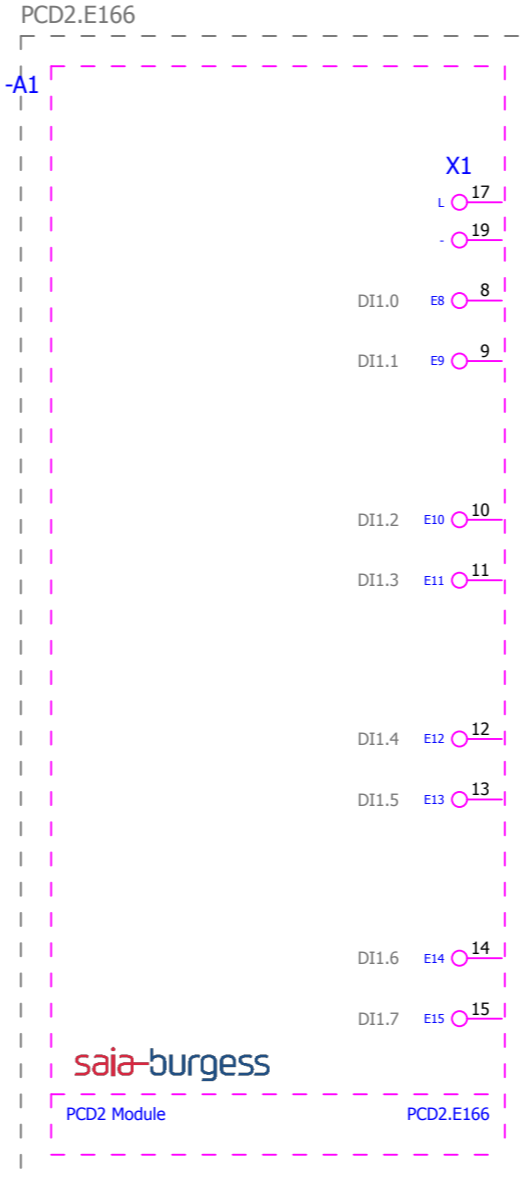

Saia-Burgess\PCD2 Module\PCD2.E166.ema
 Overview
 Variant B
 2012-10-26 / 2.1.4

- Reserve
- Reserve
- Reserve
- Reserve
- Reserve
- Reserve
- Reserve
- Reserve

			Datum	26.10.2012	EPLAN Software & Service Saia-Burgess Makroprojekt	Saia-Burgess Controls Ltd. Control Systems and Components	Saia-Burgess Controls Ltd.	SPS-Übersicht	= PCD2 Module	
		Bearb.	KAF	+ PCD2.E166						
		Gepr		Blatt					10	
Änderung	Datum	Name	Ürspr	Ersatz von	Ersetzt durch				Blatt	522

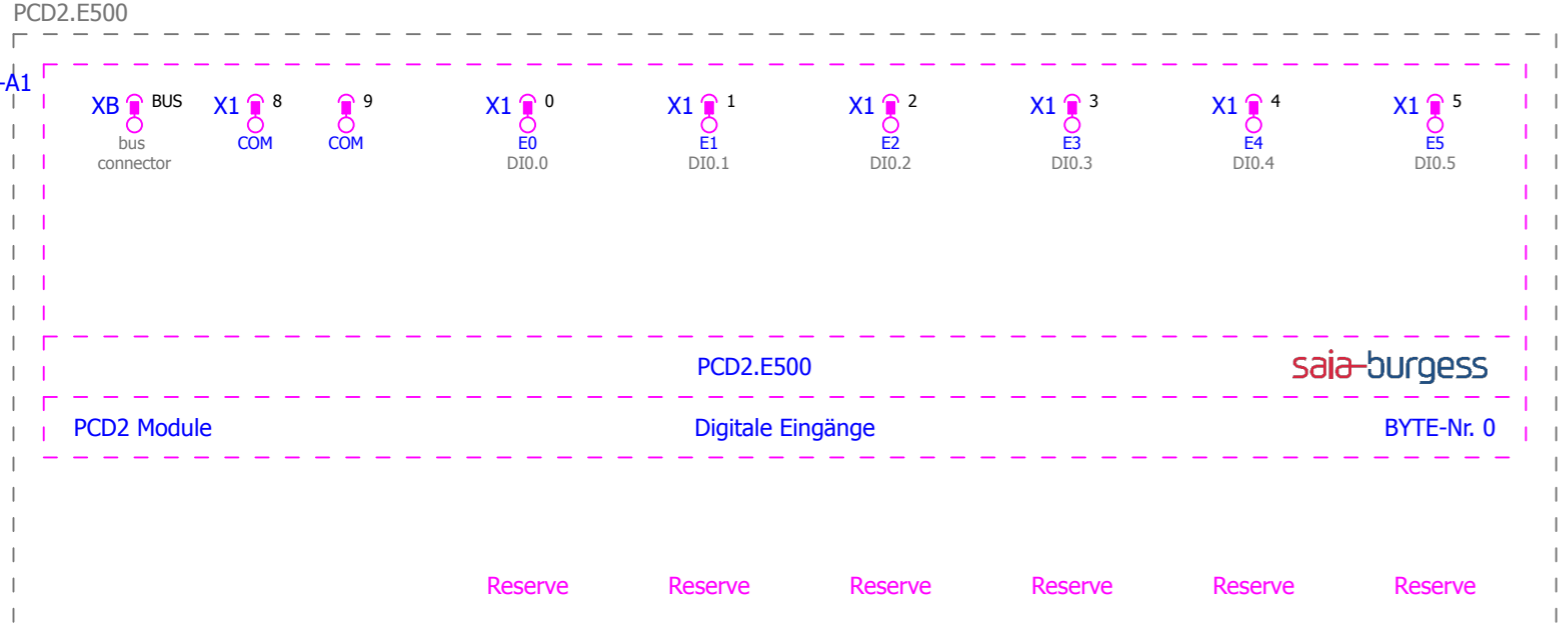

Saia-Burgess\PCD2 Module\PCD2.E500.ema
Multi-line
Variant A
2012-10-26 / 2.1.4

+..E166/10

			Datum	26.10.2012	EPLAN Software & Service Saia-Burgess Makroprojekt	 Control Systems and Components	Saia-Burgess Controls Ltd.	Allpolig		= PCD2 Module			
			Bearb.	KAF							+ PCD2.E500		
			Gepr										Blatt 1
Änderung	Datum	Name	Urspr		Ersatz von	Ersetzt durch					Blatt 522		

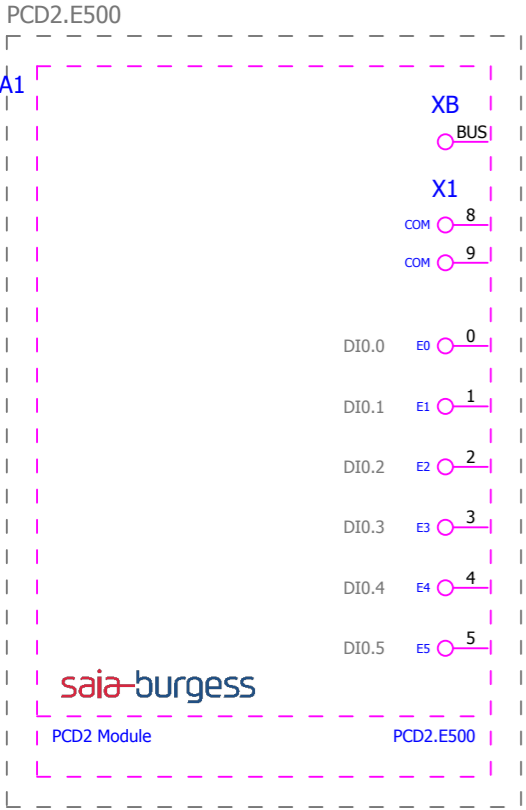

bus connector

Reserve

Reserve

Reserve

Reserve

Reserve

Reserve

Saia-Burgess\PCD2 Module\PCD2.E500.ema
 Overview
 Variant A
 2012-10-26 / 2.1.4

			Datum	26.10.2012	EPLAN Software & Service Saia-Burgess Makroprojekt	Saia-Burgess Controls Ltd. Control Systems and Components	Saia-Burgess Controls Ltd.	SPS-Übersicht	= PCD2 Module		Blatt 10
			Bearb.	KAF					+ PCD2.E500		
			Gepr								
Änderung	Datum	Name	Urspr		Ersatz von	Ersetzt durch				Blatt	522

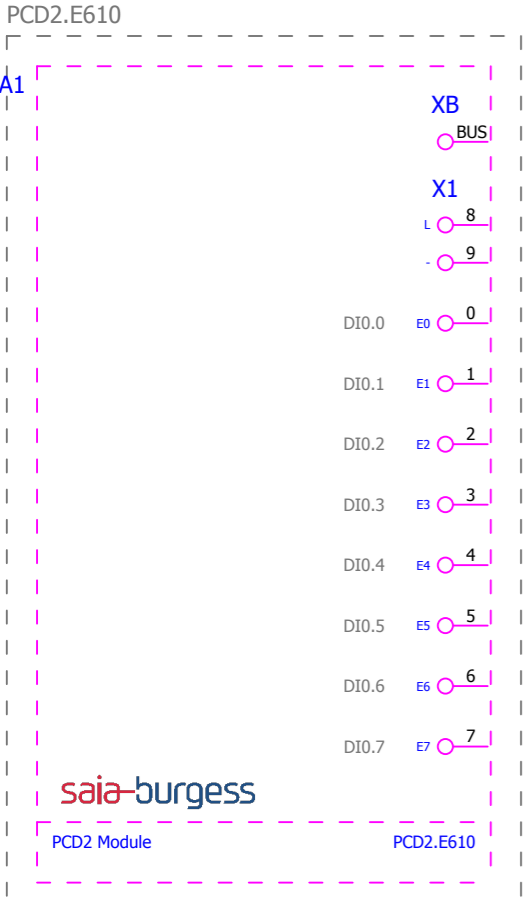

bus connector

Reserve

Reserve

Reserve

Reserve

Reserve

Reserve

Reserve

Reserve

Saia-Burgess\PCD2 Module\PCD2.E610.ema
 Overview
 Variant A
 2012-10-26 / 2.1.4

			Datum	26.10.2012	EPLAN Software & Service Saia-Burgess Makroprojekt	Saia-Burgess Controls Ltd. Control Systems and Components	Saia-Burgess Controls Ltd.	SPS-Übersicht	= PCD2 Module		Blatt 10
			Bearb.	KAF					+ PCD2.E610		
			Gepr								
Änderung	Datum	Name	Urspr		Ersatz von	Ersetzt durch				Blatt 522	

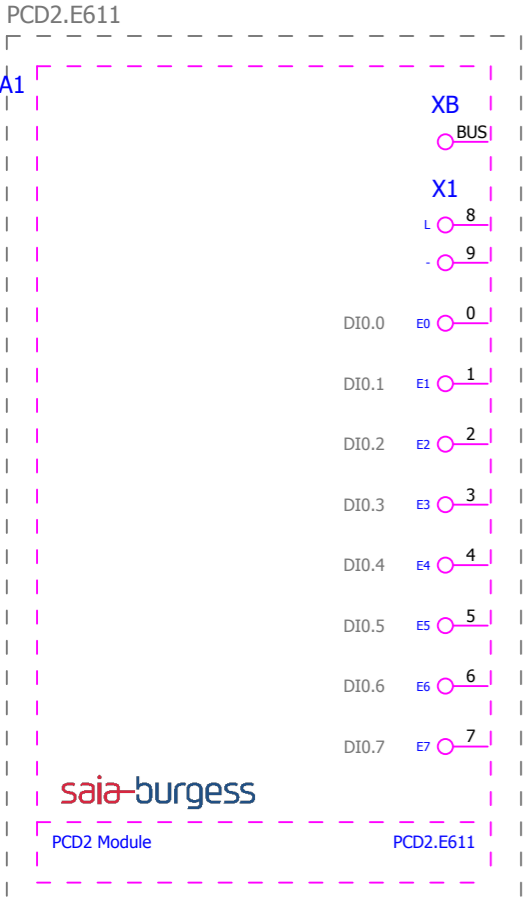

Saia-Burgess\PCD2 Module\PCD2.E611.ema
 Overview
 Variant A
 2012-10-26 / 2.1.4

bus connector

Reserve

Reserve

Reserve

Reserve

Reserve

Reserve

Reserve

Reserve

			Datum	26.10.2012	EPLAN Software & Service Saia-Burgess Makroprojekt	Saia-Burgess Controls Ltd. Control Systems and Components	Saia-Burgess Controls Ltd.	SPS-Übersicht	= PCD2 Module		Blatt 10
			Bearb.	KAF					+ PCD2.E611		
			Gepr								
Änderung	Datum	Name	Urspr		Ersatz von	Ersetzt durch				Blatt 522	

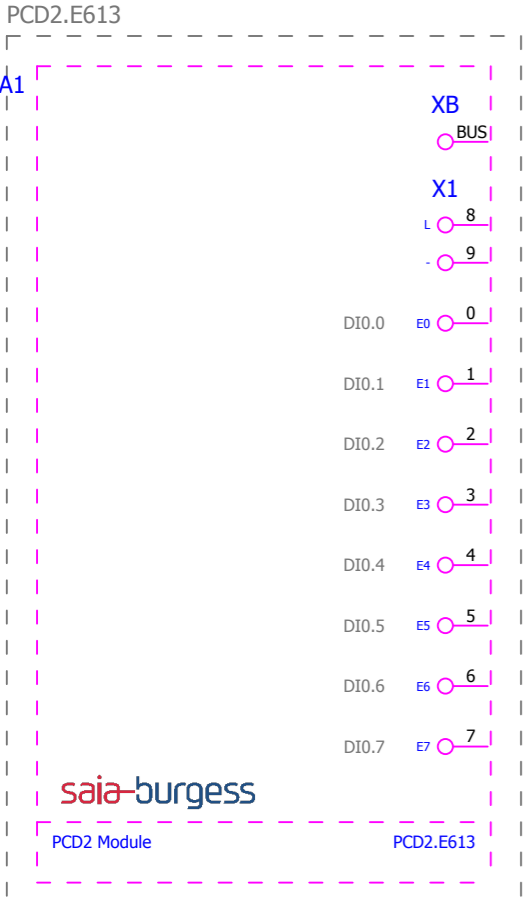

- bus connector
- Reserve
- Reserve
- Reserve
- Reserve
- Reserve
- Reserve
- Reserve
- Reserve

Saia-Burgess\PCD2 Module\PCD2.E613.ema
 Overview
 Variant A
 2012-10-26 / 2.1.4

			Datum	26.10.2012	EPLAN Software & Service Saia-Burgess Makroprojekt	Saia-Burgess Controls Ltd. Control Systems and Components	Saia-Burgess Controls Ltd.	SPS-Übersicht	= PCD2 Module		Blatt 10
			Bearb.	KAF					+ PCD2.E613		
			Gepr								
Änderung	Datum	Name	Urspr		Ersatz von	Ersetzt durch					

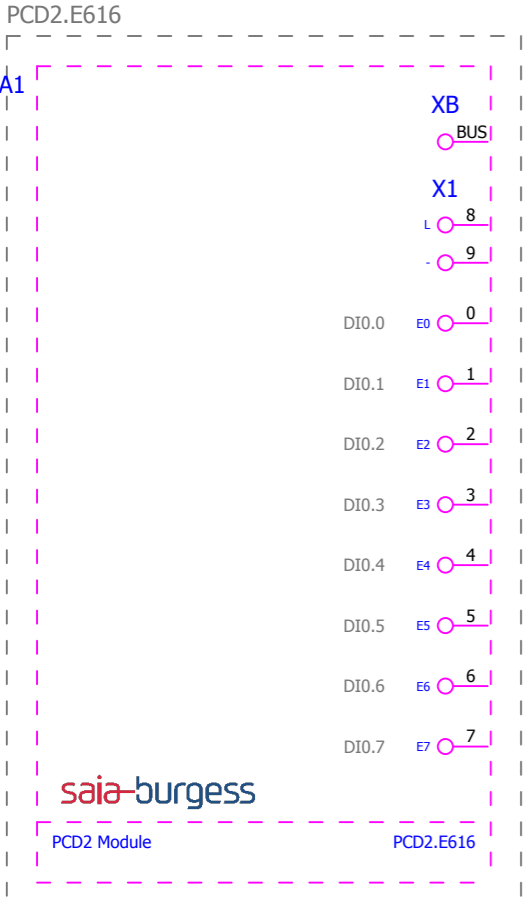

Saia-Burgess\PCD2 Module\PCD2.E616.ema
 Overview
 Variant A
 2012-10-26 / 2.1.4

bus connector

Reserve

Reserve

Reserve

Reserve

Reserve

Reserve

Reserve

Reserve

Reserve

			Datum	26.10.2012	EPLAN Software & Service Saia-Burgess Makroprojekt	Saia-Burgess Controls Ltd. Control Systems and Components	Saia-Burgess Controls Ltd.	SPS-Übersicht	= PCD2 Module		Blatt 10
			Bearb.	KAF					+ PCD2.E616		
			Gepr								
Änderung	Datum	Name	Urspr		Ersatz von	Ersetzt durch				Blatt 522	

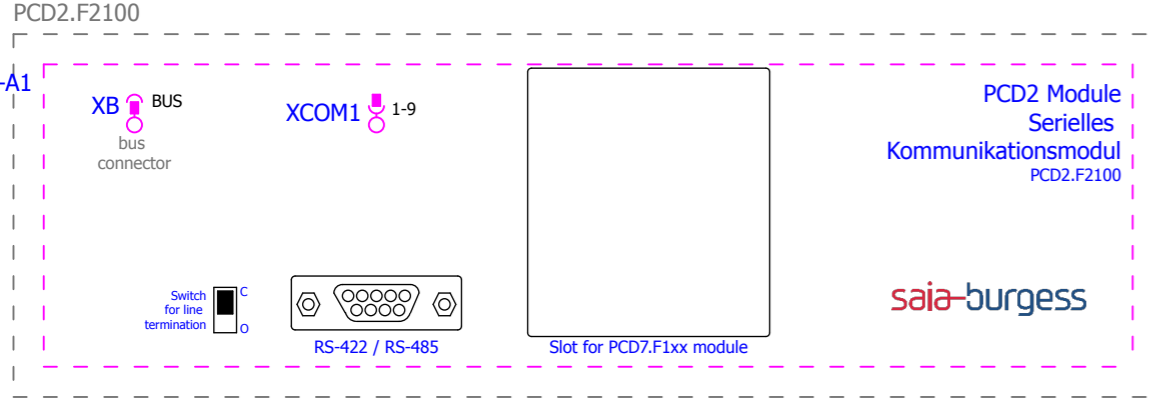

Saia-Burgess\PCD2 Module\PCD2.F2100.ema
 Multi-line
 Variant A
 2012-10-26 / 2.1.4

			Datum	26.10.2012	EPLAN Software & Service Saia-Burgess Makroprojekt	Control Systems and Components	Saia-Burgess Controls Ltd.		Allpolig		= PCD2 Module	
			Bearb.	KAF							+ PCD2.F2100	
			Gepr									
Änderung	Datum	Name	Urspr		Ersatz von	Ersetzt durch					Blatt	1
											Blatt	522

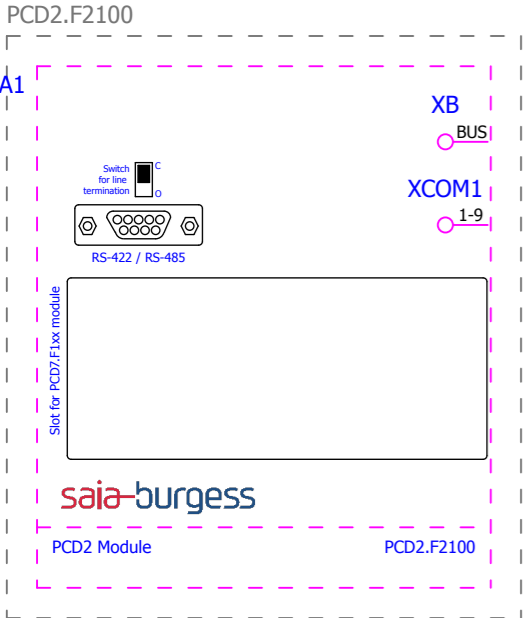

bus connector

Saia-Burgess\PCD2 Module\PCD2.F2100.ema
 Overview
 Variant A
 2012-10-26 / 2.1.4

			Datum	26.10.2012	EPLAN Software & Service Saia-Burgess Makroprojekt	Saia-Burgess Controls Ltd. Control Systems and Components	Saia-Burgess Controls Ltd.	SPS-Übersicht	= PCD2 Module		Blatt 10
		Bearb.	KAF	+ PCD2.F2100							
		Gepr									
Änderung	Datum	Name	Ürspr		Ersatz von	Ersetzt durch				Blatt 522	

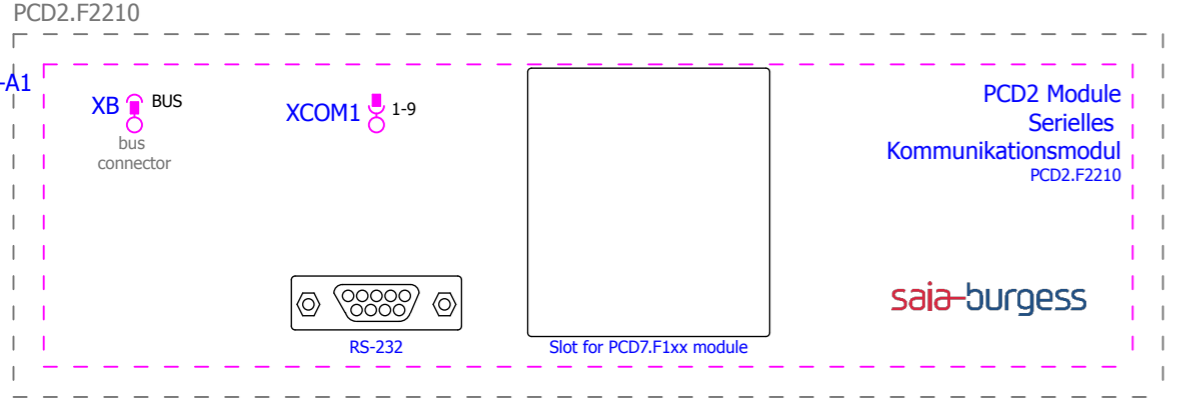

Saia-Burgess\PCD2 Module\PCD2.F2210.ema
 Multi-line
 Variant A
 2012-10-26 / 2.1.4

			Datum	26.10.2012	EPLAN Software & Service Saia-Burgess Makroprojekt	 Control Systems and Components	Saia-Burgess Controls Ltd.	Allpolig	= PCD2 Module		Blatt 1
		Bearb.	KAF	+ PCD2.F2210							
		Gepr									
Änderung	Datum	Name	Urspr		Ersatz von	Ersetzt durch				Blatt	522

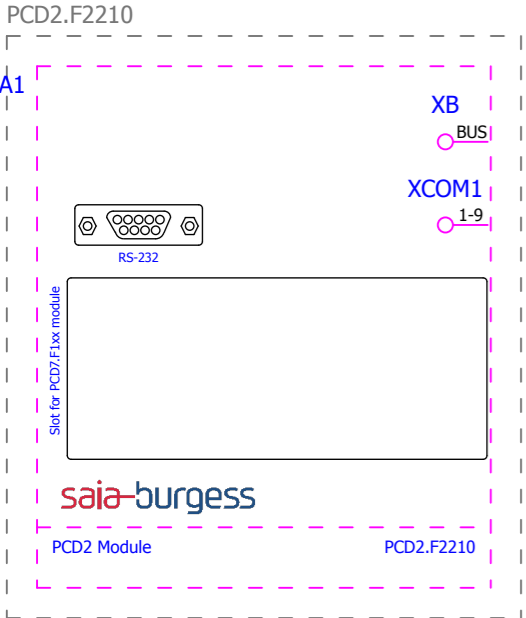

bus connector

Saia-Burgess\PCD2 Module\PCD2.F2210.ema
 Overview
 Variant A
 2012-10-26 / 2.1.4

			Datum	26.10.2012	EPLAN Software & Service Saia-Burgess Makroprojekt	Saia-Burgess Controls Ltd. Control Systems and Components	Saia-Burgess Controls Ltd.	SPS-Übersicht	= PCD2 Module		Blatt 10
		Bearb.	KAF	+ PCD2.F2210							
		Gepr									
Änderung	Datum	Name	Urspr		Ersatz von	Ersetzt durch				Blatt	522

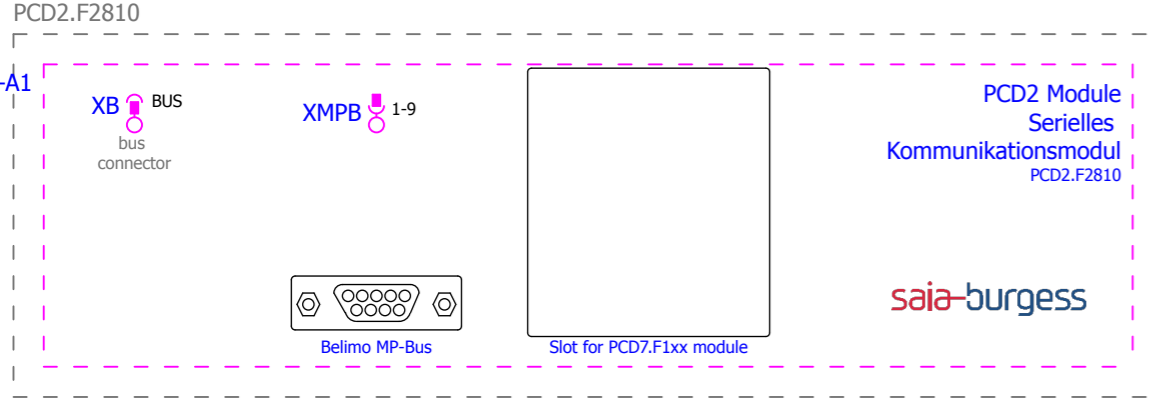

Saia-Burgess\PCD2 Module\PCD2.F2810.ema
 Multi-line
 Variant A
 2012-10-26 / 2.1.4

			Datum	26.10.2012	 EPLAN Software & Service  Saia-Burgess Makroprojekt		Saia-Burgess Controls Ltd.	Allpolig	= PCD2 Module		Blatt 1
		Bearb.	KAF	+ PCD2.F2810							
		Gepr									
Änderung	Datum	Name	Urspr		Ersatz von	Ersetzt durch				Blatt	522

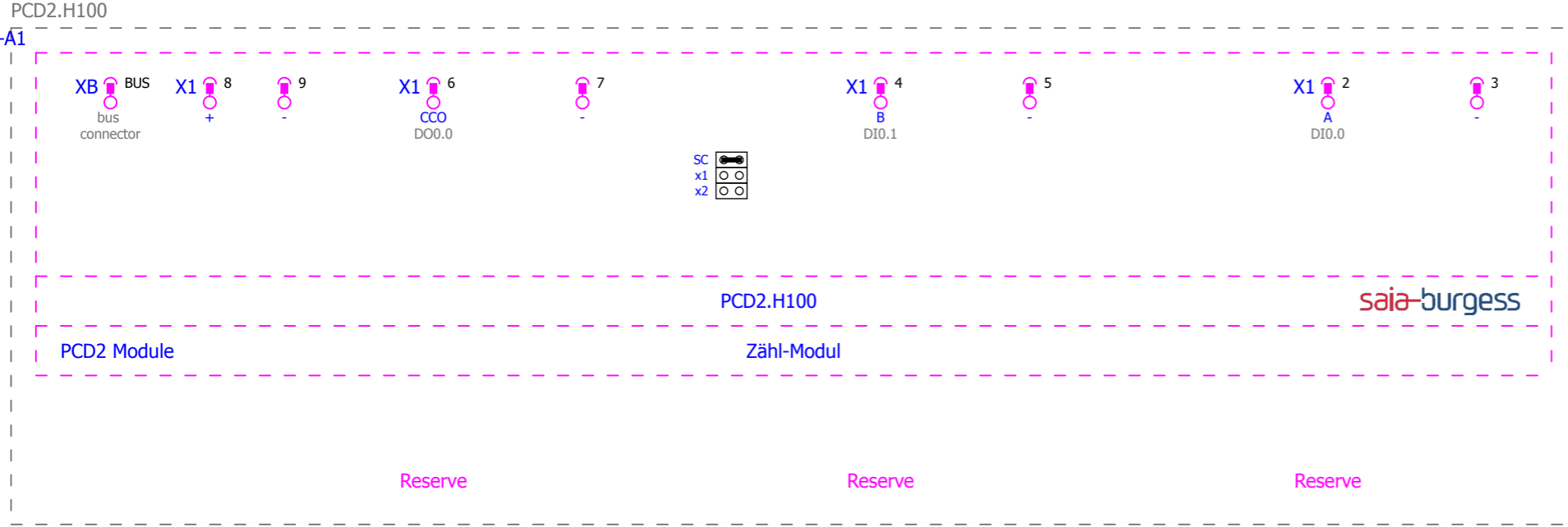

Saia-Burgess\PCD2 Module\PCD2.H100.ema
 Multi-line
 Variant A
 2012-10-26 / 2.1.4

+.F2810/10

			Datum	26.10.2012	EPLAN Software & Service Saia-Burgess Makroprojekt	Saia-Burgess Controls Ltd. Control Systems and Components	Saia-Burgess Controls Ltd.	Allpolig	= PCD2 Module	
			Bearb.	KAF					+ PCD2.H100	
			Gepr						Blatt	1
Änderung	Datum	Name	Urspr	Ersatz von	Ersetzt durch				Blatt	522

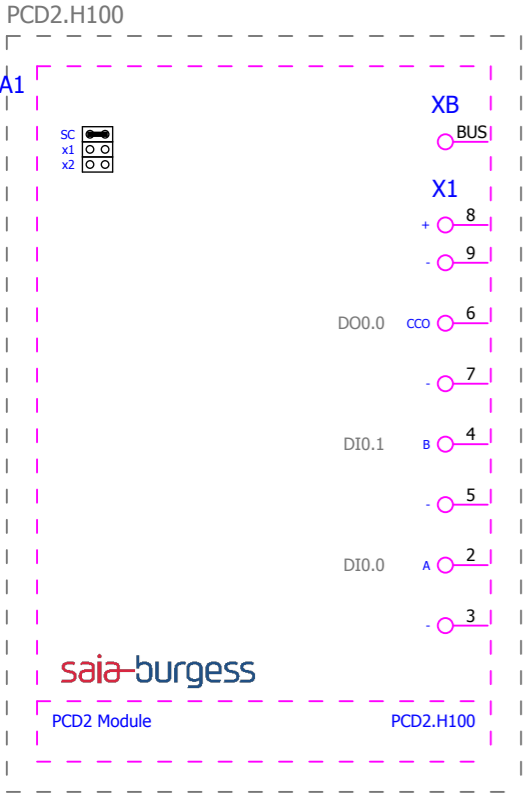

bus connector

Reserve

Reserve

Reserve

Saia-Burgess\PCD2 Module\PCD2.H100.ema
 Overview
 Variant A
 2012-10-26 / 2.1.4

			Datum	26.10.2012	EPLAN Software & Service Saia-Burgess Makroprojekt	Saia-Burgess Controls Ltd. Control Systems and Components	Saia-Burgess Controls Ltd.	SPS-Übersicht	= PCD2 Module		Blatt 10
			Bearb.	KAF					+ PCD2.H100		
			Gepr								
Änderung	Datum	Name	Urspr		Ersatz von	Ersetzt durch				Blatt	522

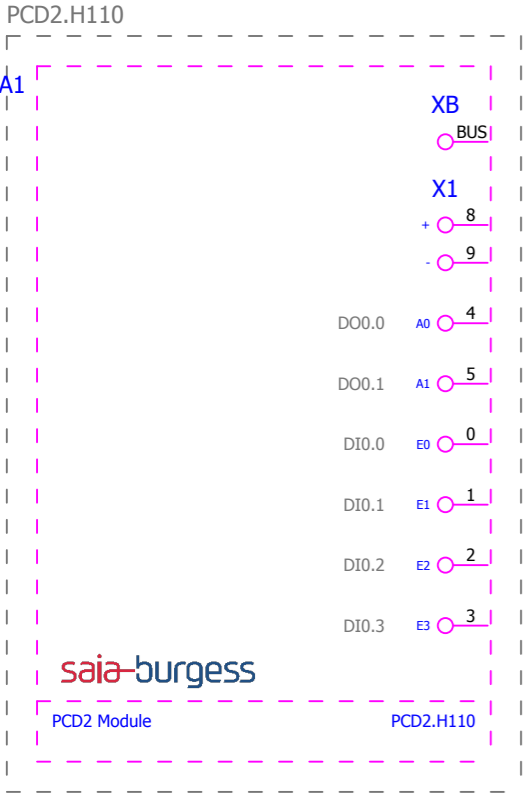

bus connector

Reserve

Reserve

Reserve

Reserve

Reserve

Reserve

Saia-Burgess\PCD2 Module\PCD2.H110.ema
 Overview
 Variant A
 2012-10-26 / 2.1.4

			Datum	26.10.2012	EPLAN Software & Service Saia-Burgess Makroprojekt	Saia-Burgess Controls Ltd. Control Systems and Components	Saia-Burgess Controls Ltd.	SPS-Übersicht	= PCD2 Module		Blatt 10
			Bearb.	KAF					+ PCD2.H110		
			Gepr								
Änderung	Datum	Name	Urspr		Ersatz von	Ersetzt durch				Blatt	522



Saia-Burgess\PCD2 Module\PCD2.H150.ema
 Multi-line
 Variant A
 2012-10-26 / 2.1.4

+.H110/10

			Datum	26.10.2012	EPLAN Software & Service Saia-Burgess Makroprojekt	 Control Systems and Components	Saia-Burgess Controls Ltd.	Allpolig	= PCD2 Module		Blatt 1
		Bearb.	KAF	+ PCD2.H150							
		Gepr									
Änderung	Datum	Name	Urspr	Ersatz von	Ersetzt durch					Blatt	522

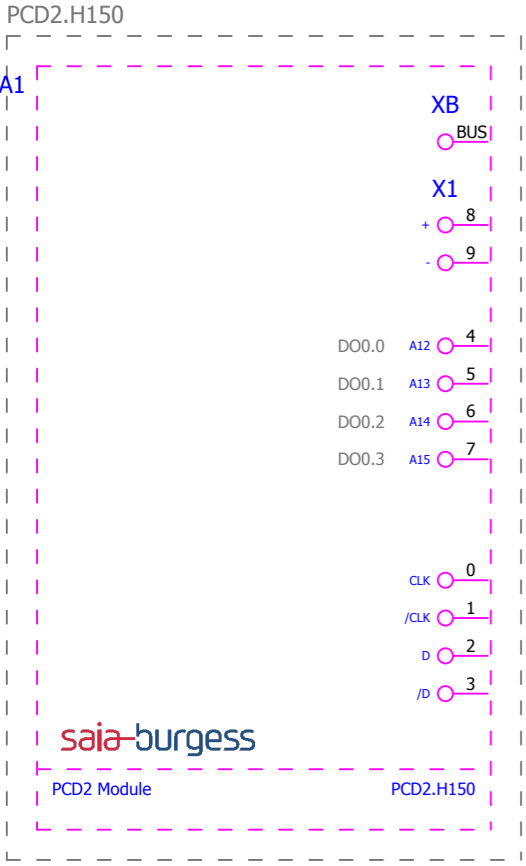

bus connector
 24V DC
 Reserve
 Reserve
 Reserve
 Reserve

Saia-Burgess\PCD2 Module\PCD2.H150.ema
 Overview
 Variant A
 2012-10-26 / 2.1.4

			Datum	26.10.2012	EPLAN Software & Service Saia-Burgess Makroprojekt	Saia-Burgess Controls Ltd. Control Systems and Components	Saia-Burgess Controls Ltd.	SPS-Übersicht	= PCD2 Module		Blatt 10
			Bearb.	KAF					+ PCD2.H150		
			Gepr								
Änderung	Datum	Name	Urspr		Ersatz von	Ersetzt durch				Blatt 522	

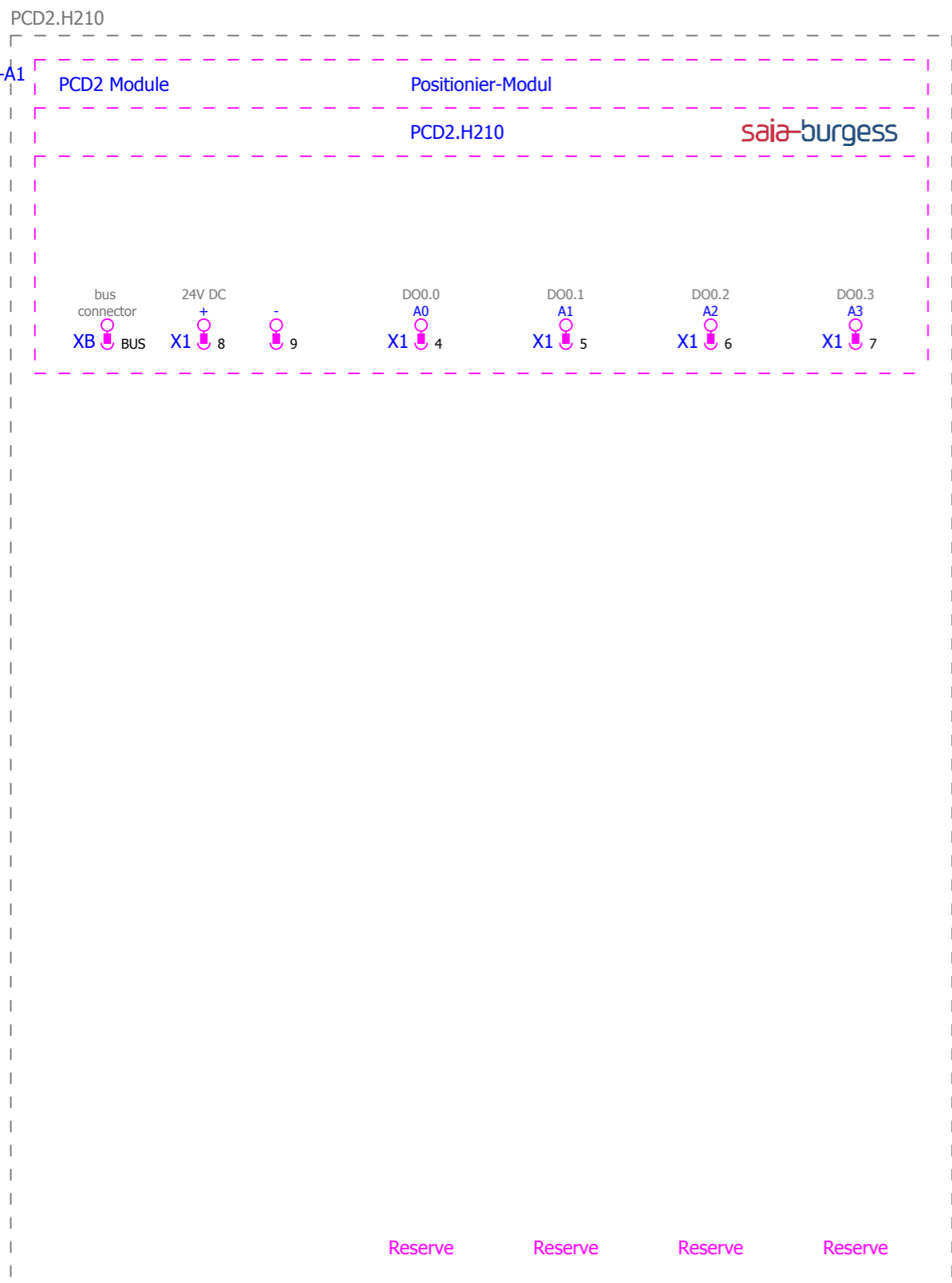

Saia-Burgess\PCD2 Module\PCD2.H210.ema
 Multi-line
 Variant A
 2012-10-26 / 2.1.4

+ .H150/10

			Datum	26.10.2012	EPLAN Software & Service Saia-Burgess Makroprojekt	Saia-Burgess Controls Ltd. <small>Control Systems and Components</small>	Allpolig	= PCD2 Module	
		Bearb.	KAF	+ PCD2.H210					
		Gepr		Blatt				1	
Änderung	Datum	Name	Urspr	Ersatz von	Ersetzt durch			Blatt	522

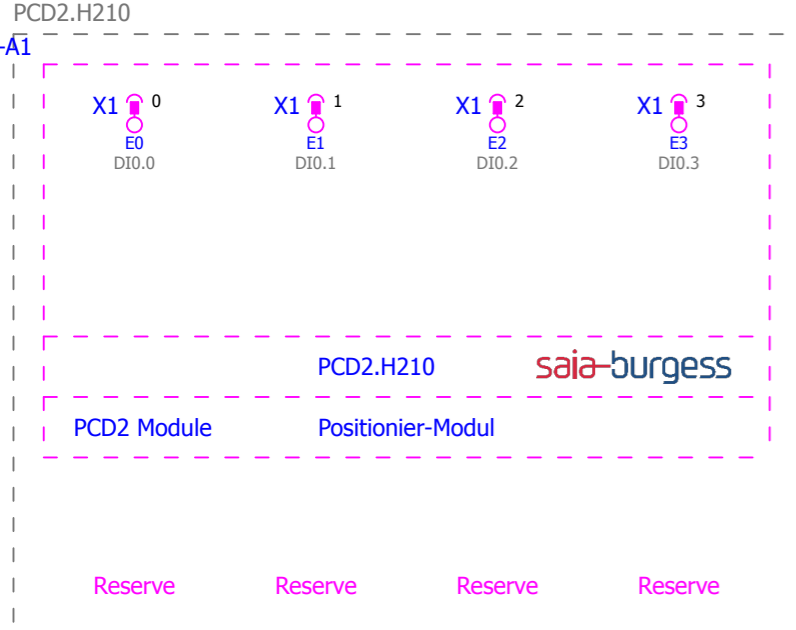

Saia-Burgess\PCD2 Module\PCD2.H210.ema
 Multi-line
 Variant B
 2012-10-26 / 2.1.4

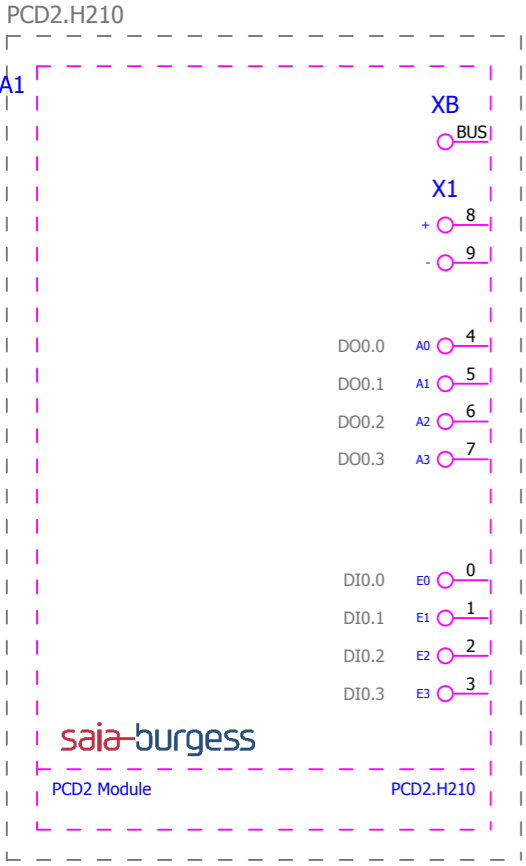

- bus connector
- 24V DC
- Reserve
- Reserve
- Reserve
- Reserve
- Reserve
- Reserve
- Reserve
- Reserve
- Reserve

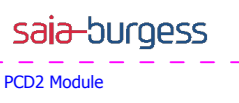

Saia-Burgess\PCD2 Module\PCD2.H210.ema
 Overview
 Variant A
 2012-10-26 / 2.1.4

			Datum	26.10.2012	EPLAN Software & Service Saia-Burgess Makroprojekt	Saia-Burgess Controls Ltd. Control Systems and Components	Saia-Burgess Controls Ltd.	SPS-Übersicht	= PCD2 Module		Blatt 10
			Bearb.	KAF					+ PCD2.H210		
			Gepr								
Änderung	Datum	Name	Urspr		Ersatz von	Ersetzt durch				Blatt	522

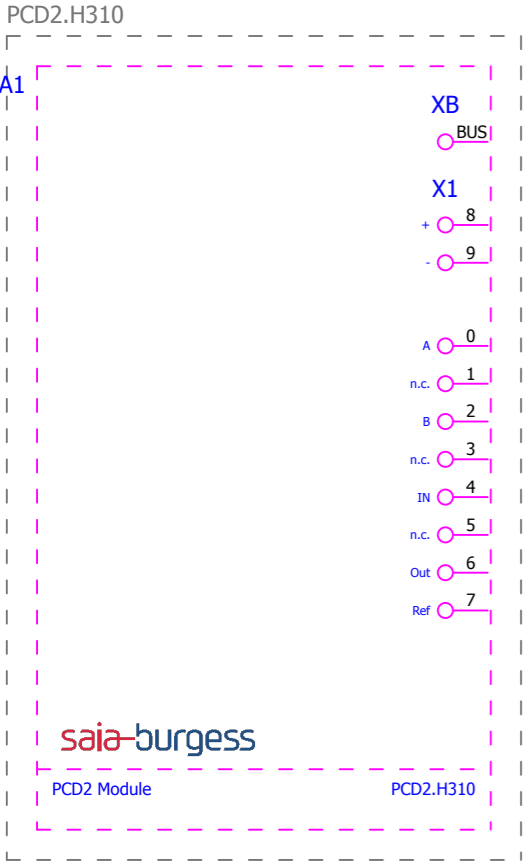

bus connector

24V DC

Saia-Burgess\PCD2 Module\PCD2.H310.ema
 Overview
 Variant A
 2012-10-26 / 2.1.4

			Datum	26.10.2012	EPLAN Software & Service Saia-Burgess Makroprojekt	Saia-Burgess Controls Ltd. Control Systems and Components	Saia-Burgess Controls Ltd.	SPS-Übersicht	= PCD2 Module		Blatt 10
		Bearb.	KAF	+ PCD2.H310							
		Gepr									
Änderung	Datum	Name	Urspr		Ersatz von	Ersetzt durch				Blatt	522

PCD2.H311

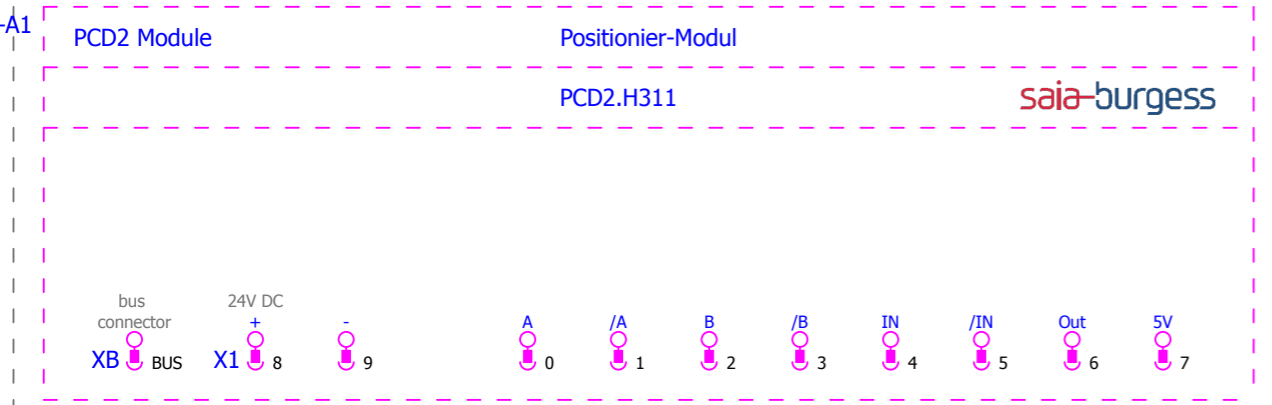

Saia-Burgess\PCD2 Module\PCD2.H311.ema
 Multi-line
 Variant A
 2012-10-26 / 2.1.4

+.H310/10

10

			Datum	26.10.2012	EPLAN Software & Service Saia-Burgess Makroprojekt	Saia-Burgess Controls Ltd. <small>Control Systems and Components</small>	Allpolig	= PCD2 Module	
		Bearb.	KAF	+ PCD2.H311					
		Gepr						Blatt 1	
Änderung	Datum	Name	Urspr	Ersatz von	Ersetzt durch				Blatt 522

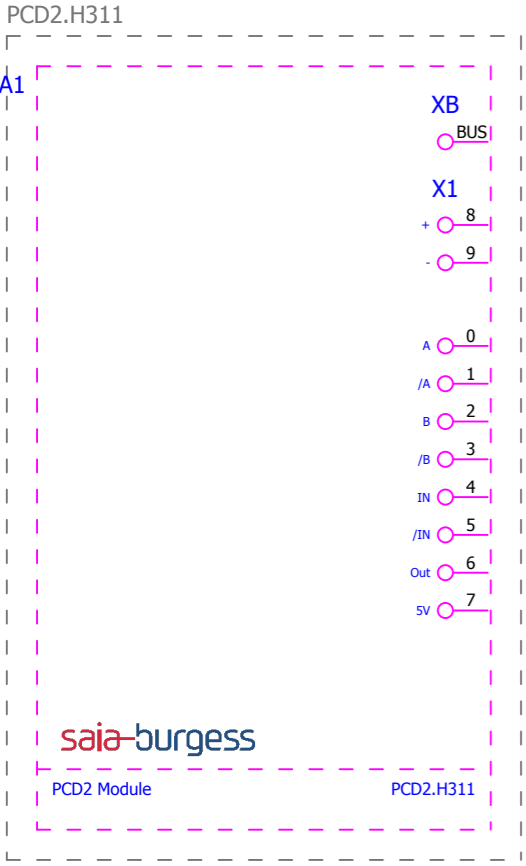

bus connector

24V DC

Saia-Burgess\PCD2 Module\PCD2.H311.ema
 Overview
 Variant A
 2012-10-26 / 2.1.4

			Datum	26.10.2012	EPLAN Software & Service Saia-Burgess Makroprojekt	Saia-Burgess Controls Ltd. Control Systems and Components	Saia-Burgess Controls Ltd.	SPS-Übersicht	= PCD2 Module		Blatt 10
		Bearb.	KAF	+ PCD2.H311							
		Gepr									
Änderung	Datum	Name	Urspr		Ersatz von	Ersetzt durch				Blatt 522	



Saia-Burgess\PCD2 Module\PCD2.H320.ema
 Multi-line
 Variant A
 2012-10-26 / 2.1.4

+.H311/10

			Datum	26.10.2012	EPLAN Software & Service Saia-Burgess Makroprojekt	 Control Systems and Components	Saia-Burgess Controls Ltd.	Allpolig		= PCD2 Module	
		Bearb.	KAF							+ PCD2.H320	
		Gepr									
Änderung	Datum	Name	Urspr		Ersatz von	Ersetzt durch					Blatt 522

PCD2.H320

-A1

PCD2 Module

Positionier-Modul

PCD2.H320

saia-burgess



Saia-Burgess\PCD2 Module\PCD2.H320.ema
 Multi-line
 Variant B
 2012-10-26 / 2.1.4

			Datum	26.10.2012	EPLAN Software & Service Saia-Burgess Makroprojekt	Saia-Burgess Controls Ltd. <small>Control Systems and Components</small>	Allpolig	= PCD2 Module		Blatt 2
			Bearb.	KAF				+ PCD2.H320		
			Gepr							
Änderung	Datum	Name	Urspr		Ersatz von	Ersetzt durch			Blatt 522	

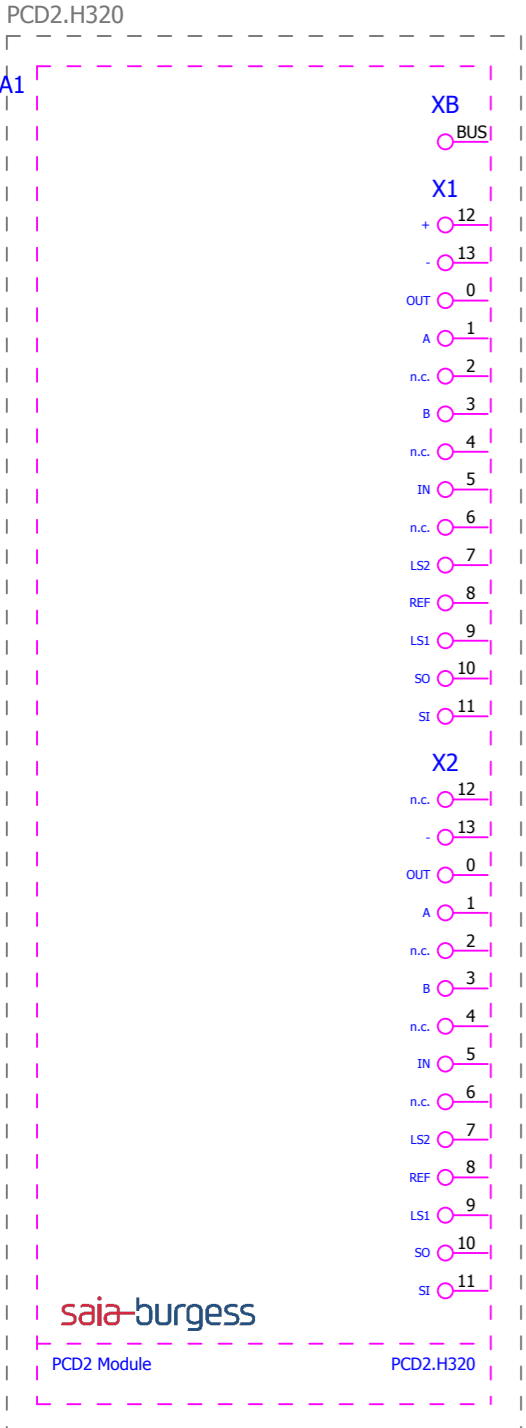

bus connector

Saia-Burgess\PCD2 Module\PCD2.H320.ema
 Overview
 Variant A
 2012-10-26 / 2.1.4

			Datum	26.10.2012	EPLAN Software & Service Saia-Burgess Makroprojekt	Saia-Burgess Controls Ltd. Control Systems and Components	Saia-Burgess Controls Ltd.	SPS-Übersicht	= PCD2 Module		Blatt 10
		Bearb.	KAF	+ PCD2.H320							
		Gepr									
Änderung	Datum	Name	Urspr	Ersatz von	Ersetzt durch					Blatt	522



Saia-Burgess\PCD2 Module\PCD2.H322.ema
 Multi-line
 Variant A
 2012-10-26 / 2.1.4

+.H320/10

			Datum	26.10.2012	EPLAN Software & Service Saia-Burgess Makroprojekt	 Control Systems and Components	Saia-Burgess Controls Ltd.	Allpolig	= PCD2 Module		Blatt 1
		Bearb.	KAF	+ PCD2.H322							
		Gepr									
Änderung	Datum	Name	Urspr		Ersatz von	Ersetzt durch				Blatt	522

PCD2.H322

-A1

PCD2 Module

Positionier-Modul

PCD2.H322

saia-burgess



Saia-Burgess\PCD2 Module\PCD2.H322.ema
 Multi-line
 Variant B
 2012-10-26 / 2.1.4

			Datum	26.10.2012	EPLAN Software & Service Saia-Burgess Makroprojekt	Saia-Burgess Controls Ltd. Control Systems and Components	Saia-Burgess Controls Ltd.	Allpolig	= PCD2 Module		Blatt 2
			Bearb.	KAF					+ PCD2.H322		
			Gepr								
Änderung	Datum	Name	Urspr		Ersatz von	Ersetzt durch			Blatt 522		

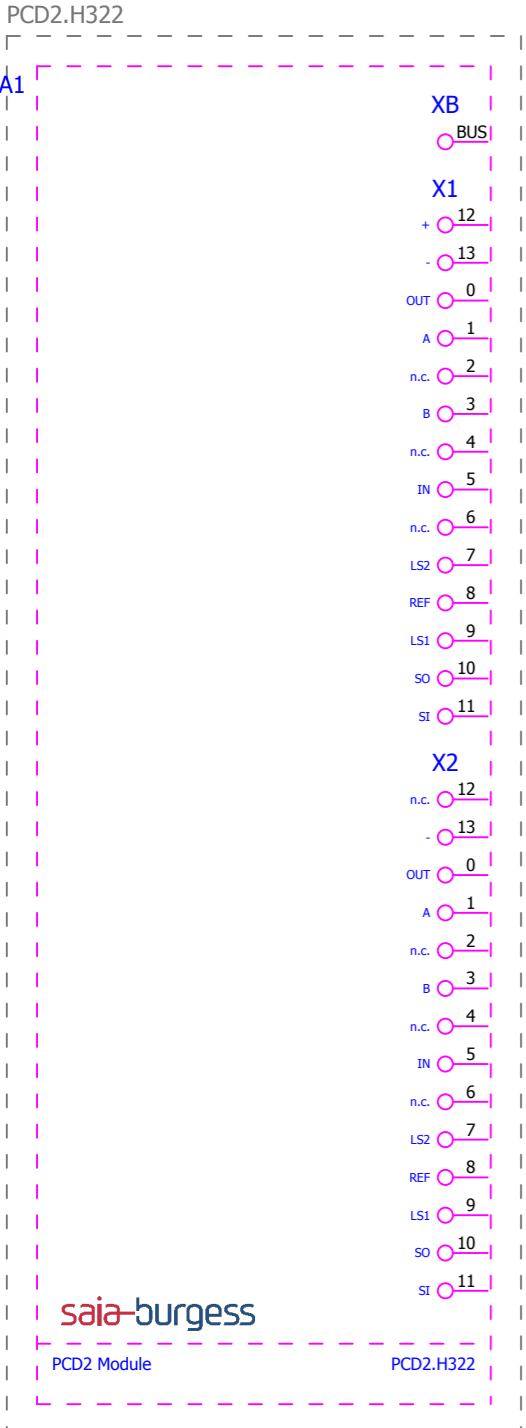

bus connector

Saia-Burgess\PCD2 Module\PCD2.H322.ema
 Overview
 Variant A
 2012-10-26 / 2.1.4

			Datum	26.10.2012	EPLAN Software & Service Saia-Burgess Makroprojekt	Saia-Burgess Controls Ltd. Control Systems and Components	Saia-Burgess Controls Ltd.	SPS-Übersicht	= PCD2 Module		Blatt 10
			Bearb.	KAF					+ PCD2.H322		
			Gepr								
Änderung	Datum	Name	Üspr		Ersatz von	Ersetzt durch			Blatt	522	



Saia-Burgess\PCD2 Module\PCD2.H325.ema
 Multi-line
 Variant A
 2012-10-26 / 2.1.4

+.H322/10

			Datum	26.10.2012	EPLAN Software & Service Saia-Burgess Makroprojekt	 Control Systems and Components	Saia-Burgess Controls Ltd.	Allpolig	= PCD2 Module		Blatt 1
		Bearb.	KAF	+ PCD2.H325							
		Gepr									
Änderung	Datum	Name	Urspr		Ersatz von	Ersetzt durch				Blatt	522

PCD2.H325

-A1

PCD2 Module

Positionier-Modul

PCD2.H325

saia-burgess



Saia-Burgess\PCD2 Module\PCD2.H325.ema
 Multi-line
 Variant B
 2012-10-26 / 2.1.4

			Datum	26.10.2012	EPLAN Software & Service Saia-Burgess Makroprojekt	Saia-Burgess Controls Ltd. Control Systems and Components	Allpolig	= PCD2 Module		Blatt 2
			Bearb.	KAF				+ PCD2.H325		
			Gepr							
Änderung	Datum	Name	Urspr		Ersatz von	Ersetzt durch			Blatt	522

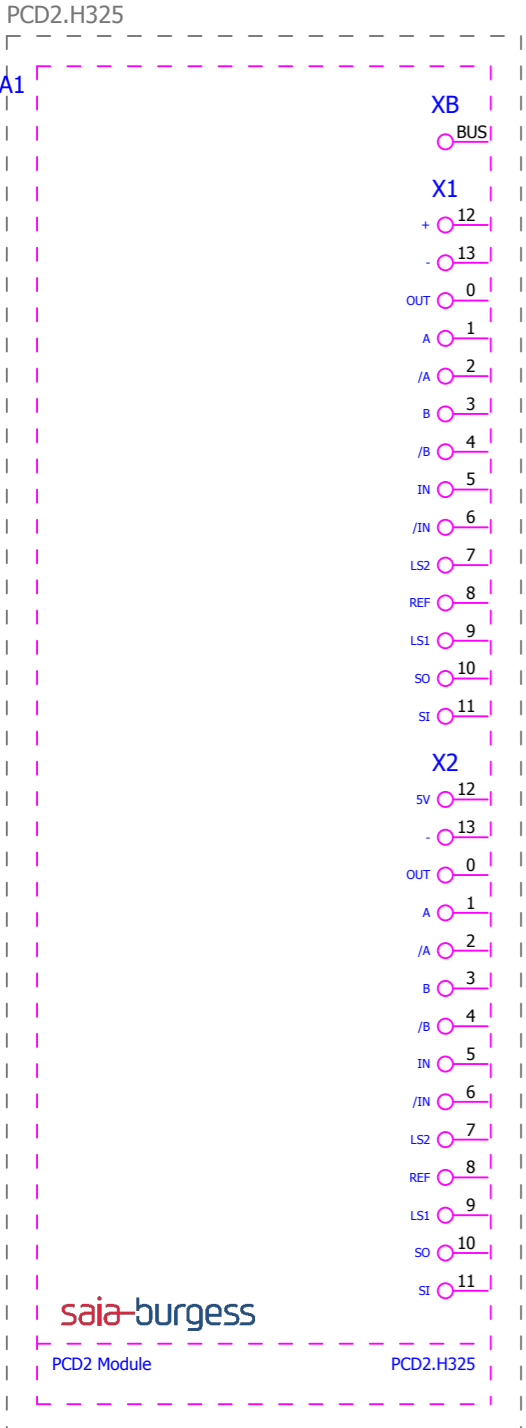

bus connector



Saia-Burgess\PCD2 Module\PCD2.H325.ema
 Overview
 Variant A
 2012-10-26 / 2.1.4

			Datum	26.10.2012	EPLAN Software & Service Saia-Burgess Makroprojekt	Saia-Burgess Controls Ltd. <small>Control Systems and Components</small>	SPS-Übersicht		= PCD2 Module			
			Bearb.	KAF					+ PCD2.H325		Blatt	10
			Gepr								Blatt	522
Änderung	Datum	Name	Üspr		Ersatz von	Ersetzt durch						



Saia-Burgess\PCD2 Module\PCD2.H327.ema
 Multi-line
 Variant A
 2012-10-26 / 2.1.4

+.H325/10

			Datum	26.10.2012	EPLAN Software & Service Saia-Burgess Makroprojekt	 Control Systems and Components	Saia-Burgess Controls Ltd.	Allpolig	= PCD2 Module	
		Bearb.	KAF	+ PCD2.H327						
		Gepr		Blatt					1	
Änderung	Datum	Name	Urspr	Ersatz von	Ersetzt durch				Blatt	522

PCD2.H327

-A1

PCD2 Module

Positionier-Modul

PCD2.H327

saia-burgess



Saia-Burgess\PCD2 Module\PCD2.H327.ema
 Multi-line
 Variant B
 2012-10-26 / 2.1.4

			Datum	26.10.2012	EPLAN Software & Service Saia-Burgess Makroprojekt	Saia-Burgess Controls Ltd. <small>Control Systems and Components</small>	Allpolig	= PCD2 Module		Blatt 2
			Bearb.	KAF				+ PCD2.H327		
			Gepr							
Änderung	Datum	Name	Urspr		Ersatz von	Ersetzt durch			Blatt	522

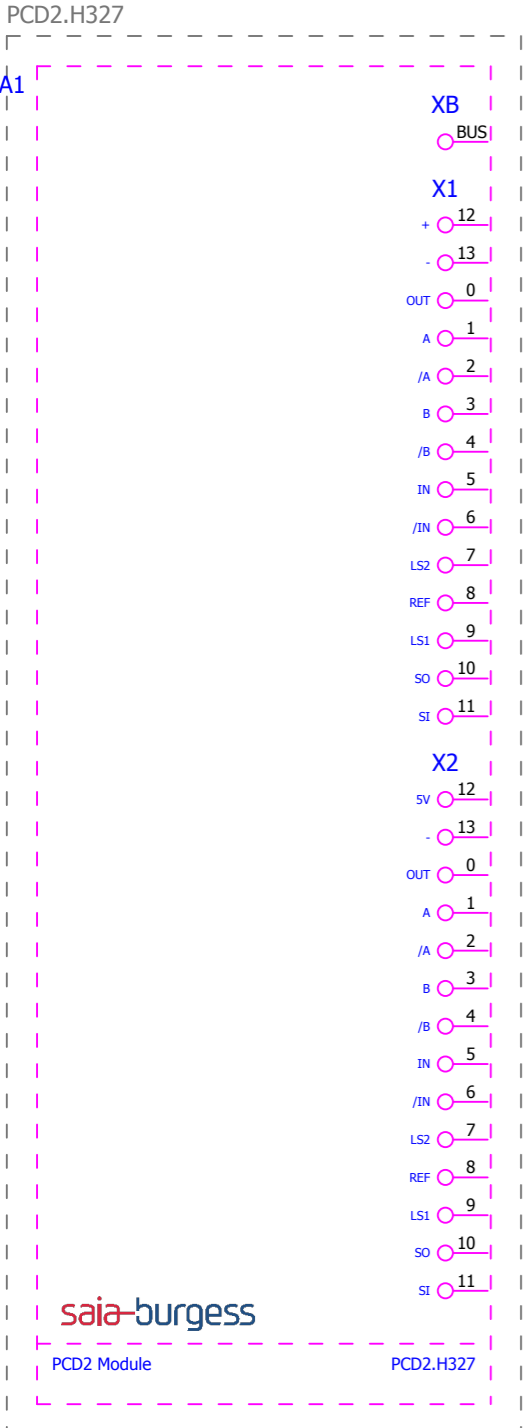

bus connector

Saia-Burgess\PCD2 Module\PCD2.H327.ema
Overview
Variant A
2012-10-26 / 2.1.4

			Datum	26.10.2012	EPLAN Software & Service Saia-Burgess Makroprojekt	Saia-Burgess Controls Ltd. Control Systems and Components	Saia-Burgess Controls Ltd.	SPS-Übersicht	= PCD2 Module		Blatt 10
			Bearb.	KAF					+ PCD2.H327		
			Gepr								
Änderung	Datum	Name	Urspr		Ersatz von	Ersetzt durch			Blatt 522		

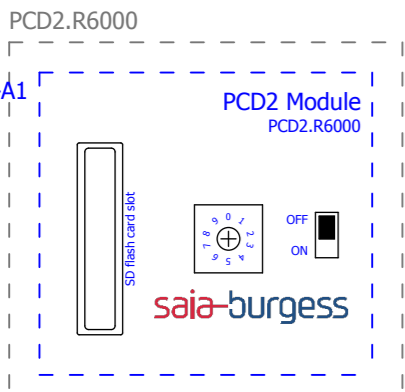

Saia-Burgess\PCD2 Module\PCD2.R6000.ema
 Multi-line
 Variant A
 2012-10-26 / 2.1.4

			Datum	26.10.2012	 EPLAN Software & Service  Saia-Burgess Makroprojekt	 Saia-Burgess Controls Ltd. <small>Control Systems and Components</small>	Saia-Burgess Controls Ltd.	Allpolig	= PCD2 Module		Blatt 1
		Bearb.	KAF	+ PCD2.R6000							
		Gepr									
Änderung	Datum	Name	Urspr		Ersatz von	Ersetzt durch				Blatt 522	

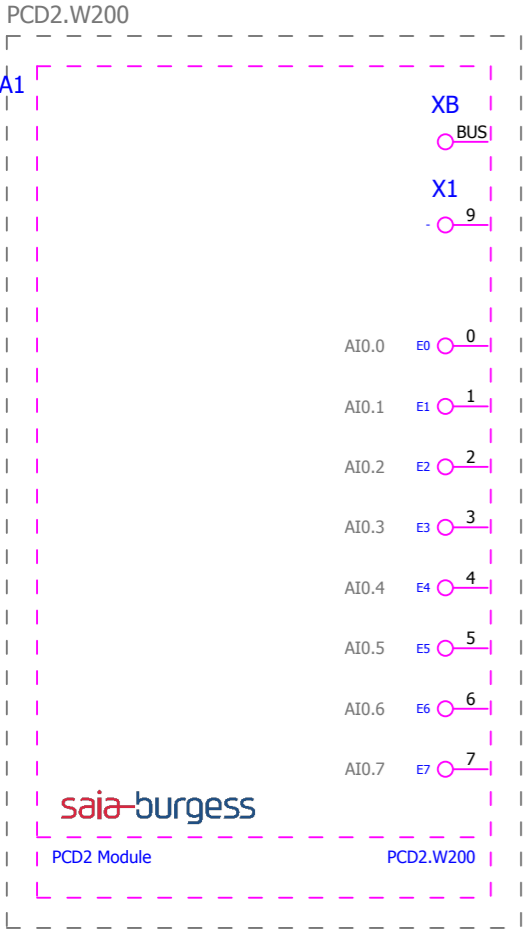

bus connector

Reserve

Reserve

Reserve

Reserve

Reserve

Reserve

Reserve

Reserve

Reserve

Saia-Burgess\PCD2 Module\PCD2.W200.ema
 Overview
 Variant A
 2012-10-26 / 2.1.4

			Datum	26.10.2012	EPLAN Software & Service Saia-Burgess Makroprojekt	Saia-Burgess Controls Ltd. Control Systems and Components	Saia-Burgess Controls Ltd.	SPS-Übersicht	= PCD2 Module		Blatt 10
			Bearb.	KAF					+ PCD2.W200		
			Gepr								
Änderung	Datum	Name	Urspr		Ersatz von	Ersetzt durch				Blatt	522

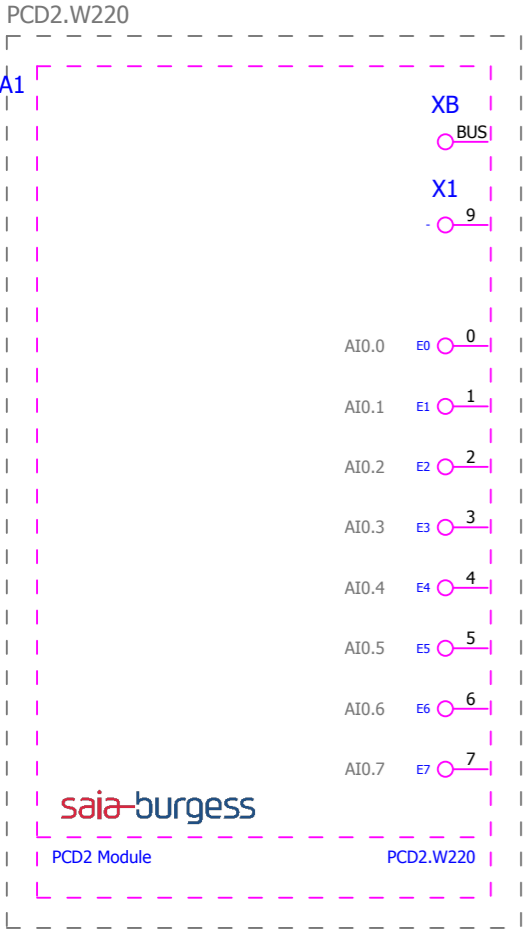

bus connector

Reserve

Reserve

Reserve

Reserve

Reserve

Reserve

Reserve

Reserve

Reserve

Saia-Burgess\PCD2 Module\PCD2.W220.ema
 Overview
 Variant A
 2012-10-26 / 2.1.4

			Datum	26.10.2012	EPLAN Software & Service Saia-Burgess Makroprojekt	Saia-Burgess Controls Ltd. Control Systems and Components	Saia-Burgess Controls Ltd.	SPS-Übersicht	= PCD2 Module		Blatt 10
			Bearb.	KAF					+ PCD2.W220		
			Gepr								
Änderung	Datum	Name	Urspr		Ersatz von	Ersetzt durch				Blatt	522

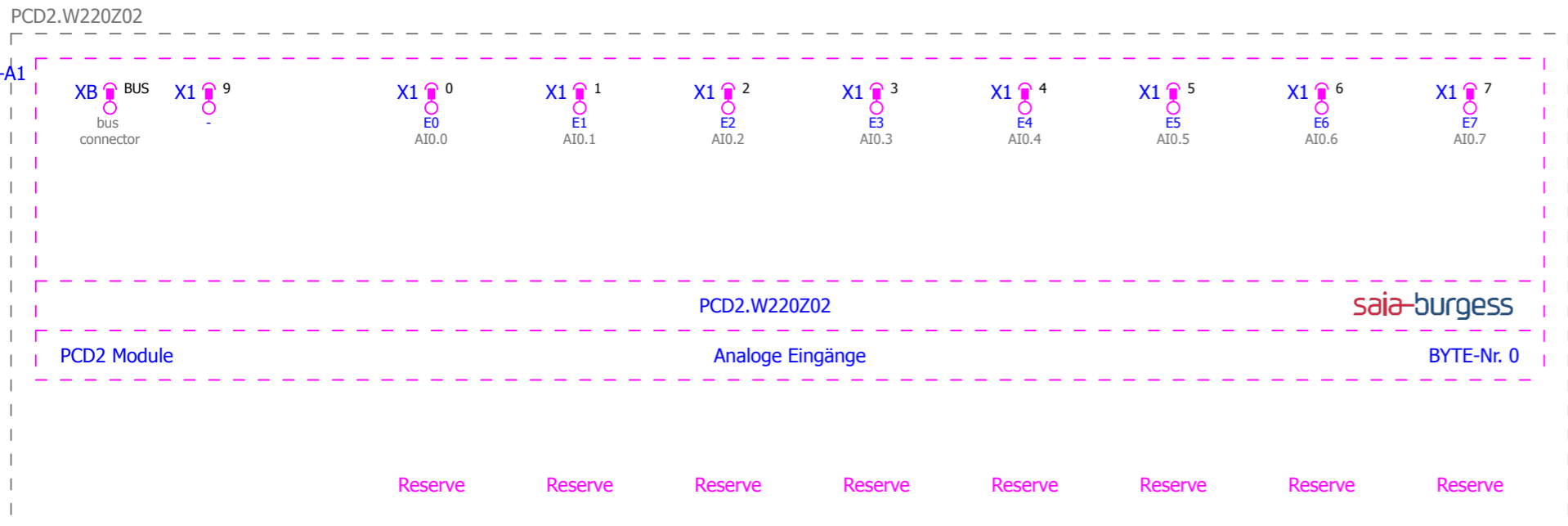

Saia-Burgess\PCD2 Module\PCD2.W220Z02.ema
 Multi-line
 Variant A
 2012-10-26 / 2.1.4

+ .W220/10

10

			Datum	26.10.2012	EPLAN Software & Service Saia-Burgess Makroprojekt	 Control Systems and Components	Saia-Burgess Controls Ltd.	Allpolig	= PCD2 Module		Blatt 1
		Bearb.	KAF	+ PCD2.W220Z02							
		Gepr								Blatt 522	
Änderung	Datum	Name	Urspr	Ersatz von	Ersetzt durch						

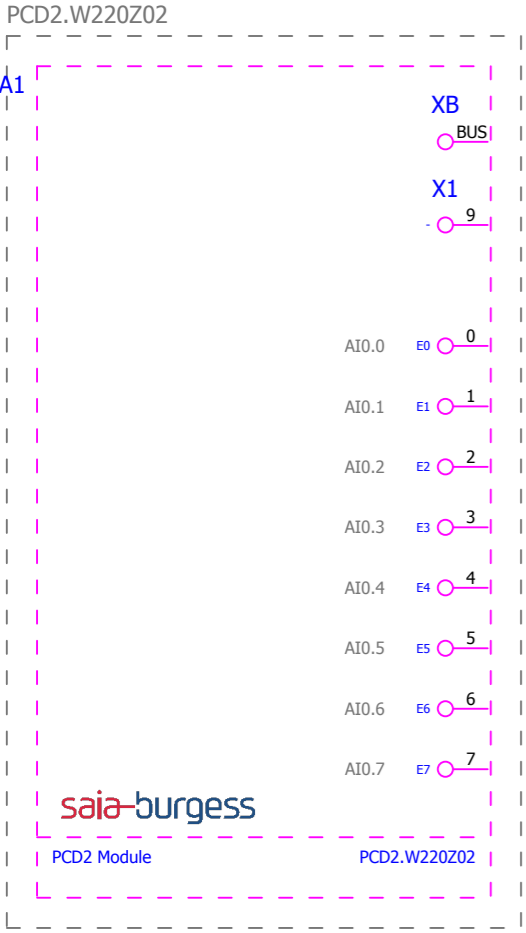

Saia-Burgess\PCD2 Module\PCD2.W220Z02.ema
 Overview
 Variant A
 2012-10-26 / 2.1.4

bus connector

Reserve

Reserve

Reserve

Reserve

Reserve

Reserve

Reserve

Reserve

			Datum	26.10.2012	EPLAN Software & Service Saia-Burgess Makroprojekt	Saia-Burgess Controls Ltd. Control Systems and Components	Saia-Burgess Controls Ltd.	SPS-Übersicht	= PCD2 Module		Blatt 10
			Bearb.	KAF					+ PCD2.W220Z02		
			Gepr								
Änderung	Datum	Name	Urspr		Ersatz von	Ersetzt durch				Blatt	522

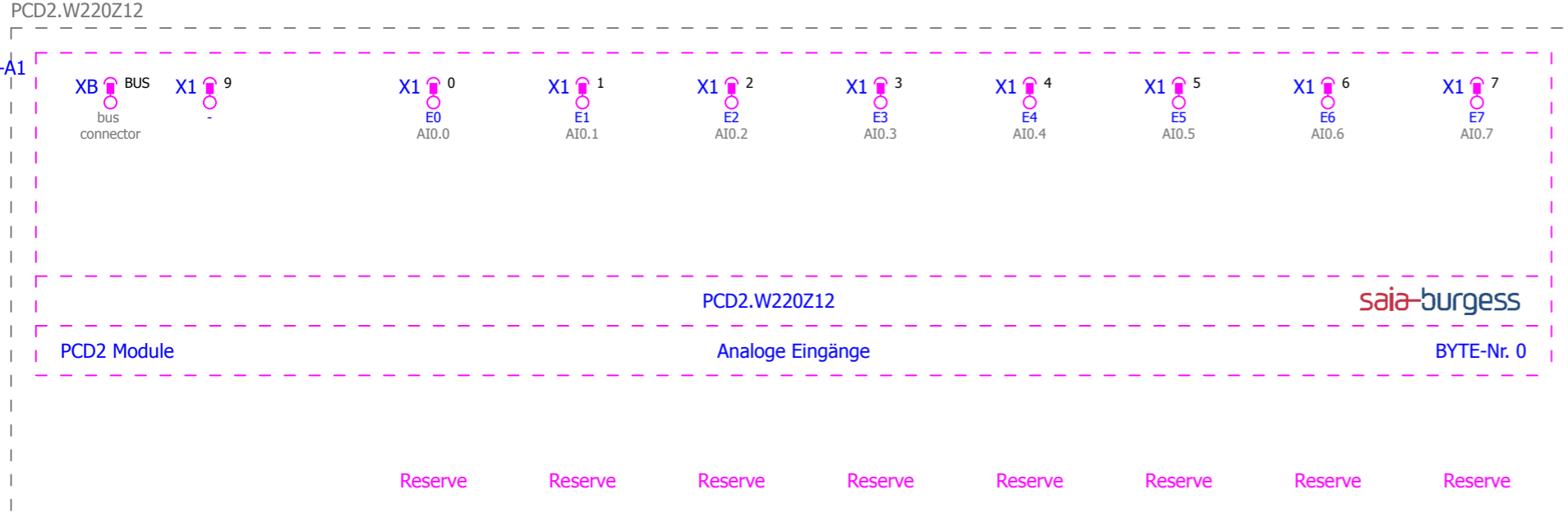

Saia-Burgess\PCD2 Module\PCD2.W220Z12.ema
 Multi-line
 Variant A
 2012-10-26 / 2.1.4
 +.W220Z02/10

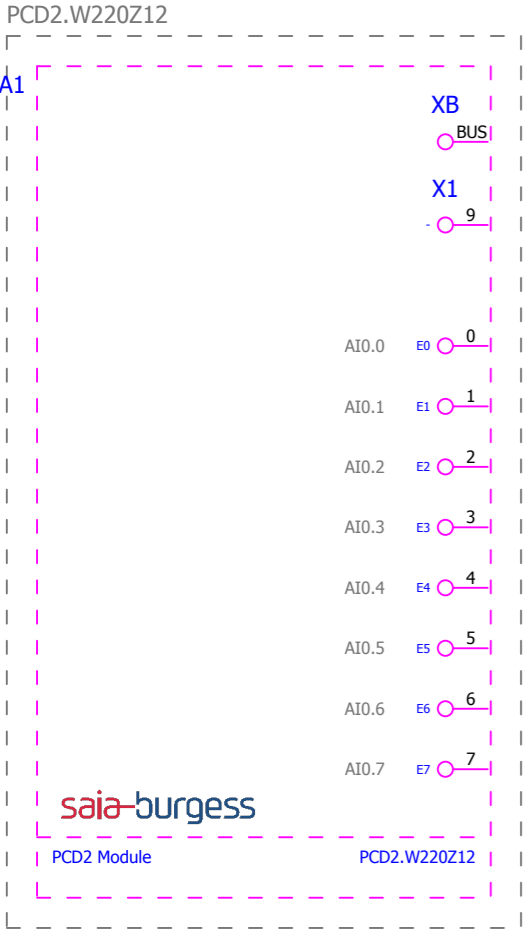

- bus connector
- Reserve
- Reserve
- Reserve
- Reserve
- Reserve
- Reserve
- Reserve

Saia-Burgess\PCD2 Module\PCD2.W220Z12.ema
 Overview
 Variant A
 2012-10-26 / 2.1.4

			Datum	26.10.2012	EPLAN Software & Service Saia-Burgess Makroprojekt	Saia-Burgess Controls Ltd. Control Systems and Components	Saia-Burgess Controls Ltd.	SPS-Übersicht	= PCD2 Module		Blatt 10
			Bearb.	KAF					+ PCD2.W220Z12		
			Gepr								
Änderung	Datum	Name	Urspr		Ersatz von	Ersetzt durch					

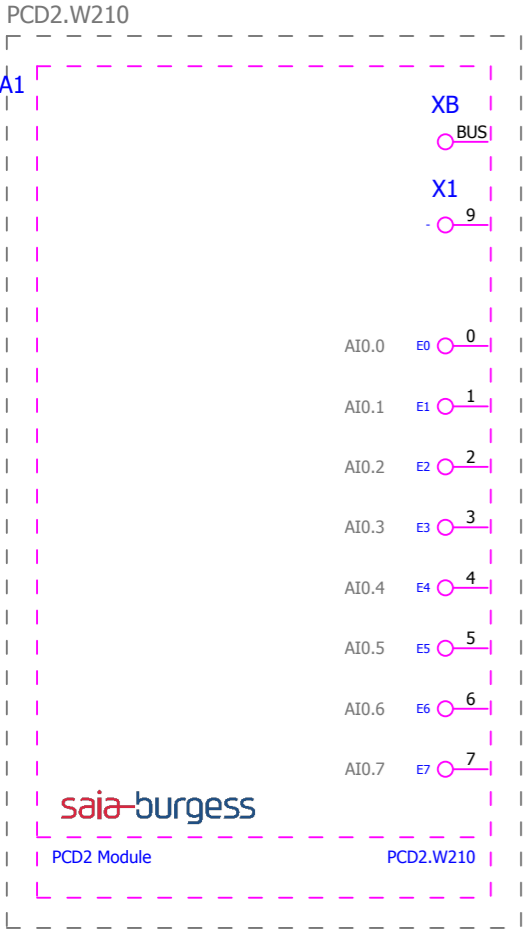

bus connector

Reserve

Reserve

Reserve

Reserve

Reserve

Reserve

Reserve

Reserve

Reserve

Saia-Burgess\PCD2 Module\PCD2.W210.ema
 Overview
 Variant A
 2012-10-26 / 2.1.4

			Datum	26.10.2012	EPLAN Software & Service Saia-Burgess Makroprojekt	Saia-Burgess Controls Ltd. Control Systems and Components	Saia-Burgess Controls Ltd.	SPS-Übersicht	= PCD2 Module		Blatt 10
			Bearb.	KAF					+ PCD2.W210		
			Gepr								
Änderung	Datum	Name	Urspr		Ersatz von	Ersetzt durch				Blatt	522

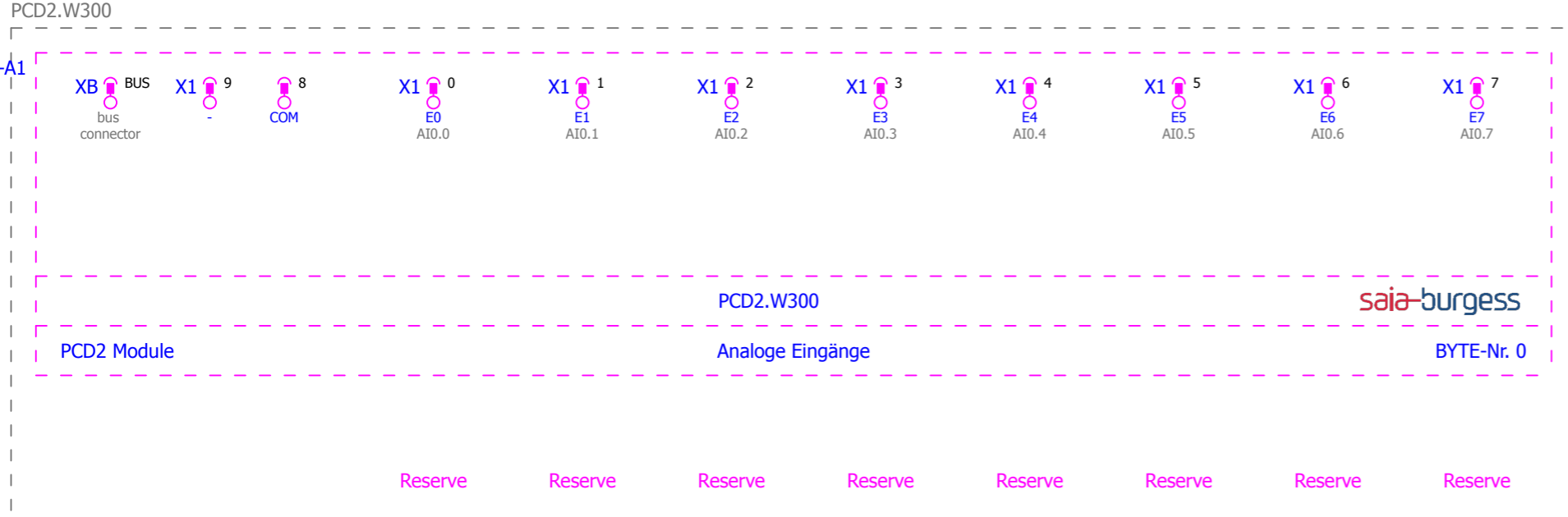

Saia-Burgess\PCD2 Module\PCD2.W300.ema
 Multi-line
 Variant A
 2012-10-26 / 2.1.4

+.W210/10

			Datum	26.10.2012	EPLAN Software & Service Saia-Burgess Makroprojekt	Saia-Burgess Controls Ltd. Control Systems and Components	Saia-Burgess Controls Ltd.	Allpolig	= PCD2 Module		Blatt 1
		Bearb.	KAF	+ PCD2.W300							
		Gepr									
Änderung	Datum	Name	Urspr	Ersatz von	Ersetzt durch					Blatt 522	

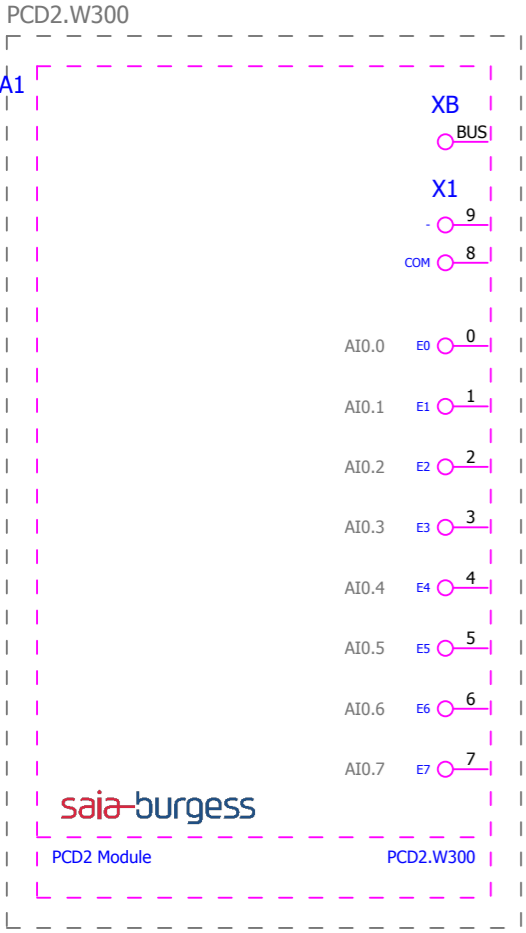

Saia-Burgess\PCD2 Module\PCD2.W300.ema
 Overview
 Variant A
 2012-10-26 / 2.1.4

bus connector

Reserve

Reserve

Reserve

Reserve

Reserve

Reserve

Reserve

Reserve

Reserve

			Datum	26.10.2012	EPLAN Software & Service Saia-Burgess Makroprojekt	Saia-Burgess Controls Ltd. Control Systems and Components	Saia-Burgess Controls Ltd.	SPS-Übersicht	= PCD2 Module		Blatt 10
			Bearb.	KAF					+ PCD2.W300		
			Gepr								
Änderung	Datum	Name	Urspr		Ersatz von	Ersetzt durch				Blatt	522

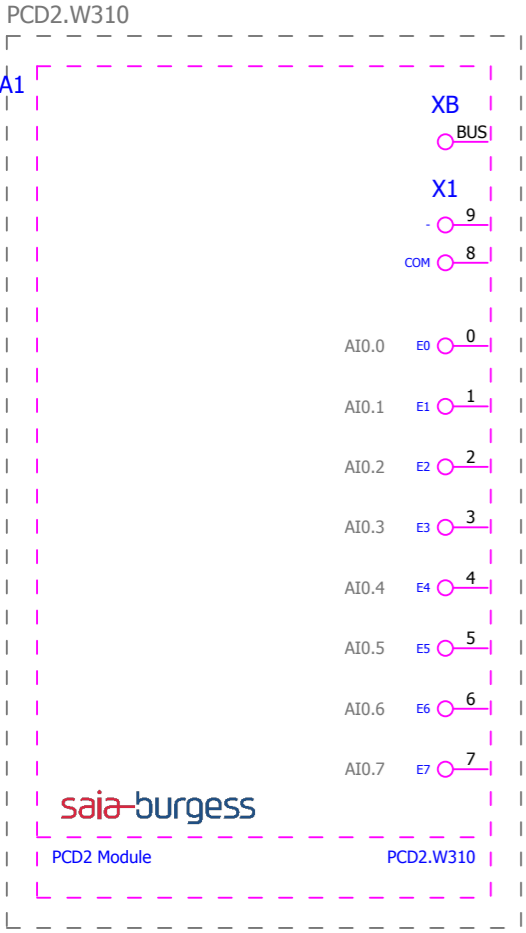

bus connector

Reserve

Reserve

Reserve

Reserve

Reserve

Reserve

Reserve

Reserve

Saia-Burgess\PCD2 Module\PCD2.W310.ema
 Overview
 Variant A
 2012-10-26 / 2.1.4

			Datum	26.10.2012	EPLAN Software & Service Saia-Burgess Makroprojekt	Saia-Burgess Controls Ltd. Control Systems and Components	Saia-Burgess Controls Ltd.	SPS-Übersicht	= PCD2 Module		Blatt 10
		Bearb.	KAF	+ PCD2.W310							
		Gepr									
Änderung	Datum	Name	Urspr		Ersatz von	Ersetzt durch				Blatt	522



bus connector

Reserve

Reserve

Reserve

Reserve

Reserve

Reserve

Reserve

Reserve

Saia-Burgess\PCD2 Module\PCD2.W340.ema
 Overview
 Variant A
 2012-10-26 / 2.1.4

			Datum	26.10.2012	EPLAN Software & Service Saia-Burgess Makroprojekt	Saia-Burgess Controls Ltd. Control Systems and Components	Saia-Burgess Controls Ltd.	SPS-Übersicht	= PCD2 Module		Blatt 10
		Bearb.	KAF	+ PCD2.W340							
		Gepr									
Änderung	Datum	Name	Urspr		Ersatz von	Ersetzt durch				Blatt	522

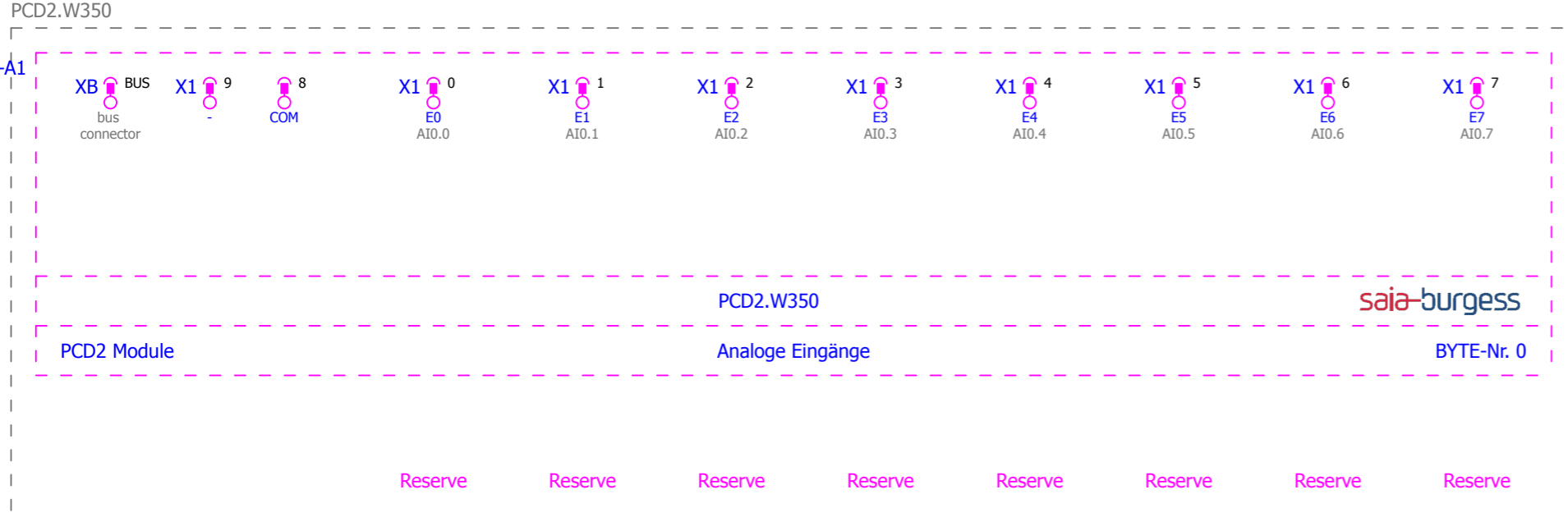

Saia-Burgess\PCD2 Module\PCD2.W350.ema
 Multi-line
 Variant A
 2012-10-26 / 2.1.4

+.W340/10

			Datum	26.10.2012	EPLAN Software & Service Saia-Burgess Makroprojekt	 Control Systems and Components	Saia-Burgess Controls Ltd.	Allpolig	= PCD2 Module	
		Bearb.	KAF	+ PCD2.W350						
		Gepr		Blatt					1	
Änderung	Datum	Name	Urspr	Ersatz von	Ersetzt durch				Blatt	522

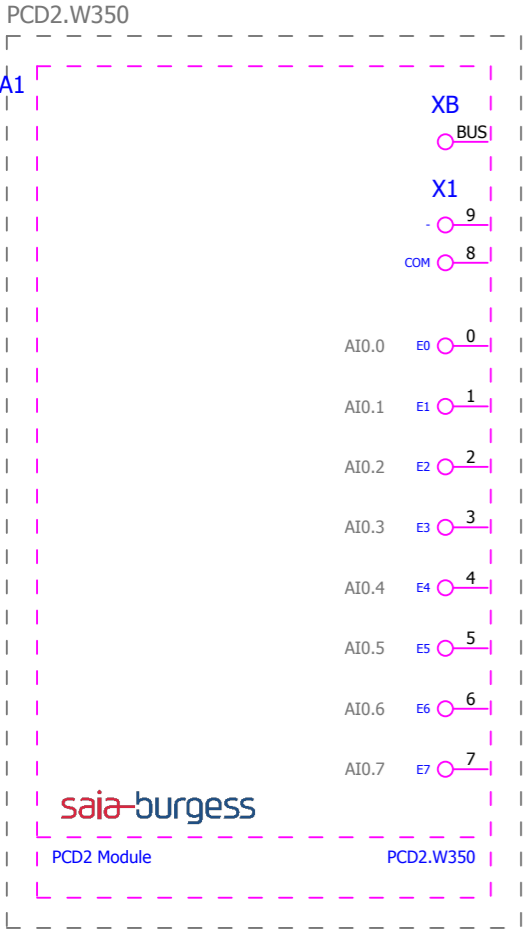

bus connector

Reserve

Reserve

Reserve

Reserve

Reserve

Reserve

Reserve

Reserve

Reserve

Saia-Burgess\PCD2 Module\PCD2.W350.ema
 Overview
 Variant A
 2012-10-26 / 2.1.4

			Datum	26.10.2012	EPLAN Software & Service Saia-Burgess Makroprojekt	Saia-Burgess Controls Ltd. Control Systems and Components	Saia-Burgess Controls Ltd.	SPS-Übersicht	= PCD2 Module		Blatt 10
			Bearb.	KAF					+ PCD2.W350		
			Gepr								
Änderung	Datum	Name	Urspr		Ersatz von	Ersetzt durch				Blatt	522

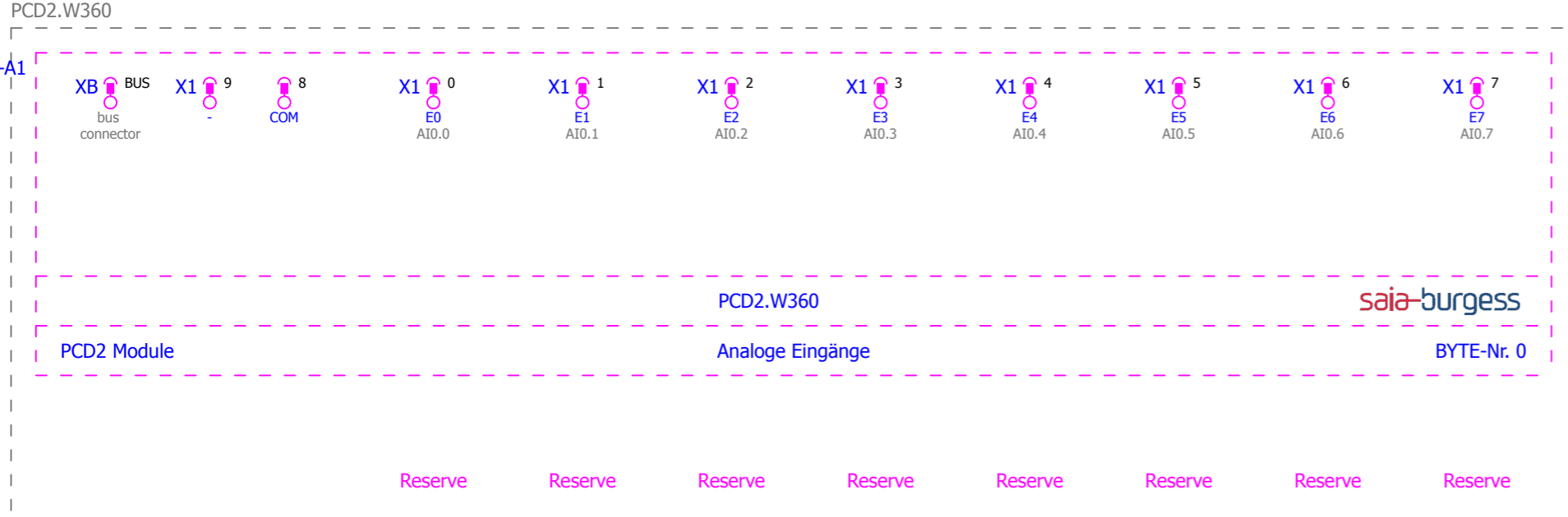

Saia-Burgess\PCD2 Module\PCD2.W360.ema
 Multi-line
 Variant A
 2012-10-26 / 2.1.4

+			W350/10		10	
Datum	26.10.2012	EPLAN Software & Service		 Saia-Burgess Controls Ltd.	Allpolig	= PCD2 Module
Bearb.	KAF	Saia-Burgess Makroprojekt				+ PCD2.W360
Gepr						Blatt 1
Änderung	Datum	Name	Urspr	Ersatz von	Ersetzt durch	Blatt 522

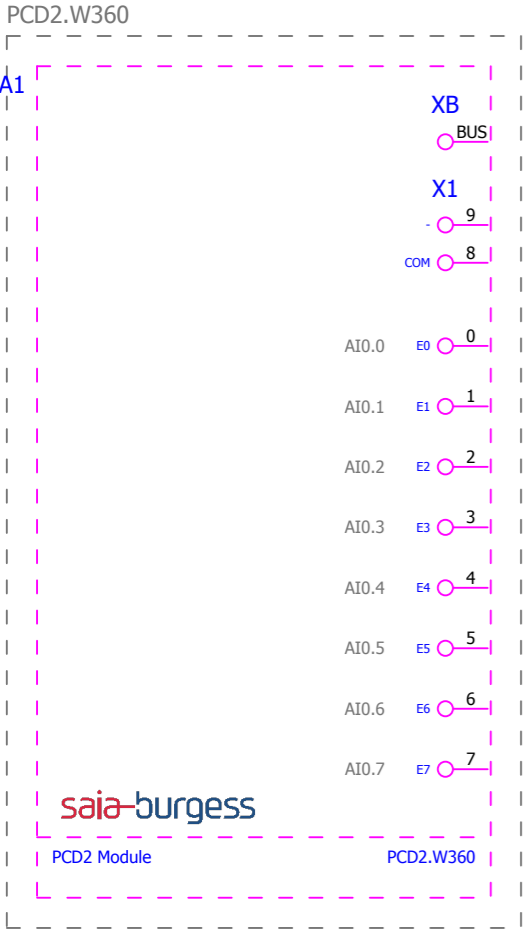

bus connector

Reserve

Reserve

Reserve

Reserve

Reserve

Reserve

Reserve

Reserve

Saia-Burgess\PCD2 Module\PCD2.W360.ema
 Overview
 Variant A
 2012-10-26 / 2.1.4

			Datum	26.10.2012	EPLAN Software & Service Saia-Burgess Makroprojekt	Saia-Burgess Controls Ltd.	SPS-Übersicht	= PCD2 Module	
		Bearb.	KAF	+ PCD2.W360					
		Gepr						Blatt	10
Änderung	Datum	Name	Urspr	Ersatz von	Ersetzt durch			Blatt	522

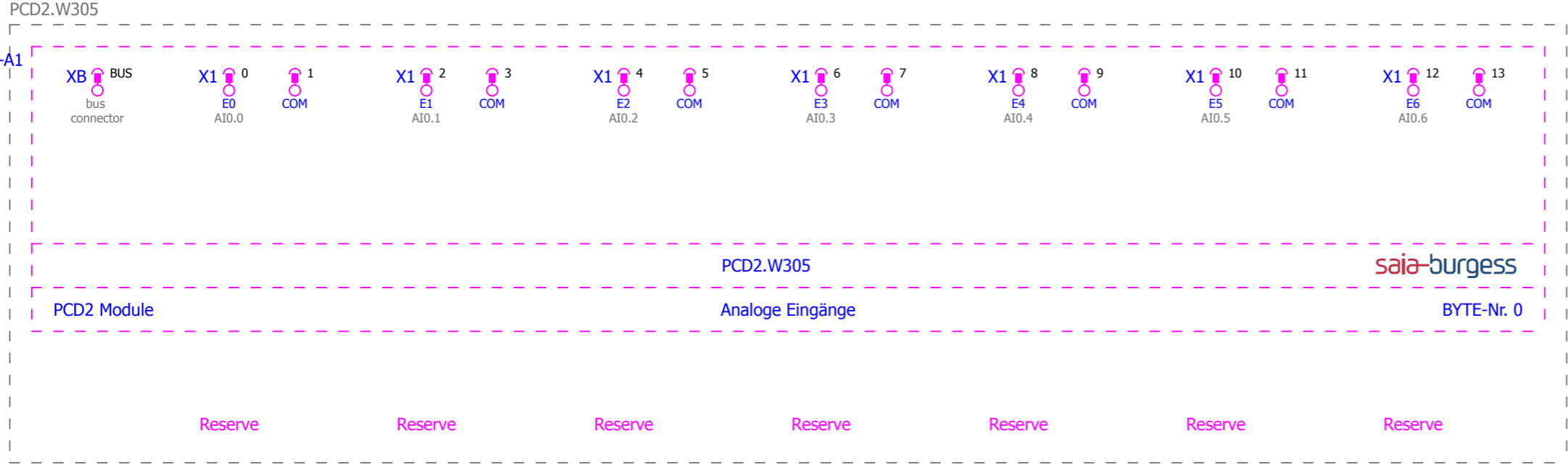

Saia-Burgess\PCD2 Module\PCD2.W305.ema
 Multi-line
 Variant A
 2012-10-26 / 2.1.4

+ .W360/10

			Datum	26.10.2012	EPLAN Software & Service Saia-Burgess Makroprojekt	 Control Systems and Components	Saia-Burgess Controls Ltd.	Allpolig			= PCD2 Module	
			Bearb.	KAF								+ PCD2.W305
			Gepr									
Änderung	Datum	Name	Urspr		Ersatz von	Ersetzt durch					Blatt 1	
											Blatt 522	



bus connector
Reserve
Reserve
Reserve
Reserve
Reserve
Reserve

Saia-Burgess\PCD2 Module\PCD2.W305.ema
Overview
Variant A
2012-10-26 / 2.1.4

			Datum	26.10.2012	EPLAN Software & Service Saia-Burgess Makroprojekt	 Control Systems and Components	Saia-Burgess Controls Ltd.	SPS-Übersicht	= PCD2 Module		Blatt 10
		Bearb.	KAF	+ PCD2.W305							
		Gepr									
Änderung	Datum	Name	Ürspr	Ersatz von	Ersetzt durch					Blatt 522	

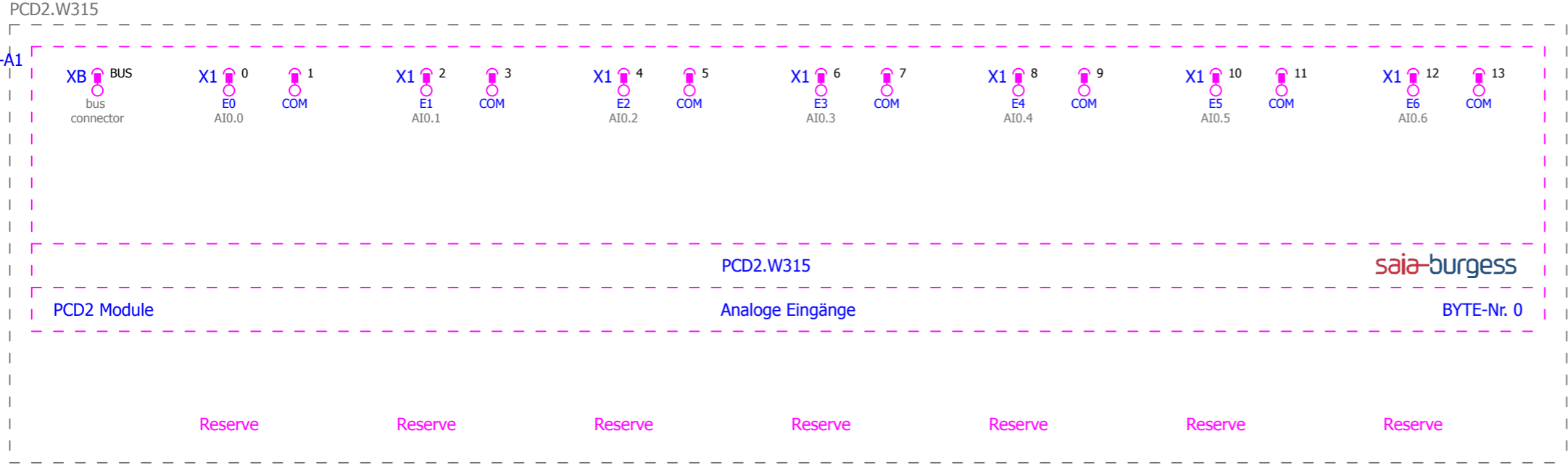

Saia-Burgess\PCD2 Module\PCD2.W315.ema
 Multi-line
 Variant A
 2012-10-26 / 2.1.4

+ .W305/10

			Datum	26.10.2012	EPLAN Software & Service Saia-Burgess Makroprojekt	Saia-Burgess Controls Ltd. Control Systems and Components	Saia-Burgess Controls Ltd.	Allpolig			= PCD2 Module		
			Bearb.	KAF									+ PCD2.W315
			Gepr										Blatt 1
Änderung	Datum	Name	Urspr		Ersatz von	Ersetzt durch					Blatt 522		



bus connector
Reserve
Reserve
Reserve
Reserve
Reserve
Reserve

Saia-Burgess\PCD2 Module\PCD2.W315.ema
Overview
Variant A
2012-10-26 / 2.1.4

			Datum	26.10.2012	EPLAN Software & Service Saia-Burgess Makroprojekt	 Control Systems and Components	Saia-Burgess Controls Ltd.	SPS-Übersicht	= PCD2 Module		Blatt 10
		Bearb.	KAF	+ PCD2.W315							
		Gepr									
Änderung	Datum	Name	Urspr	Ersatz von	Ersetzt durch					Blatt	522



bus connector
Reserve
Reserve
Reserve
Reserve
Reserve
Reserve



Saia-Burgess\PCD2 Module\PCD2.W325.ema
Overview
Variant A
2012-10-26 / 2.1.4

			Datum	26.10.2012	EPLAN Software & Service Saia-Burgess Makroprojekt	 Control Systems and Components	Saia-Burgess Controls Ltd.	SPS-Übersicht	= PCD2 Module		Blatt 10
		Bearb.	KAF	+ PCD2.W325							
		Gepr									
Änderung	Datum	Name	Ürspr		Ersatz von	Ersetzt durch				Blatt	522

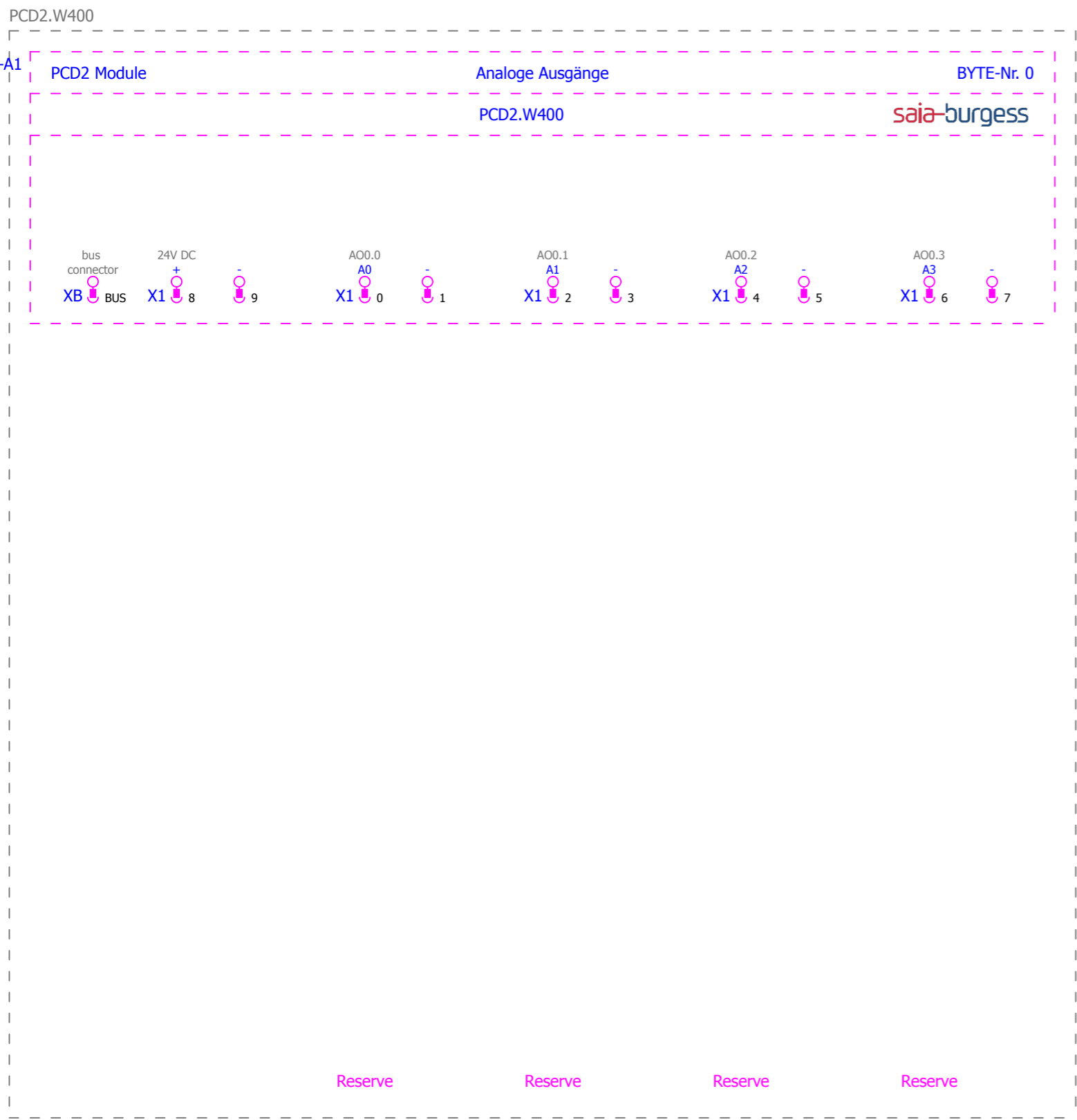

Saia-Burgess\PCD2 Module\PCD2.W400.ema
 Multi-line
 Variant A
 2012-10-26 / 2.1.4

+ .W325/10

			Datum	26.10.2012	EPLAN Software & Service Saia-Burgess Makroprojekt	 Control Systems and Components	Saia-Burgess Controls Ltd.	Allpolig		= PCD2 Module		
			Bearb.	KAF						+ PCD2.W400		
			Gepr									Blatt 1
Änderung	Datum	Name	Urspr		Ersatz von	Ersetzt durch					Blatt 522	



bus connector
 24V DC
 Reserve
 Reserve
 Reserve
 Reserve



Saia-Burgess\PCD2 Module\PCD2.W400.ema
 Overview
 Variant A
 2012-10-26 / 2.1.4

			Datum	26.10.2012	EPLAN Software & Service Saia-Burgess Makroprojekt	Saia-Burgess Controls Ltd. Control Systems and Components	Saia-Burgess Controls Ltd.	SPS-Übersicht	= PCD2 Module		Blatt 10
			Bearb.	KAF					+ PCD2.W400		
			Gepr								
Änderung	Datum	Name	Urspr		Ersatz von	Ersetzt durch				Blatt	522

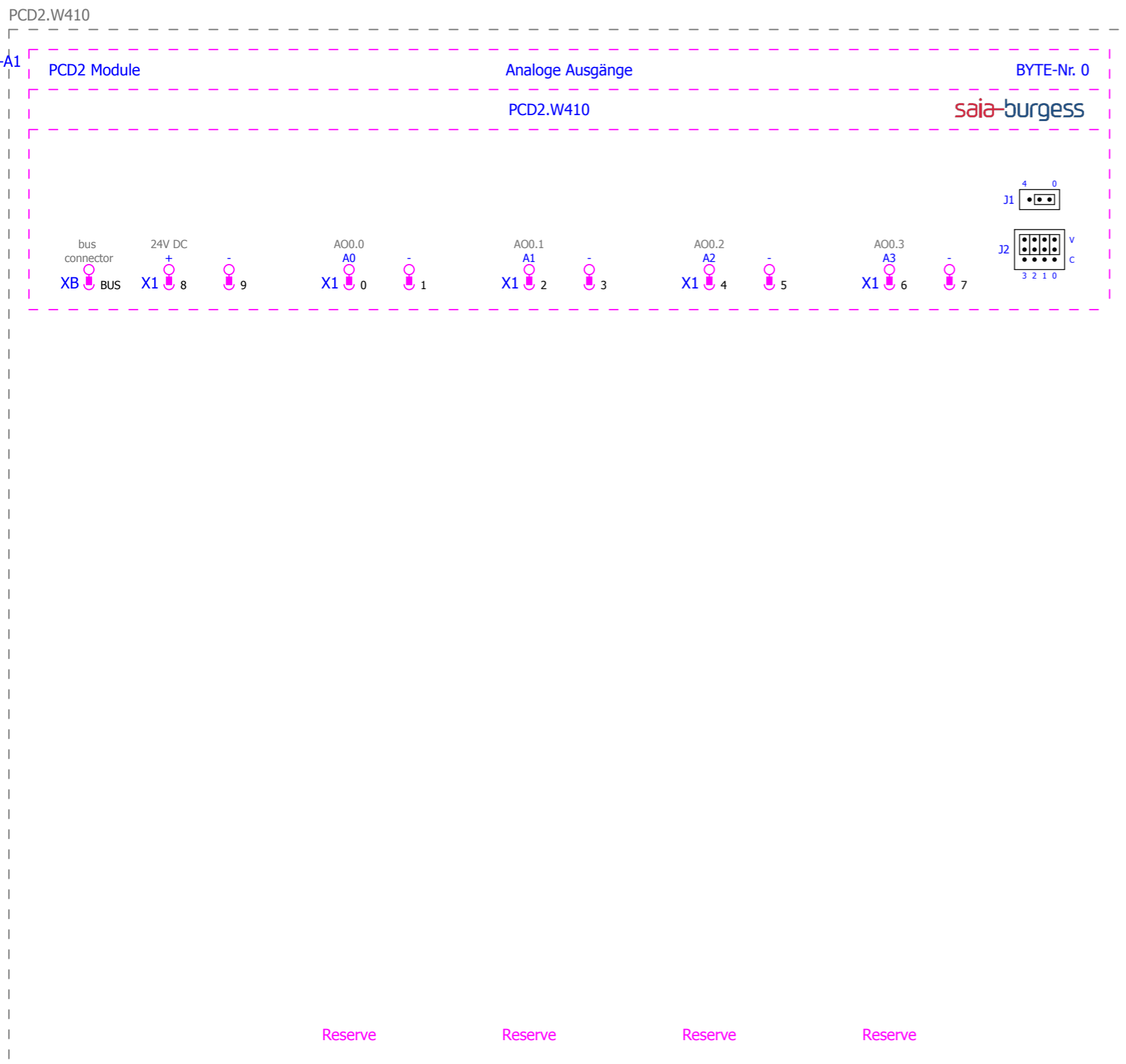

Saia-Burgess\PCD2 Module\PCD2.W410.ema
 Multi-line
 Variant A
 2012-10-26 / 2.1.4

+ .W400/10

10

			Datum	26.10.2012	EPLAN Software & Service Saia-Burgess Makroprojekt	Saia-Burgess Controls Ltd. Control Systems and Components	Saia-Burgess Controls Ltd.	Allpolig	= PCD2 Module		Blatt 1
		Bearb.	KAF	+ PCD2.W410							
		Gepr									
Änderung	Datum	Name	Urspr	Ersatz von	Ersetzt durch					Blatt 522	

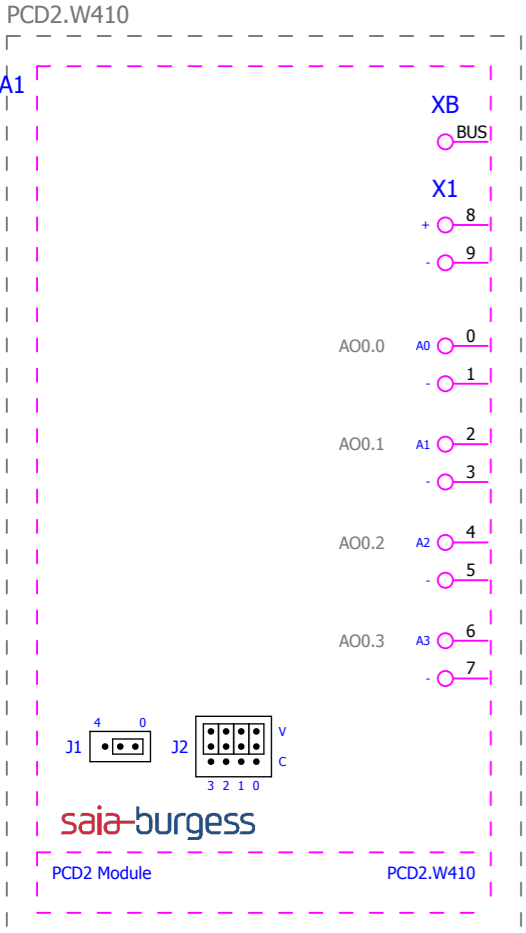

bus connector

24V DC

Reserve

Reserve

Reserve

Reserve

Saia-Burgess\PCD2 Module\PCD2.W410.ema
 Overview
 Variant A
 2012-10-26 / 2.1.4

			Datum	26.10.2012	EPLAN Software & Service Saia-Burgess Makroprojekt	Saia-Burgess Controls Ltd. Control Systems and Components	Saia-Burgess Controls Ltd.	SPS-Übersicht	= PCD2 Module		Blatt 10
			Bearb.	KAF					+ PCD2.W410		
			Gepr								
Änderung	Datum	Name	Urspr		Ersatz von	Ersetzt durch				Blatt	522



bus connector
 24V DC
 Reserve
 Reserve
 Reserve
 Reserve

Saia-Burgess\PCD2 Module\PCD2.W600.ema
 Overview
 Variant A
 2012-10-26 / 2.1.4

			Datum	26.10.2012	EPLAN Software & Service Saia-Burgess Makroprojekt	Saia-Burgess Controls Ltd. Control Systems and Components	Saia-Burgess Controls Ltd.	SPS-Übersicht	= PCD2 Module		Blatt 10
			Bearb.	KAF					+ PCD2.W600		
			Gepr								
Änderung	Datum	Name	Urspr		Ersatz von	Ersetzt durch				Blatt	522

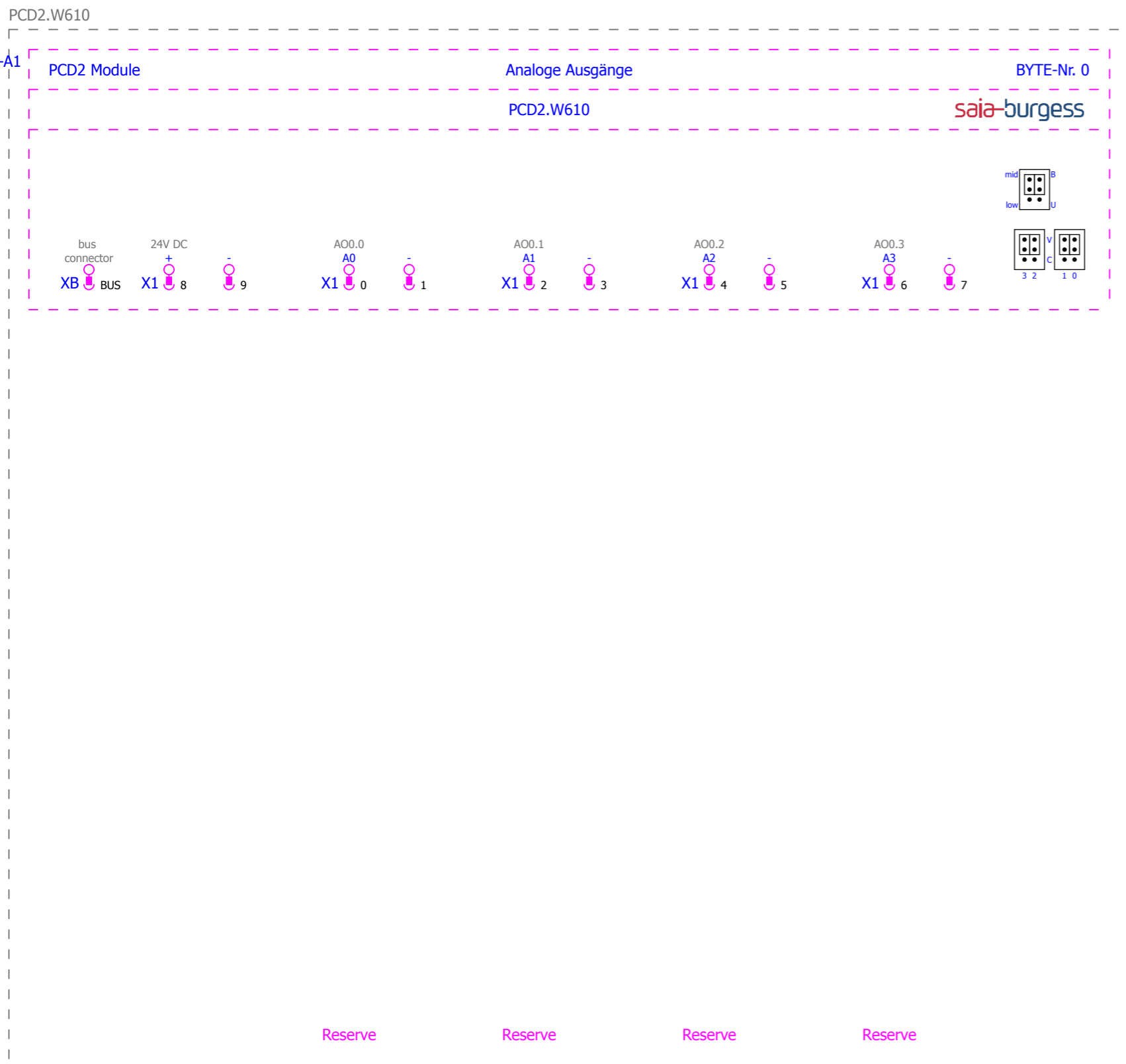

Saia-Burgess\PCD2 Module\PCD2.W610.ema
 Multi-line
 Variant A
 2012-10-26 / 2.1.4

+ .W600/10

10

			Datum	26.10.2012	EPLAN Software & Service Saia-Burgess Makroprojekt	Saia-Burgess Controls Ltd. Control Systems and Components	Saia-Burgess Controls Ltd.	Allpolig	= PCD2 Module	
		Bearb.	KAF	+ PCD2.W610						
		Gepr		Blatt					1	
Änderung	Datum	Name	Urspr	Ersatz von	Ersetzt durch				Blatt	522

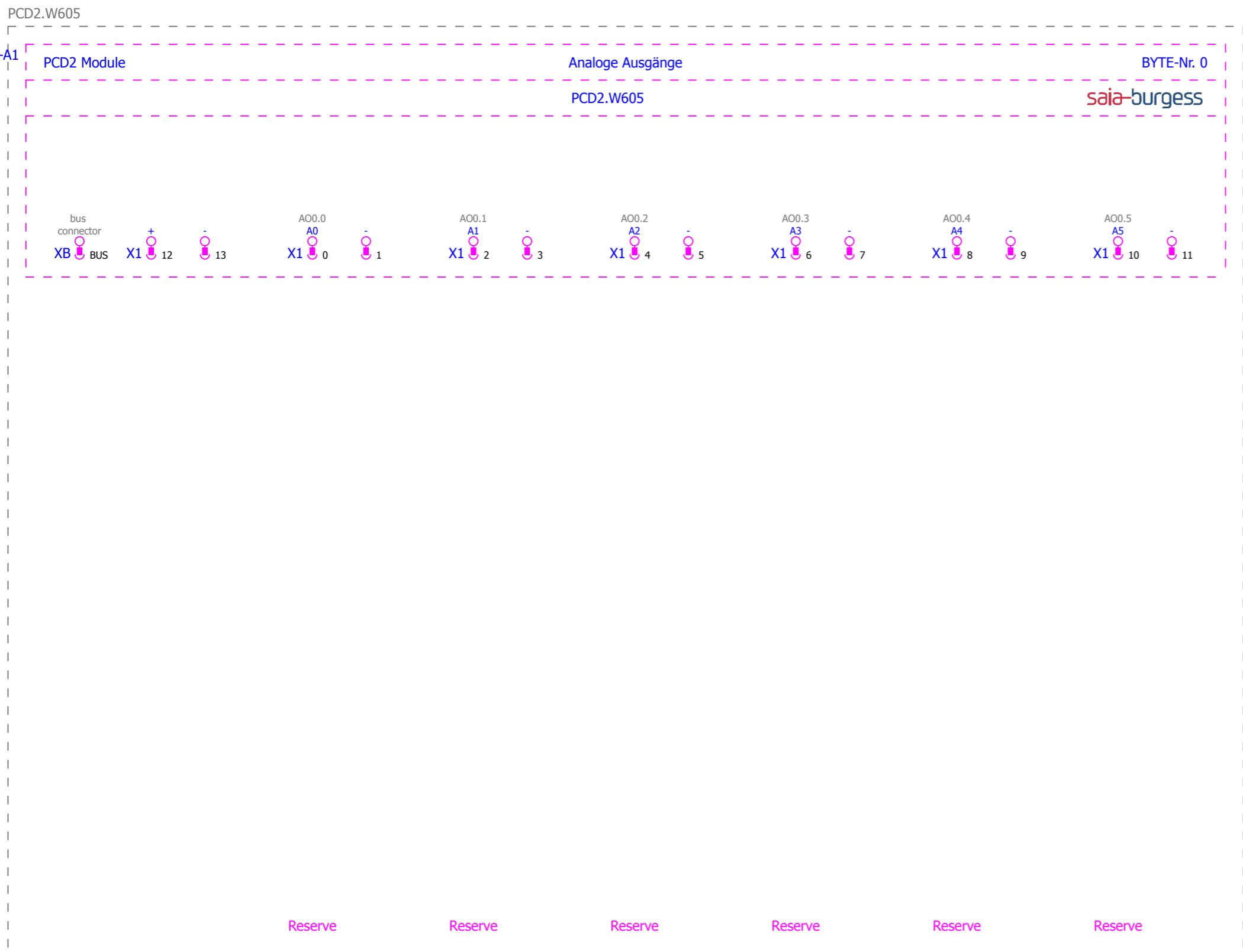

Saia-Burgess\PCD2 Module\PCD2.W605.ema
 Multi-line
 Variant A
 2012-10-26 / 2.1.4

+W610/10

10

			Datum	26.10.2012	EPLAN Software & Service Saia-Burgess Makroprojekt	Saia-Burgess Controls Ltd. Control Systems and Components	Saia-Burgess Controls Ltd.	Allpolig	= PCD2 Module	
		Bearb.	KAF	+ PCD2.W605						
		Gepr		Blatt					1	
Änderung	Datum	Name	Urspr	Ersatz von	Ersetzt durch				Blatt	522

PCD2.W605



bus connector

Reserve

Reserve

Reserve

Reserve

Reserve

Reserve

Saia-Burgess\PCD2 Module\PCD2.W605.ema
 Overview
 Variant A
 2012-10-26 / 2.1.4

			Datum	26.10.2012	EPLAN Software & Service Saia-Burgess Makroprojekt	Saia-Burgess Controls Ltd. Control Systems and Components	Saia-Burgess Controls Ltd.	SPS-Übersicht	= PCD2 Module		Blatt 10
			Bearb.	KAF					+ PCD2.W605		
			Gepr								
Änderung	Datum	Name	Urspr		Ersatz von	Ersetzt durch					

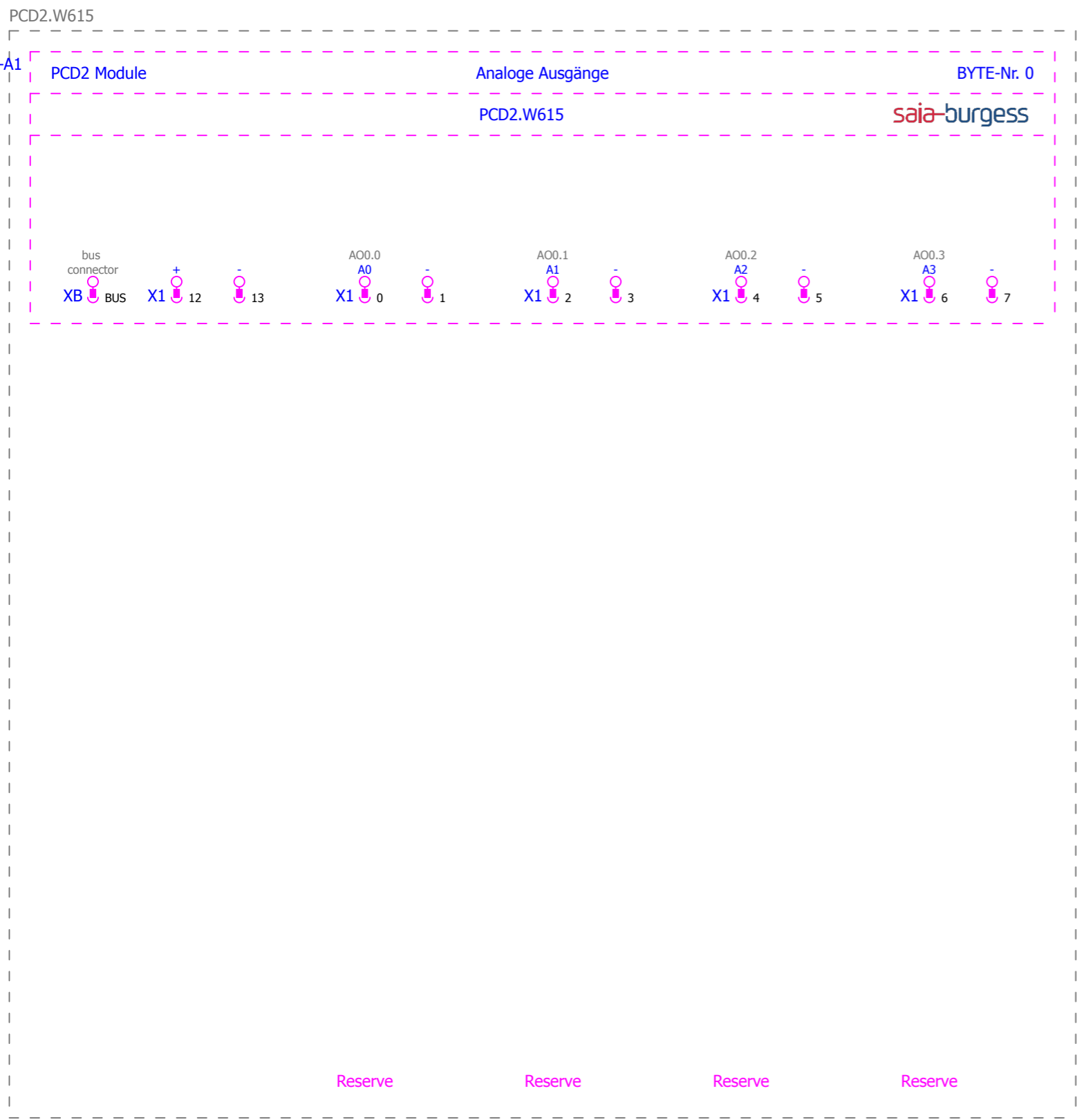

Saia-Burgess\PCD2 Module\PCD2.W615.ema
 Multi-line
 Variant A
 2012-10-26 / 2.1.4

+ .W605/10

10

			Datum	26.10.2012	EPLAN Software & Service Saia-Burgess Makroprojekt	 Control Systems and Components	Saia-Burgess Controls Ltd.	Allpolig		= PCD2 Module	
			Bearb.	KAF						+ PCD2.W615	
			Gepr								Blatt 1
Änderung	Datum	Name	Urspr		Ersatz von	Ersetzt durch				Blatt 522	

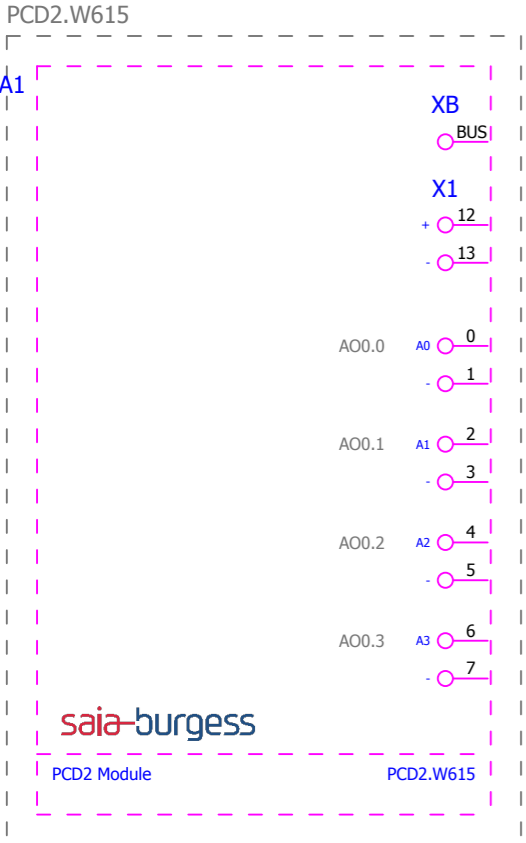

bus connector

Reserve

Reserve

Reserve

Reserve

Saia-Burgess\PCD2 Module\PCD2.W615.ema
 Overview
 Variant A
 2012-10-26 / 2.1.4

			Datum	26.10.2012	EPLAN Software & Service Saia-Burgess Makroprojekt	Saia-Burgess Controls Ltd. Control Systems and Components	Saia-Burgess Controls Ltd.	SPS-Übersicht	= PCD2 Module		Blatt 10
			Bearb.	KAF					+ PCD2.W615		
			Gepr								
Änderung	Datum	Name	Urspr		Ersatz von	Ersetzt durch				Blatt	522

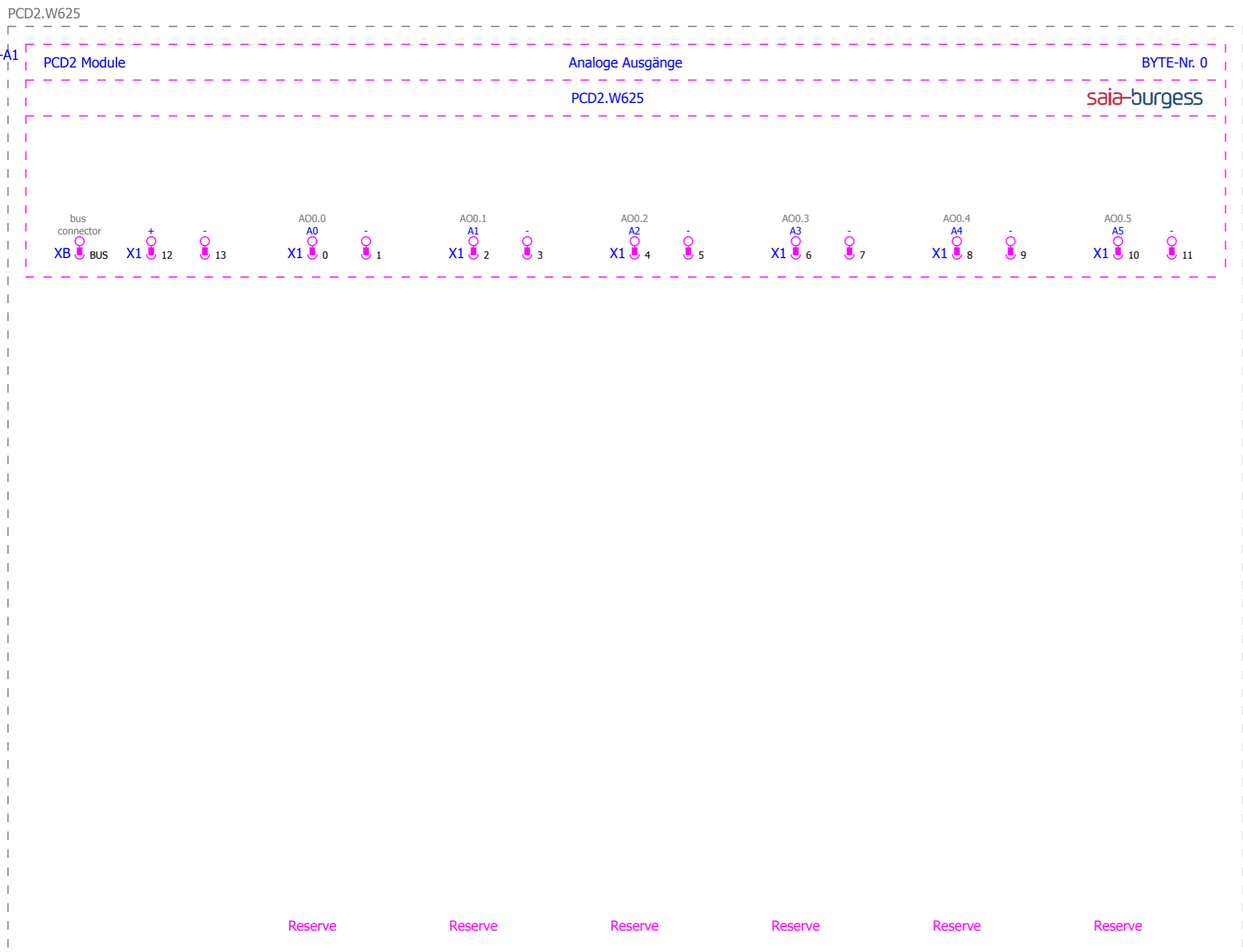

Saia-Burgess\PCD2 Module\PCD2.W625.ema
 Multi-line
 Variant A
 2012-10-26 / 2.1.4

+ .W615/10

			Datum	26.10.2012	EPLAN Software & Service Saia-Burgess Makroprojekt	Saia-Burgess Controls Ltd. <small>Control Systems and Components</small>	Allpolig	= PCD2 Module	
			Bearb.	KAF				+ PCD2.W625	
			Gepr					Blatt	1
Änderung	Datum	Name	Urspr		Ersatz von	Ersetzt durch		Blatt	522



Saia-Burgess\PCD2 Module\PCD2.W625.ema
Overview
Variant A
2012-10-26 / 2.1.4

			Datum	26.10.2012	EPLAN Software & Service Saia-Burgess Makroprojekt	Saia-Burgess Controls Ltd. Control Systems and Components	Saia-Burgess Controls Ltd.	SPS-Übersicht	= PCD2 Module		Blatt 10
		Bearb.	KAF	+ PCD2.W625							
		Gepr									
Änderung	Datum	Name	Urspr		Ersatz von	Ersetzt durch				Blatt 522	

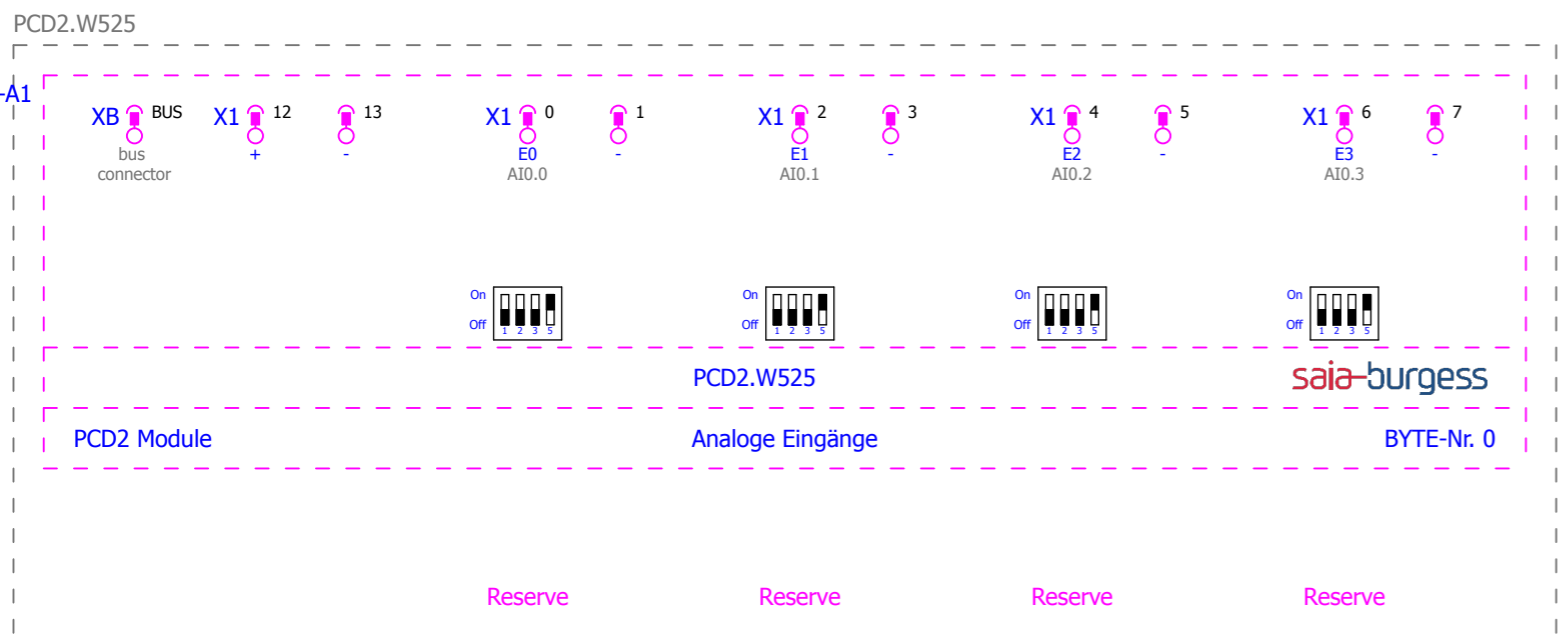

Saia-Burgess\PCD2 Module\PCD2.W525.ema
 Multi-line
 Variant A
 2012-10-26 / 2.1.4

+ .W625/10

			Datum	26.10.2012	EPLAN Software & Service Saia-Burgess Makroprojekt	 Control Systems and Components	Saia-Burgess Controls Ltd.	Allpolig		= PCD2 Module		
			Bearb.	KAF							+ PCD2.W525	
			Gepr									Blatt
Änderung	Datum	Name	Urspr		Ersatz von	Ersetzt durch					Blatt	522

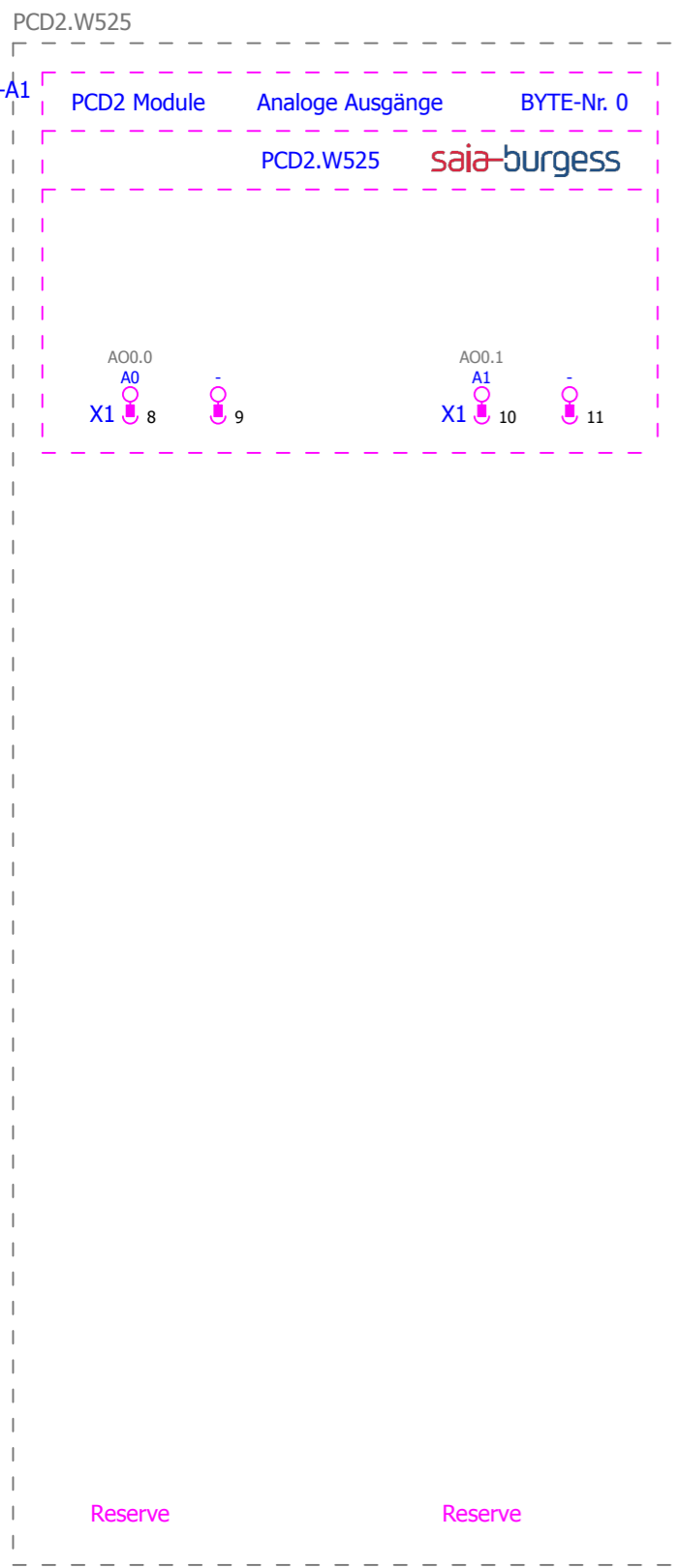

Saia-Burgess\PCD2 Module\PCD2.W525.ema
 Multi-line
 Variant B
 2012-10-26 / 2.1.4

			Datum	26.10.2012	EPLAN Software & Service Saia-Burgess Makroprojekt	Saia-Burgess Controls Ltd.	Allpolig	= PCD2 Module	
			Bearb.	KAF				+ PCD2.W525	
			Gepr					Blatt	2
Änderung	Datum	Name	Urspr	Ersatz von	Ersetzt durch			Blatt	522



bus connector
Reserve
Reserve
Reserve
Reserve
Reserve
Reserve

Saia-Burgess
PCD2 Module PCD2.W525
Saia-Burgess\PCD2 Module\PCD2.W525.ema
Overview
Variant A
2012-10-26 / 2.1.4

			Datum	26.10.2012	EPLAN Software & Service Saia-Burgess Makroprojekt	Saia-Burgess Controls Ltd. Control Systems and Components	Saia-Burgess Controls Ltd.	SPS-Übersicht	= PCD2 Module		Blatt 10
			Bearb.	KAF					+ PCD2.W525		
			Gepr								
Änderung	Datum	Name	Urspr		Ersatz von	Ersetzt durch				Blatt	522

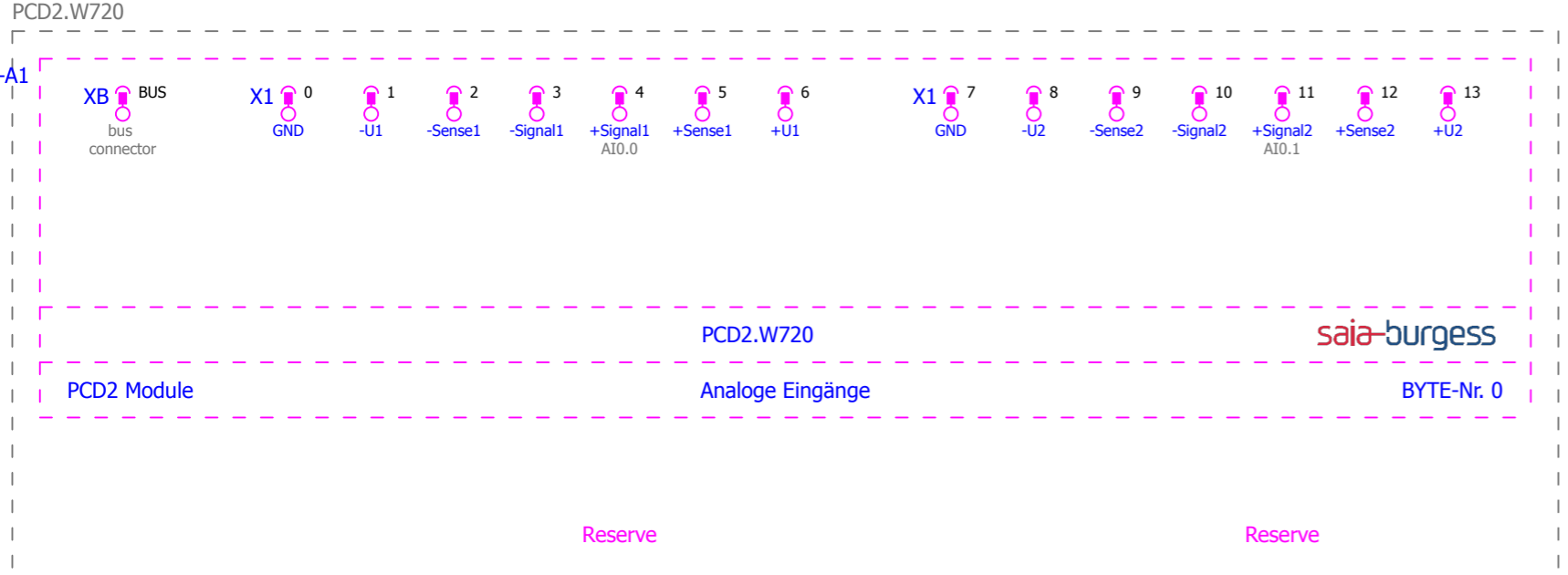

Saia-Burgess\PCD2 Module\PCD2.W720.ema
 Multi-line
 Variant A
 2012-10-26 / 2.1.4

			Datum	26.10.2012	EPLAN Software & Service Saia-Burgess Makroprojekt	 Control Systems and Components	Saia-Burgess Controls Ltd.	Allpolig	= PCD2 Module	
			Bearb.	KAF					+ PCD2.W720	
			Gepr							
Änderung	Datum	Name	Urspr		Ersatz von	Ersetzt durch			Blatt	1
									Blatt	522



bus connector

Reserve

Reserve

Saia-Burgess\PCD2 Module\PCD2.W720.ema
 Overview
 Variant A
 2012-10-26 / 2.1.4

			Datum	26.10.2012	EPLAN Software & Service Saia-Burgess Makroprojekt	Saia-Burgess Controls Ltd. Control Systems and Components	Saia-Burgess Controls Ltd.	SPS-Übersicht	= PCD2 Module		Blatt 10
		Bearb.	KAF	+ PCD2.W720							
		Gepr									
Änderung	Datum	Name	Üspr	Ersatz von	Ersetzt durch					Blatt	522

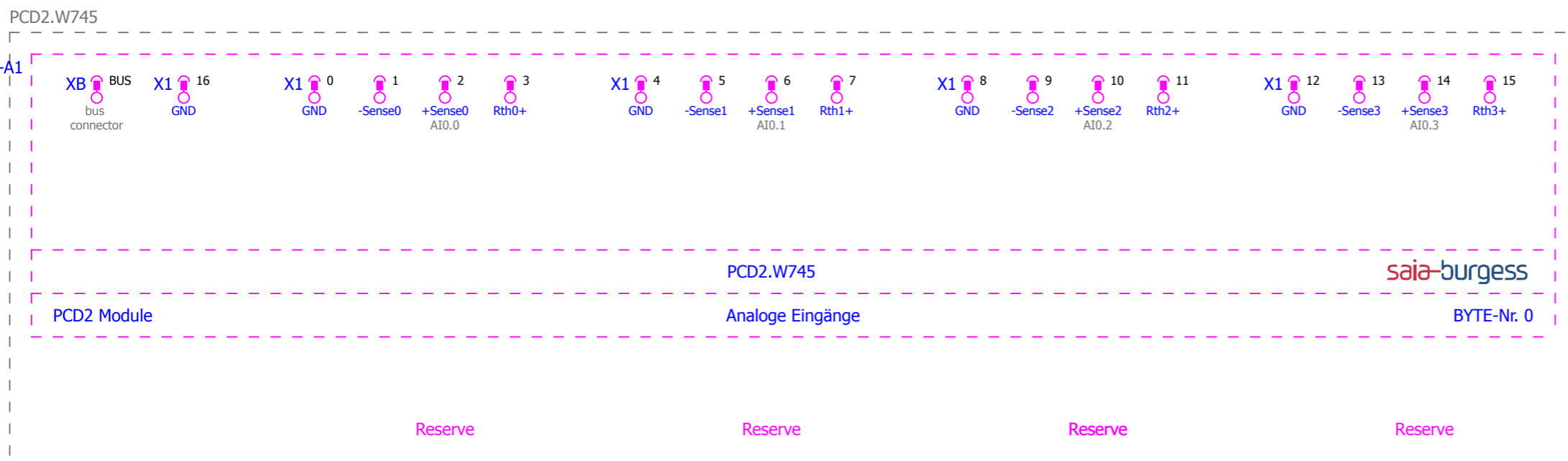

Saia-Burgess\PCD2 Module\PCD2.W745.ema
 Multi-line
 Variant A
 2012-10-26 / 2.1.4

+.W720/10

			Datum	26.10.2012	EPLAN Software & Service Saia-Burgess Makroprojekt	Saia-Burgess Controls Ltd. Control Systems and Components	Saia-Burgess Controls Ltd.	Allpolig	= PCD2 Module		Blatt 1
			Bearb.	KAF					+ PCD2.W745		
			Gepr								
Änderung	Datum	Name	Urspr		Ersatz von	Ersetzt durch				Blatt	522



bus connector

Reserve

Reserve

Reserve

Reserve

Saia-Burgess\PCD2 Module\PCD2.W745.ema
 Overview
 Variant A
 2012-10-26 / 2.1.4

			Datum	26.10.2012	EPLAN Software & Service Saia-Burgess Makroprojekt	Saia-Burgess Controls Ltd. Control Systems and Components	Saia-Burgess Controls Ltd.	SPS-Übersicht	= PCD2 Module		Blatt 10
			Bearb.	KAF					+ PCD2.W745		
			Gepr								
Änderung	Datum	Name	Üspr		Ersatz von	Ersetzt durch				Blatt 522	



Saia-Burgess\PCD2 Module\PCD2.H222.ema
 Multi-line
 Variant A
 2012-10-26 / 2.1.4

+.W745/10

			Datum	26.10.2012	EPLAN Software & Service Saia-Burgess Makroprojekt	Saia-Burgess Controls Ltd. <small>Control Systems and Components</small>	Allpolig	= PCD2 Module	
		Bearb.	KAF	+ PCD2.H222					
		Gepr		Blatt				1	
Änderung	Datum	Name	Urspr	Ersatz von	Ersetzt durch			Blatt	522

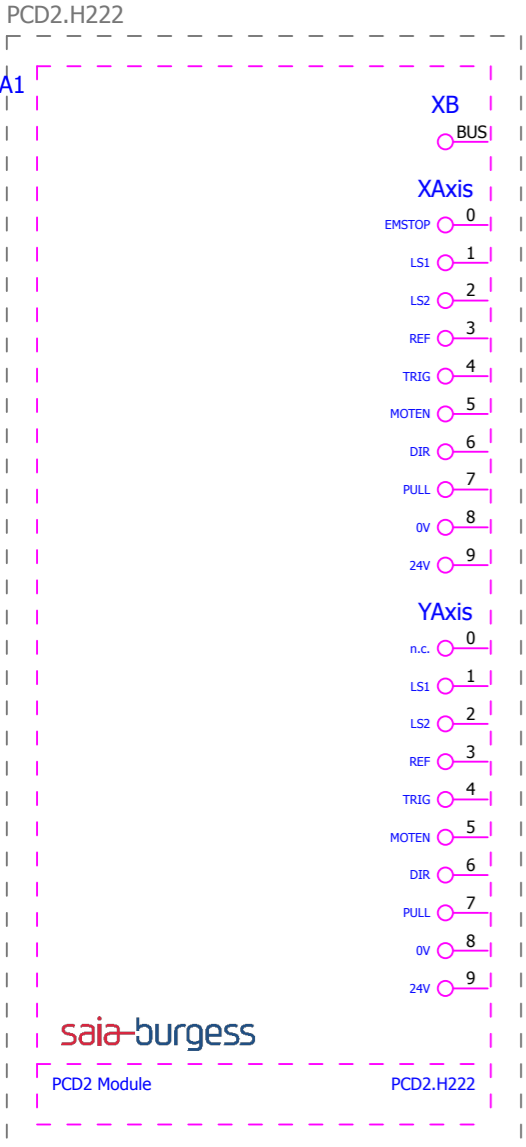

bus connector

Saia-Burgess\PCD2 Module\PCD2.H222.ema
 Overview
 Variant A
 2012-10-26 / 2.1.4

			Datum	26.10.2012	EPLAN Software & Service Saia-Burgess Makroprojekt	Saia-Burgess Controls Ltd. Control Systems and Components	Saia-Burgess Controls Ltd.	SPS-Übersicht	= PCD2 Module		Blatt 10
			Bearb.	KAF					+ PCD2.H222		
			Gepr								
Änderung	Datum	Name	Ürspr		Ersatz von	Ersetzt durch				Blatt	522

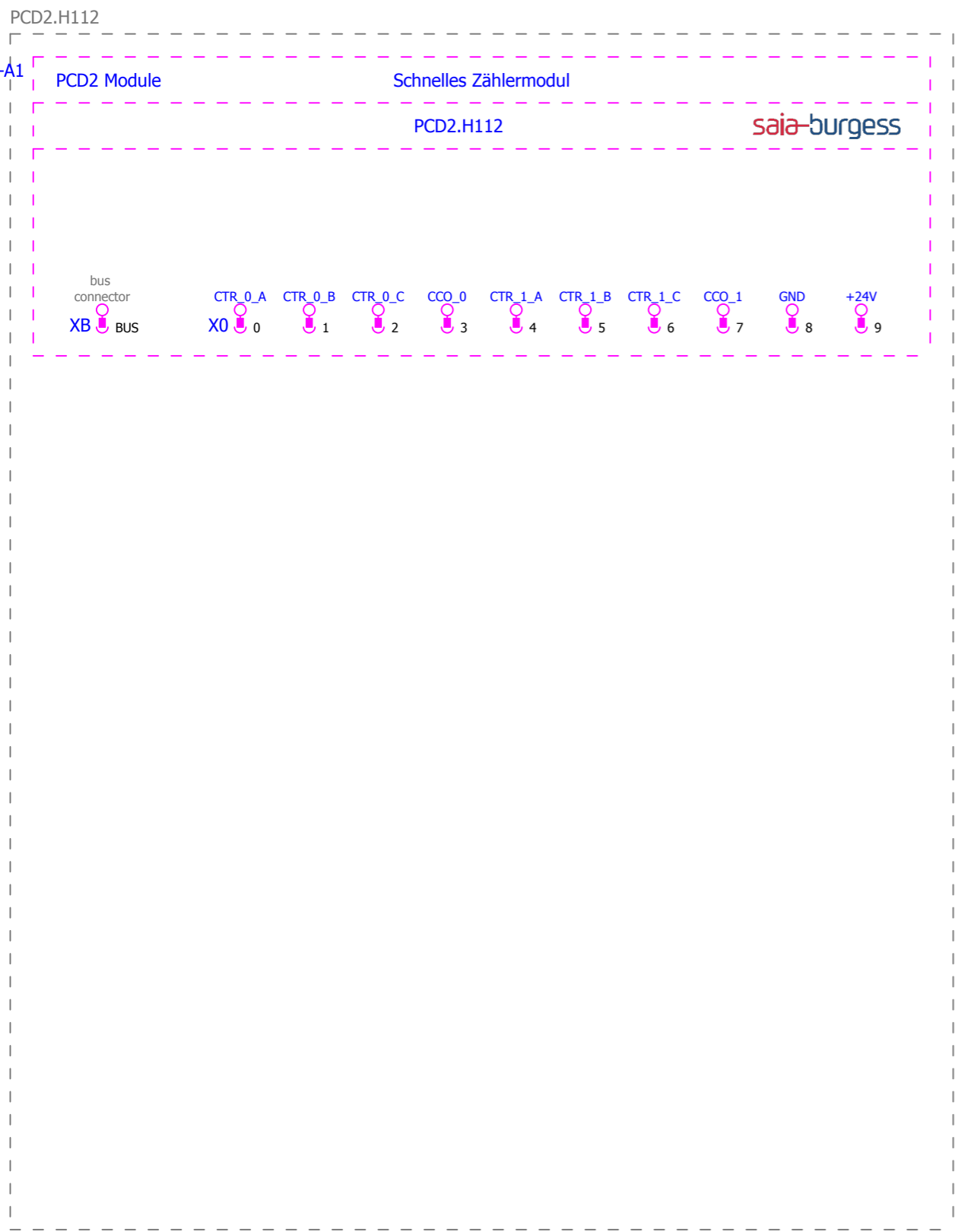

Saia-Burgess\PCD2 Module\PCD2.H112.ema
 Multi-line
 Variant A
 2012-10-26 / 2.1.4

+.H222/10

10

			Datum	26.10.2012	EPLAN Software & Service Saia-Burgess Makroprojekt	Saia-Burgess Controls Ltd. <small>Control Systems and Components</small>	Allpolig	= PCD2 Module		Blatt 1
		Bearb.	KAF	+ PCD2.H112						
		Gepr								
Änderung	Datum	Name	Urspr	Ersatz von	Ersetzt durch				Blatt	522

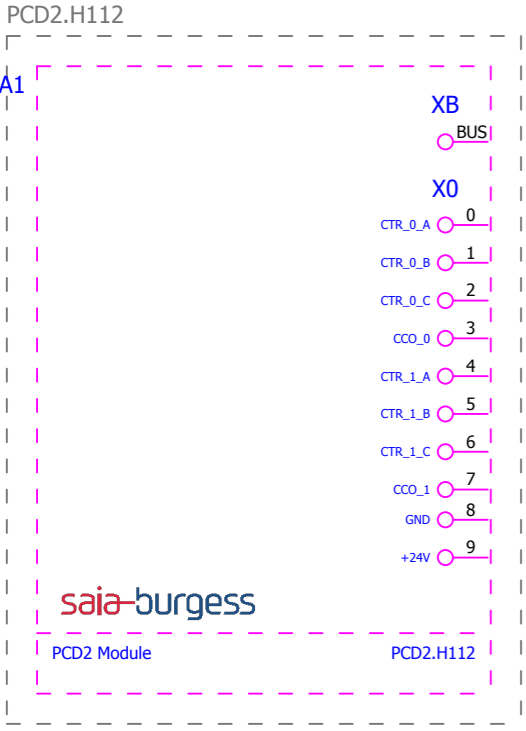

bus connector



Saia-Burgess\PCD2 Module\PCD2.H112.ema
 Overview
 Variant A
 2012-10-26 / 2.1.4

			Datum	26.10.2012	EPLAN Software & Service Saia-Burgess Makroprojekt	Saia-Burgess Controls Ltd. Control Systems and Components	Saia-Burgess Controls Ltd.	SPS-Übersicht	= PCD2 Module		Blatt 10
		Bearb.	KAF	+ PCD2.H112							
		Gepr									
Änderung	Datum	Name	Üspr		Ersatz von	Ersetzt durch				Blatt	522



Saia-Burgess\PCD2 Module\PCD2.H114.ema
 Multi-line
 Variant A
 2012-10-26 / 2.1.4

			Datum	26.10.2012	EPLAN Software & Service Saia-Burgess Makroprojekt	Saia-Burgess Controls Ltd. <small>Control Systems and Components</small>	Allpolig	= PCD2 Module		Blatt 1	
			Bearb.	KAF				+ PCD2.H114			Blatt 522
			Gepr								
Änderung	Datum	Name	Urspr		Ersatz von	Ersetzt durch					

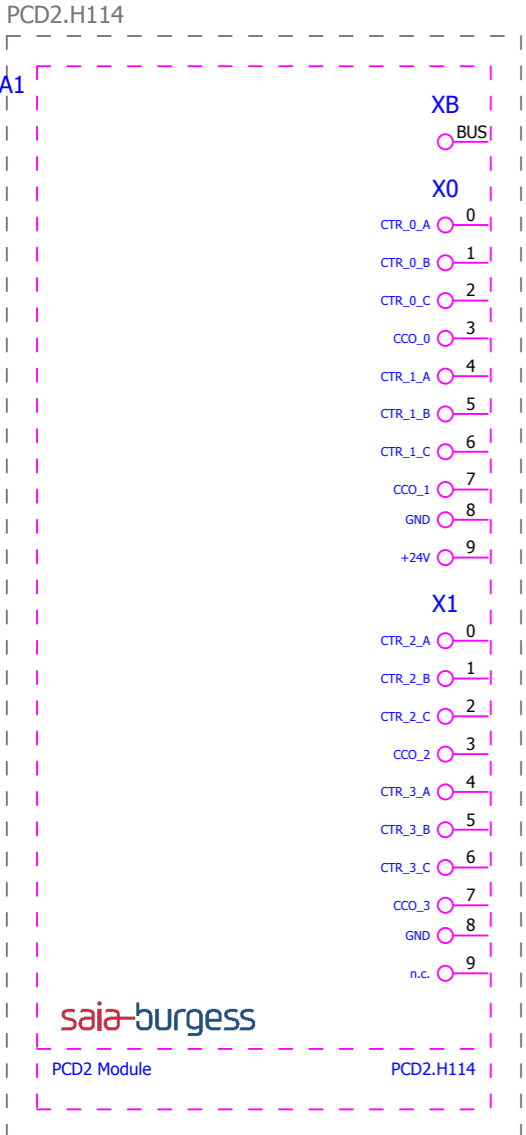

bus connector

Saia-Burgess\PCD2 Module\PCD2.H114.ema
Overview
Variant A
2012-10-26 / 2.1.4

			Datum	26.10.2012	EPLAN Software & Service Saia-Burgess Makroprojekt	Saia-Burgess Controls Ltd. Control Systems and Components	Saia-Burgess Controls Ltd.	SPS-Übersicht	= PCD2 Module		Blatt 10
		Bearb.	KAF	+ PCD2.H114							
		Gepr							Blatt 522		
Änderung	Datum	Name	Urspr	Ersatz von	Ersetzt durch						

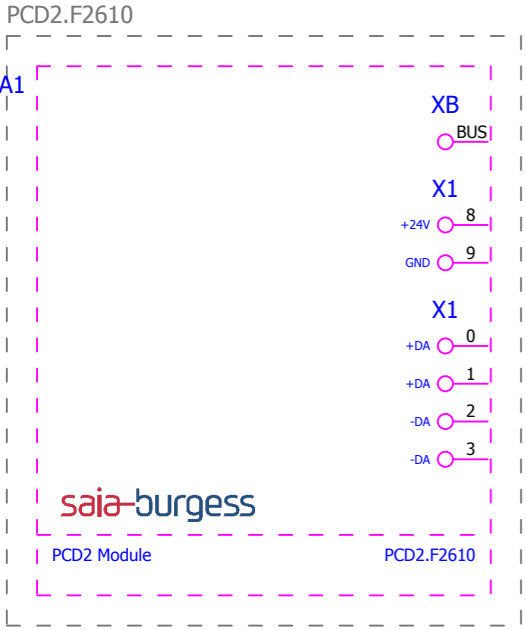

Saia-Burgess\PCD2 Module\PCD2.F2610.ema
 Overview
 Variant A
 2012-10-26 / 2.1.4

			Datum	26.10.2012	EPLAN Software & Service Saia-Burgess Makroprojekt	Saia-Burgess Controls Ltd. Control Systems and Components	Saia-Burgess Controls Ltd.	SPS-Übersicht	= PCD2 Module		Blatt 10
		Bearb.	KAF	+ PCD2.F2610							
		Gepr									
Änderung	Datum	Name	Urspr		Ersatz von	Ersetzt durch				Blatt	522

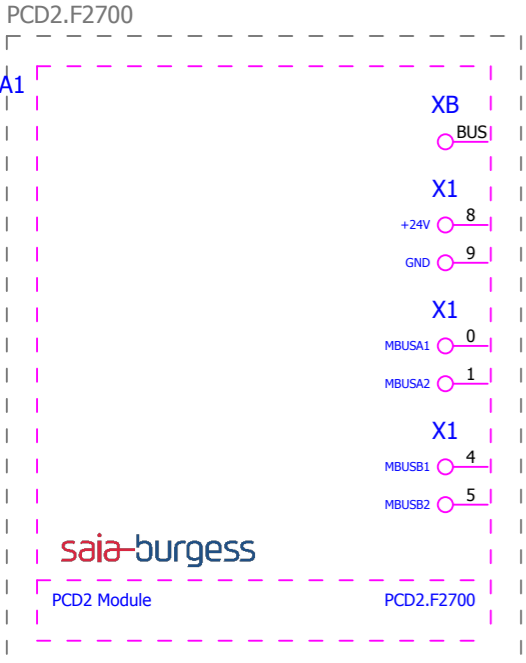

bus connector

Saia-Burgess\PCD2 Module\PCD2.F2700.ema
 Overview
 Variant A
 2012-10-26 / 2.1.4

			Datum	26.10.2012	EPLAN Software & Service Saia-Burgess Makroprojekt	Saia-Burgess Controls Ltd. Control Systems and Components	Saia-Burgess Controls Ltd.	SPS-Übersicht	= PCD2 Module		Blatt 10
		Bearb.	KAF	+ PCD2.F2700							
		Gepr									
Änderung	Datum	Name	Urspr		Ersatz von	Ersetzt durch				Blatt	522

PCD2.F2710

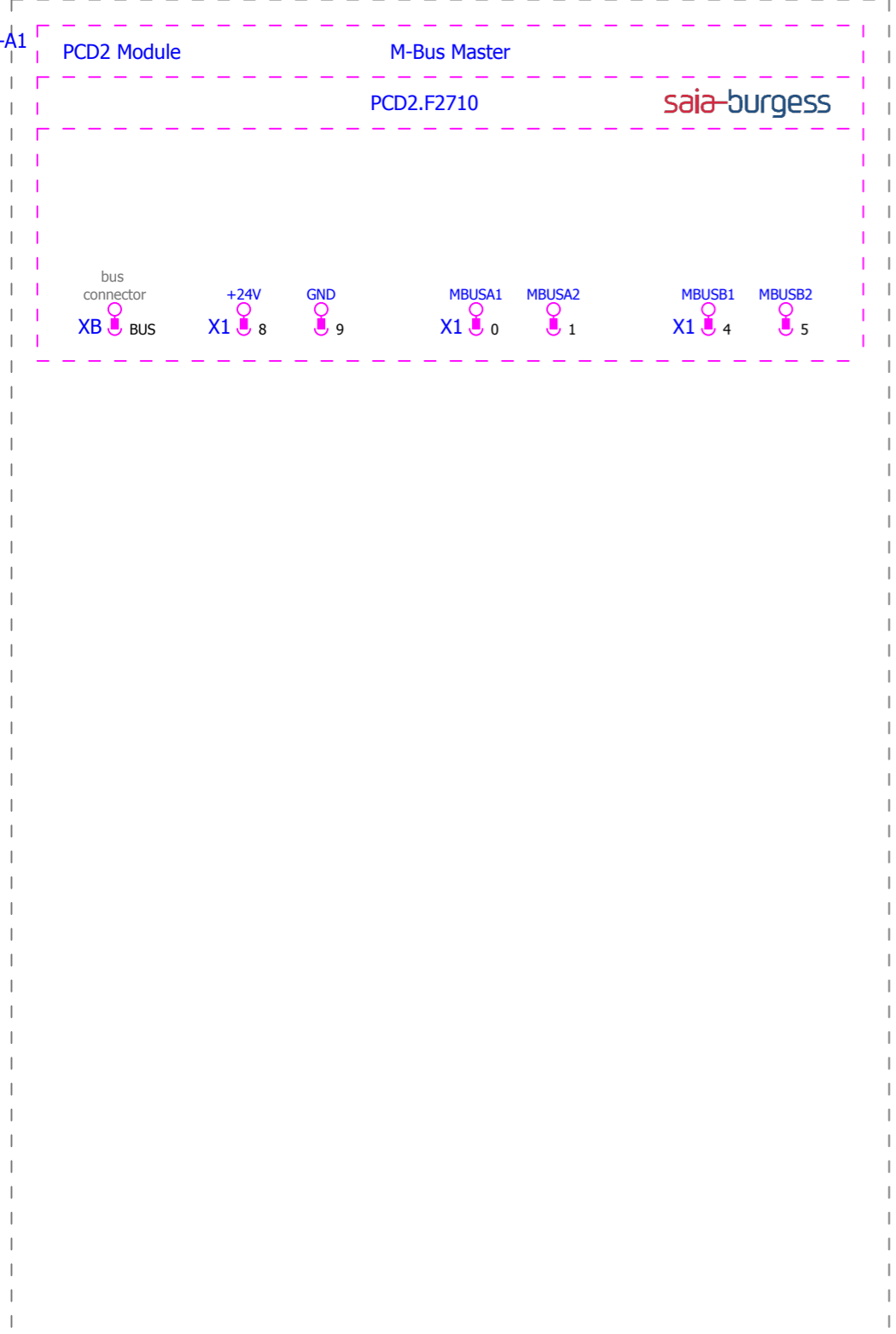

Saia-Burgess\PCD2 Module\PCD2.F2710.ema
 Multi-line
 Variant A
 2012-10-26 / 2.1.4

+.F2700/10

10

			Datum	26.10.2012	EPLAN Software & Service Saia-Burgess Makroprojekt	Saia-Burgess Controls Ltd. <small>Control Systems and Components</small>	Allpolig	= PCD2 Module		
		Bearb.	KAF	+ PCD2.F2710						
		Gepr						Blatt	1	
Änderung	Datum	Name	Urspr		Ersatz von	Ersetzt durch			Blatt	522

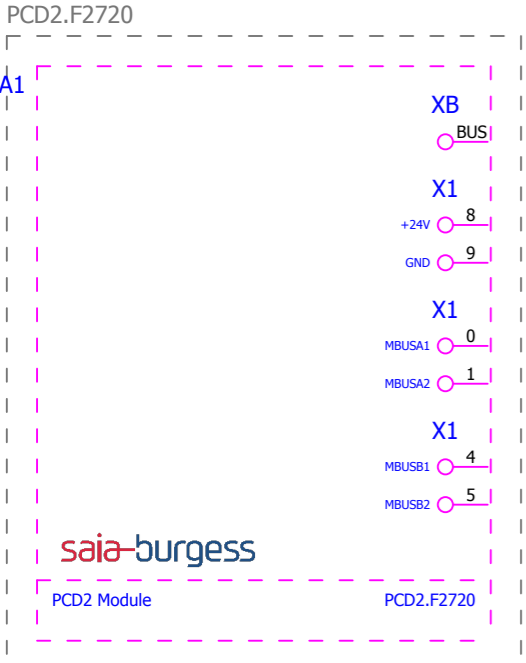

Saia-Burgess\PCD2 Module\PCD2.F2720.ema
 Overview
 Variant A
 2012-10-26 / 2.1.4

			Datum	26.10.2012	EPLAN Software & Service Saia-Burgess Makroprojekt	Saia-Burgess Controls Ltd. Control Systems and Components	Saia-Burgess Controls Ltd.	SPS-Übersicht	= PCD2 Module		Blatt 10
		Bearb.	KAF	+ PCD2.F2720							
		Gepr									
Änderung	Datum	Name	Urspr		Ersatz von	Ersetzt durch				Blatt	522

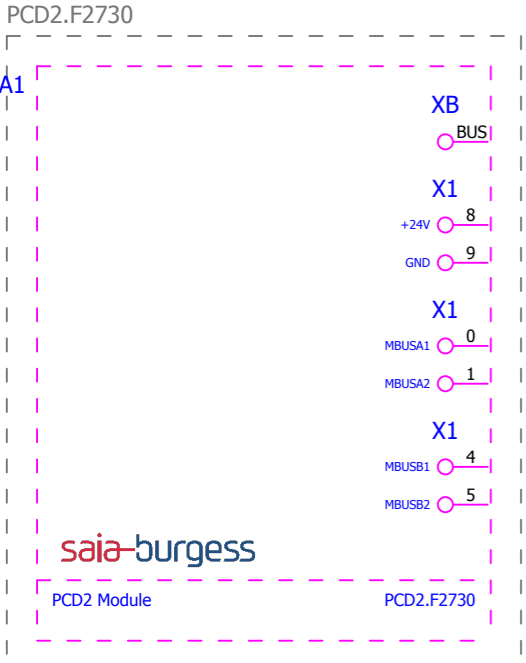

Saia-Burgess\PCD2 Module\PCD2.F2730.ema
 Overview
 Variant A
 2012-10-26 / 2.1.4

			Datum	26.10.2012	EPLAN Software & Service Saia-Burgess Makroprojekt	Saia-Burgess Controls Ltd. Control Systems and Components	Saia-Burgess Controls Ltd.	SPS-Übersicht	= PCD2 Module		Blatt 10
		Bearb.	KAF	+ PCD2.F2730							
		Gepr									
Änderung	Datum	Name	Urspr		Ersatz von	Ersetzt durch				Blatt	522



Saia-Burgess\PCD2 Module\PCD2.K510.ema
 Multi-line
 Variant A
 2012-10-26 / 2.1.4

			Datum	26.10.2012	EPLAN Software & Service Saia-Burgess Makroprojekt	Saia-Burgess Controls Ltd. Control Systems and Components	Saia-Burgess Controls Ltd.	Allpolig	= PCD2 Module	
			Bearb.	KAF					+ PCD2.K510	
			Gepr						Blatt	1
Änderung	Datum	Name	Urspr		Ersatz von	Ersetzt durch			Blatt	522

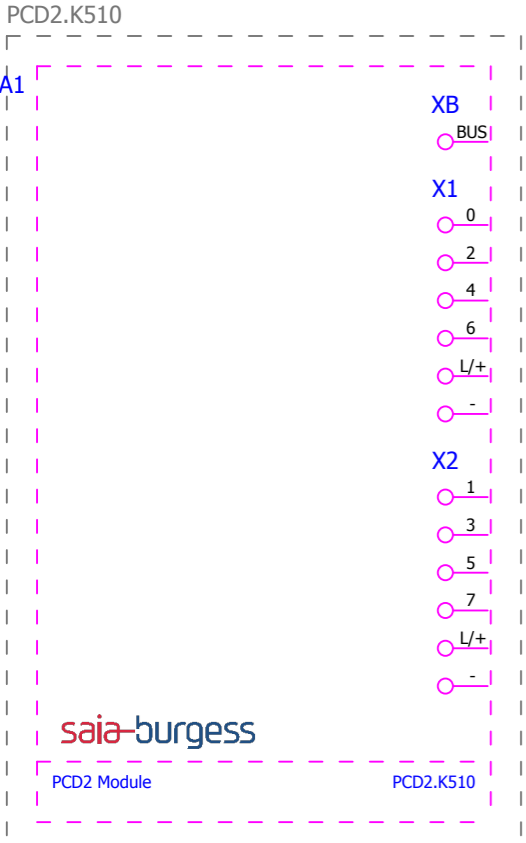

bus connector

Saia-Burgess\PCD2 Module\PCD2.K510.ema
 Overview
 Variant A
 2012-10-26 / 2.1.4

			Datum	26.10.2012	EPLAN Software & Service Saia-Burgess Makroprojekt	Saia-Burgess Controls Ltd. Control Systems and Components	Saia-Burgess Controls Ltd.	SPS-Übersicht	= PCD2 Module		Blatt 10
			Bearb.	KAF					+ PCD2.K510		
			Gepr								
Änderung	Datum	Name	Urspr		Ersatz von	Ersetzt durch				Blatt	522

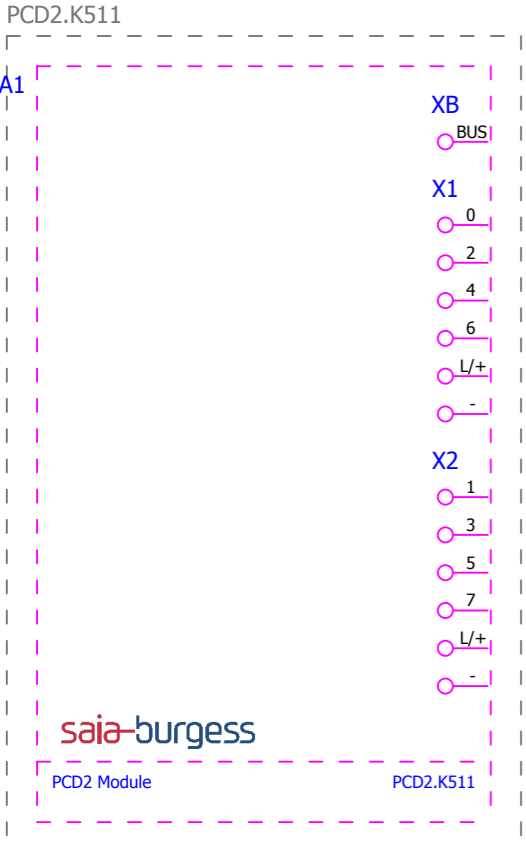

bus connector

Saia-Burgess\PCD2 Module\PCD2.K511.ema
 Overview
 Variant A
 2012-10-26 / 2.1.4

			Datum	26.10.2012	EPLAN Software & Service Saia-Burgess Makroprojekt	Saia-Burgess Controls Ltd. Control Systems and Components	Saia-Burgess Controls Ltd.	SPS-Übersicht	= PCD2 Module		Blatt 10
			Bearb.	KAF					+ PCD2.K511		
			Gepr								
Änderung	Datum	Name	Urspr		Ersatz von	Ersetzt durch				Blatt	522

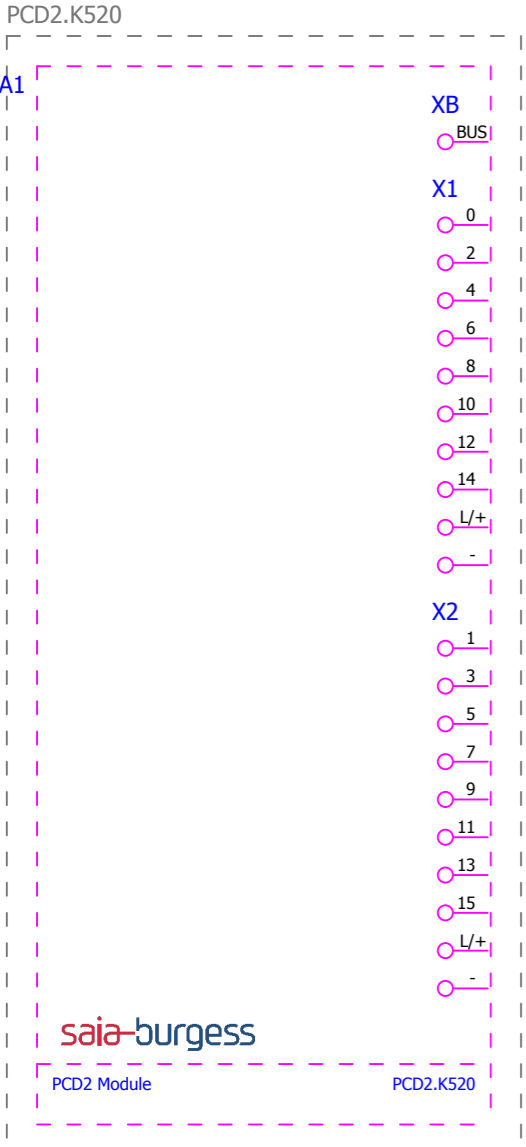

bus connector

Saia-Burgess\PCD2 Module\PCD2.K520.ema
 Overview
 Variant A
 2012-10-26 / 2.1.4

			Datum	26.10.2012	EPLAN Software & Service Saia-Burgess Makroprojekt	 Control Systems and Components	Saia-Burgess Controls Ltd.	SPS-Übersicht	= PCD2 Module		Blatt 10
		Bearb.	KAF	+ PCD2.K520							
		Gepr									
Änderung	Datum	Name	Urspr		Ersatz von	Ersetzt durch				Blatt	522

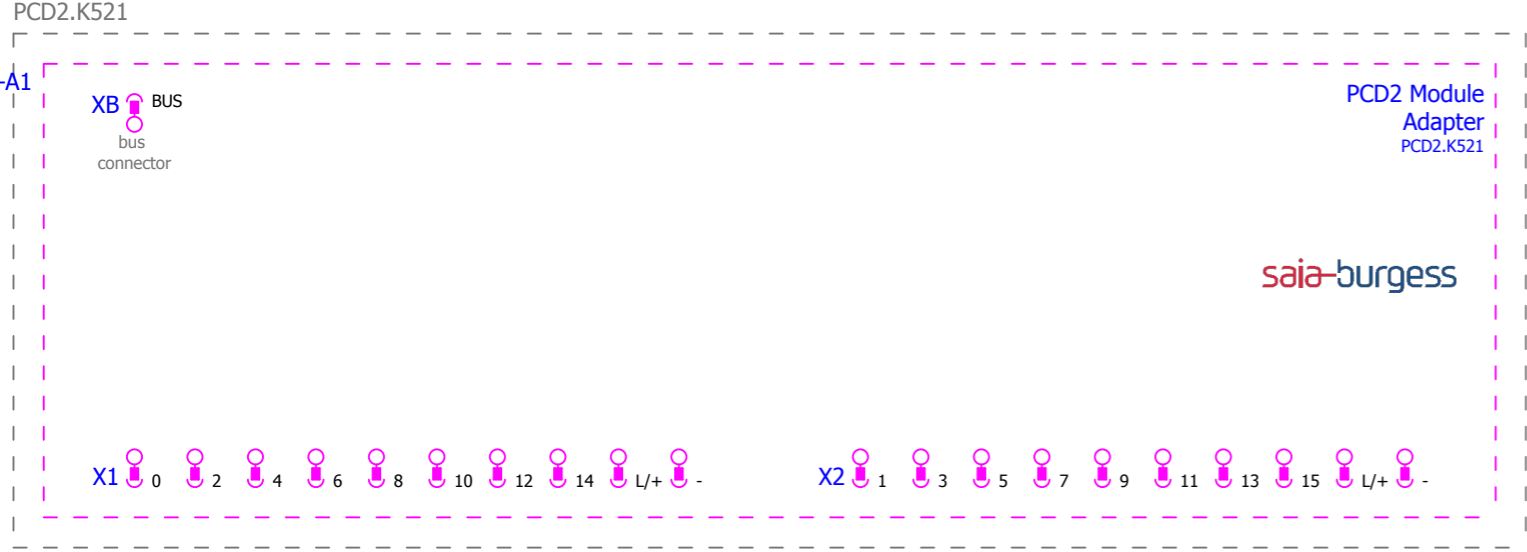

Saia-Burgess\PCD2 Module\PCD2.K521.ema
 Multi-line
 Variant A
 2012-10-26 / 2.1.4

		Datum 26.10.2012		EPLAN Software & Service Saia-Burgess Makroprojekt	 Control Systems and Components	Saia-Burgess Controls Ltd.		Allpolig		= PCD2 Module		
		Bearb. KAF								+ PCD2.K521		Blatt 1
		Gepr										Blatt 522
Änderung	Datum	Name	Urspr	Ersatz von	Ersetzt durch							

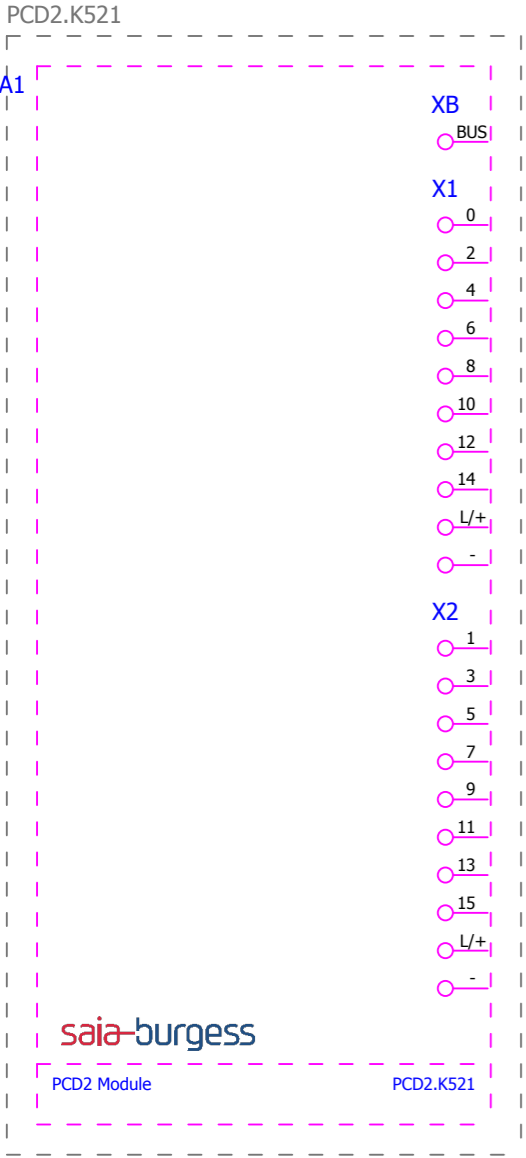

bus connector

Saia-Burgess\PCD2 Module\PCD2.K521.ema
 Overview
 Variant A
 2012-10-26 / 2.1.4

			Datum	26.10.2012	EPLAN Software & Service Saia-Burgess Makroprojekt	Saia-Burgess Controls Ltd. Control Systems and Components	Saia-Burgess Controls Ltd.	SPS-Übersicht	= PCD2 Module		Blatt 10
		Bearb.	KAF	+ PCD2.K521							
		Gepr									
Änderung	Datum	Name	Urspr		Ersatz von	Ersetzt durch				Blatt	522

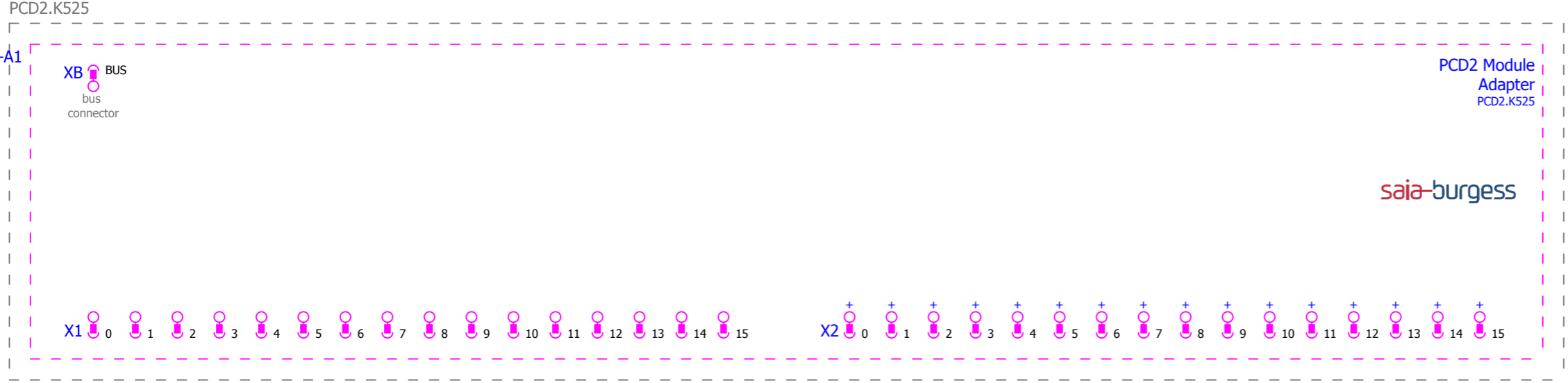

Saia-Burgess\PCD2 Module\PCD2.K525.ema
 Multi-line
 Variant A
 2012-10-26 / 2.1.4

			Datum	26.10.2012	EPLAN Software & Service Saia-Burgess Makroprojekt	Saia-Burgess Controls Ltd. Control Systems and Components	Saia-Burgess Controls Ltd.	Allpolig	= PCD2 Module	
			Bearb.	KAF					+ PCD2.K525	
			Gepr						Blatt	1
Änderung	Datum	Name	Urspr		Ersatz von	Ersetzt durch			Blatt	522

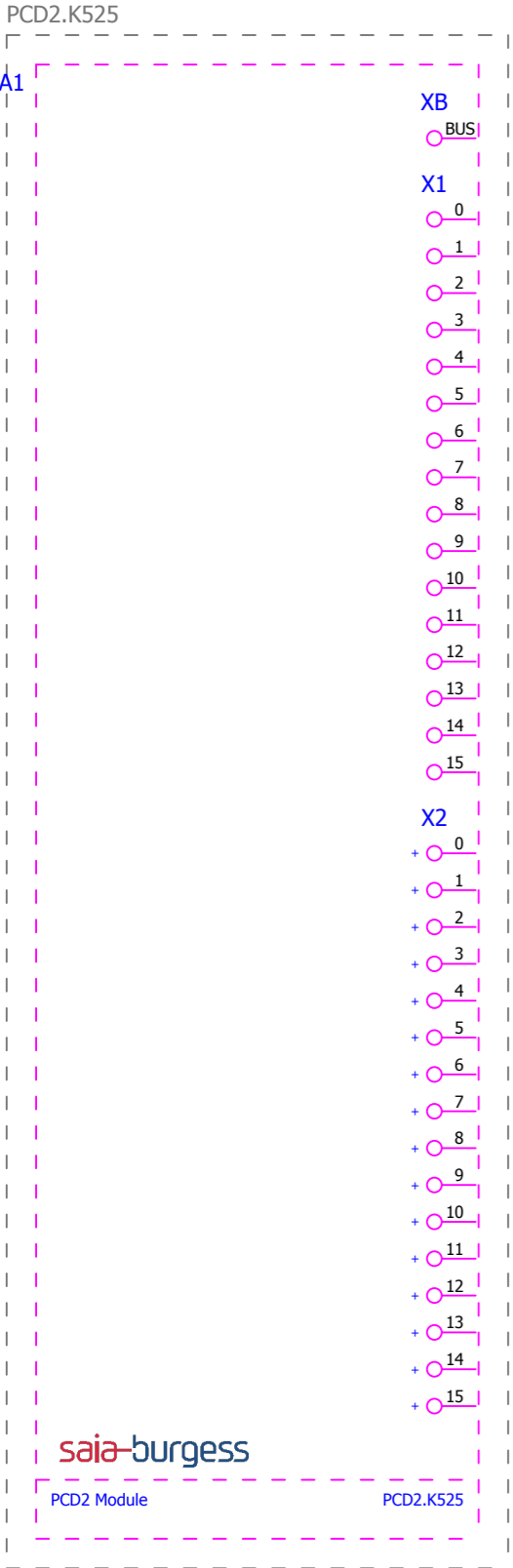

Saia-Burgess\PCD2 Module\PCD2.K525.ema
 Overview
 Variant A
 2012-10-26 / 2.1.4

bus connector

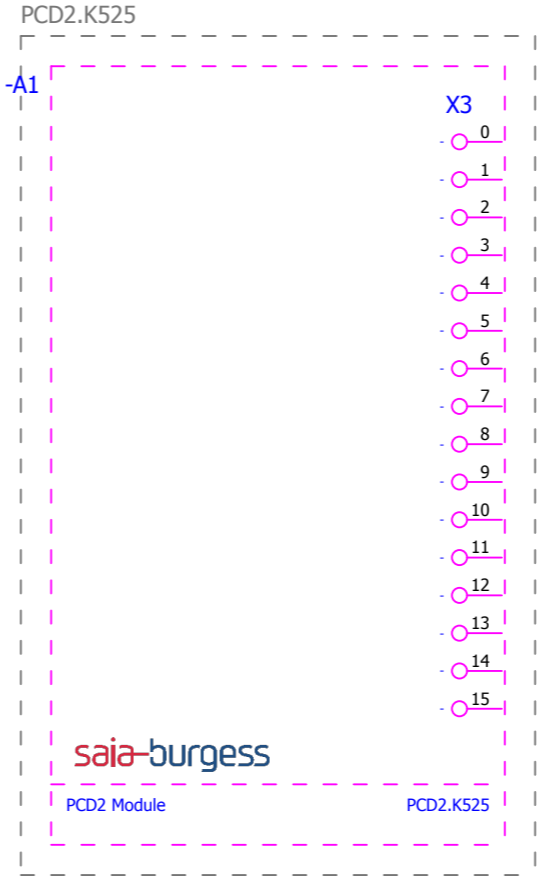

Saia-Burgess\PCD2 Module\PCD2.K525.ema
 Overview
 Variant B
 2012-10-26 / 2.1.4

			Datum	26.10.2012	EPLAN Software & Service Saia-Burgess Makroprojekt	Saia-Burgess Controls Ltd. Control Systems and Components	Saia-Burgess Controls Ltd.	SPS-Übersicht	= PCD2 Module	
			Bearb.	KAF					+ PCD2.K525	
			Gepr						Blatt	10
Änderung	Datum	Name	Urspr	Ersatz von	Ersetzt durch			Blatt	522	

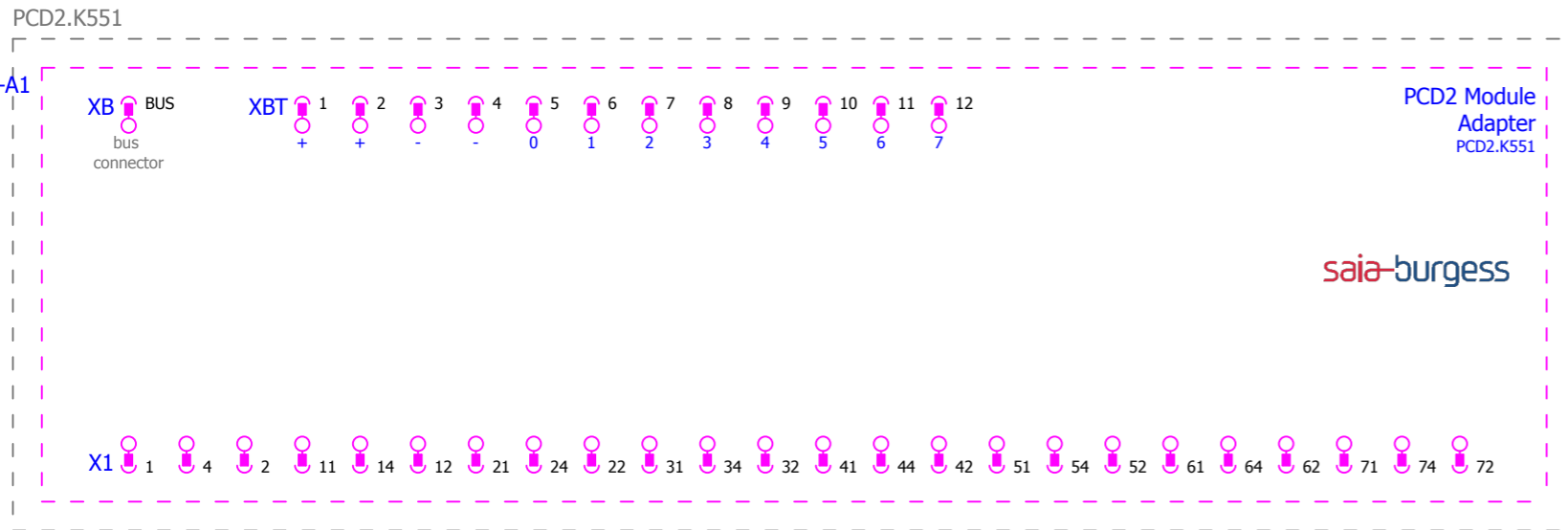

Saia-Burgess\PCD2 Module\PCD2.K551.ema
 Multi-line
 Variant A
 2012-10-26 / 2.1.4

			Datum	26.10.2012	EPLAN Software & Service Saia-Burgess Makroprojekt	Control Systems and Components	Saia-Burgess Controls Ltd.	Allpolig	= PCD2 Module		Blatt 1
			Bearb.	KAF					+ PCD2.K551		
			Gepr								
Änderung	Datum	Name	Urspr		Ersatz von	Ersetzt durch				Blatt	522

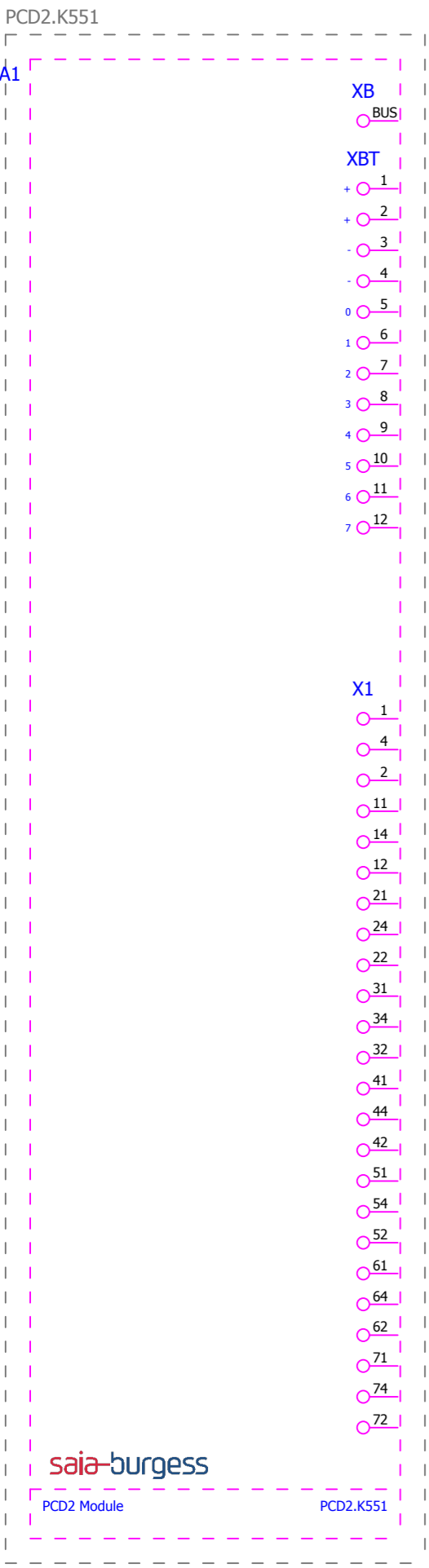

Saia-Burgess\PCD2 Module\PCD2.K551.ema
Overview
Variant A

1 2012-10-26 / 2.1.4			= PCD2 Module		+ PCD2.K551		Blatt 10	
1 2012-10-26 / 2.1.4			= PCD2 Module		+ PCD2.K551		Blatt 522	
Änderung	Datum	Name	Ürspr	Ersatz von	Ersetzt durch			
			Datum	26.10.2012				
			Bearb.	KAF				
			Gepr					
			EPLAN Software & Service		Saia-Burgess Controls Ltd.		SPS-Übersicht	
			EPLAN Saia-Burgess Makroprojekt		Control Systems and Components			
			saia-burgess					

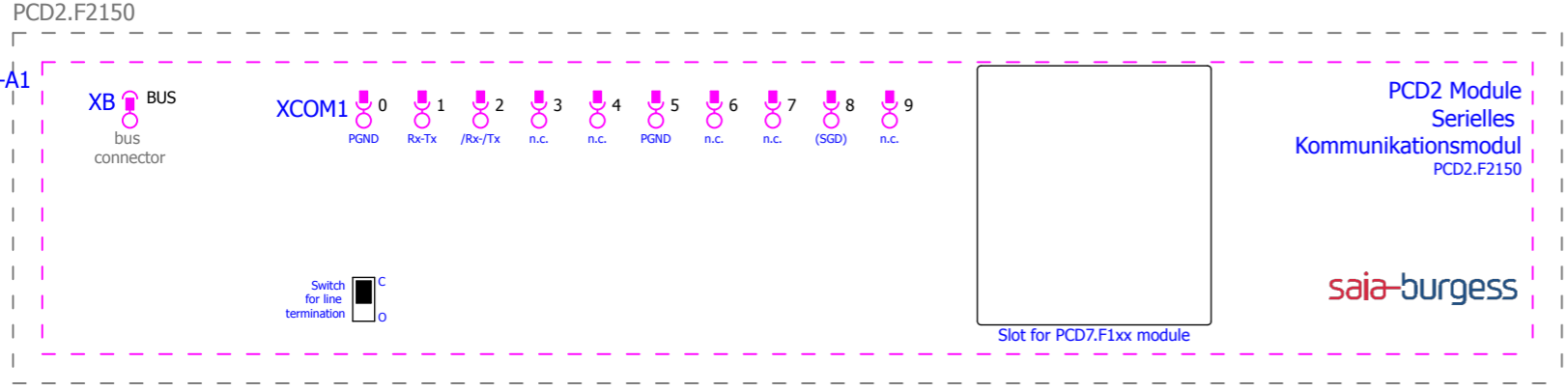

Saia-Burgess\PCD2 Module\PCD2.F2150.ema
 Multi-line
 Variant A
 2012-10-26 / 2.1.4

			Datum	26.10.2012	EPLAN Software & Service Saia-Burgess Makroprojekt	 Control Systems and Components	Saia-Burgess Controls Ltd.	Allpolig	= PCD2 Module		Blatt 1
			Bearb.	KAF					+ PCD2.F2150		
			Gepr								
Änderung	Datum	Name	Urspr		Ersatz von	Ersetzt durch			Blatt	522	

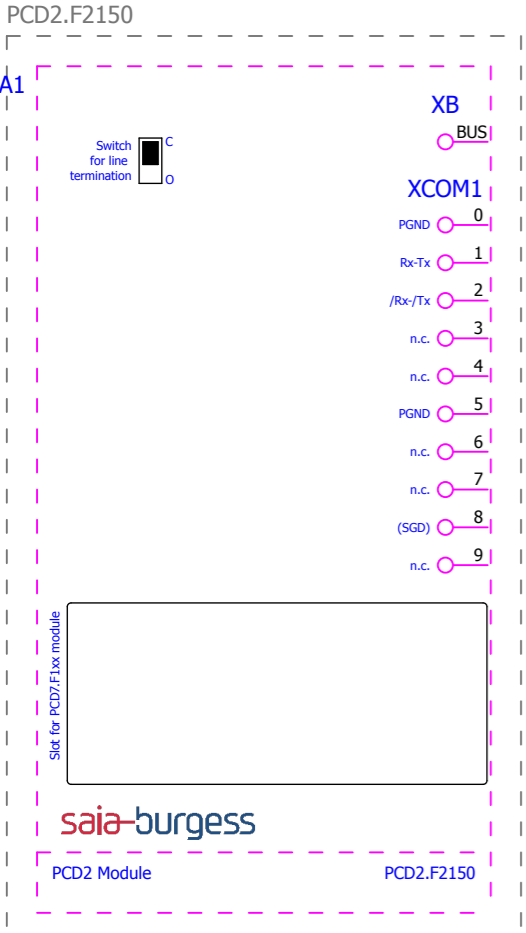

bus connector

Saia-Burgess\PCD2 Module\PCD2.F2150.ema
 Overview
 Variant A
 2012-10-26 / 2.1.4

=PCD2 CPU+.M5440/1

1

			Datum	26.10.2012	EPLAN Software & Service Saia-Burgess Makroprojekt	Saia-Burgess Controls Ltd. Control Systems and Components	Saia-Burgess Controls Ltd.	SPS-Übersicht	= PCD2 Module		Blatt 10
			Bearb.	KAF					+ PCD2.F2150		
			Gepr								
Änderung	Datum	Name	Üspr		Ersatz von	Ersetzt durch			Blatt	522	

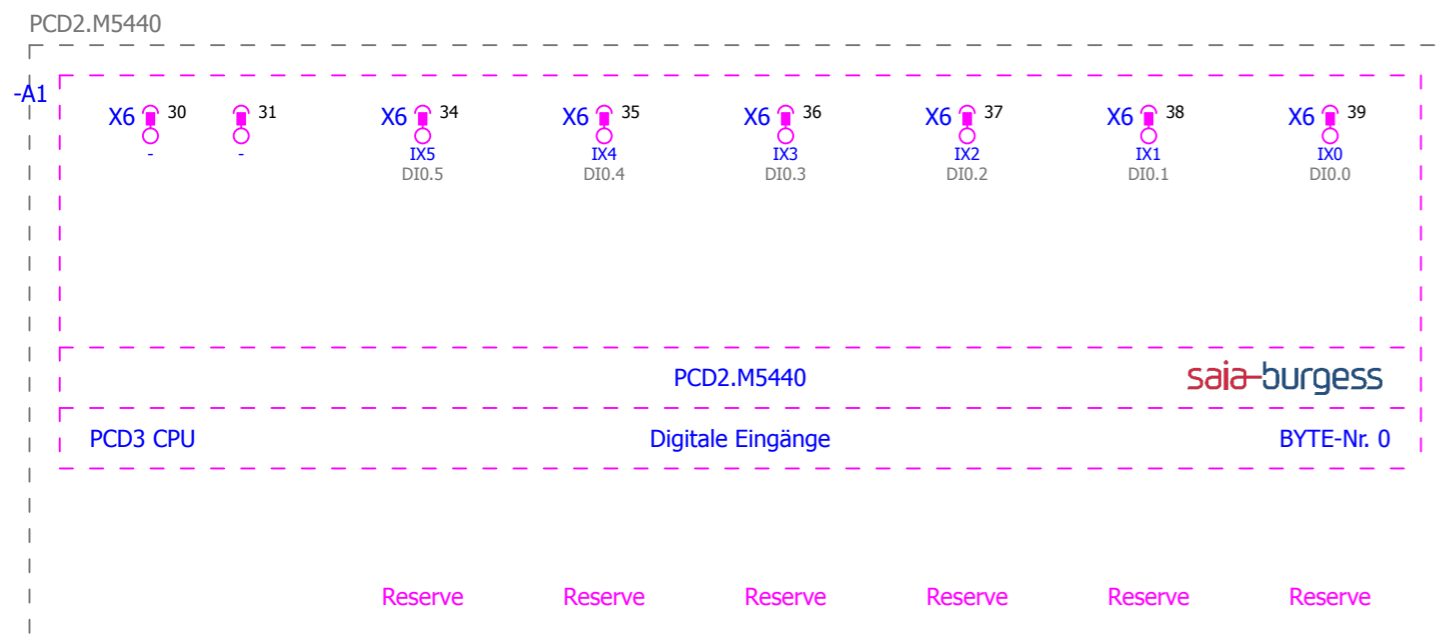

Saia-Burgess\PCD2 CPU\PCD2.M5440.ema
Multi-line
Variant B
2012-10-26 / 2.1.4

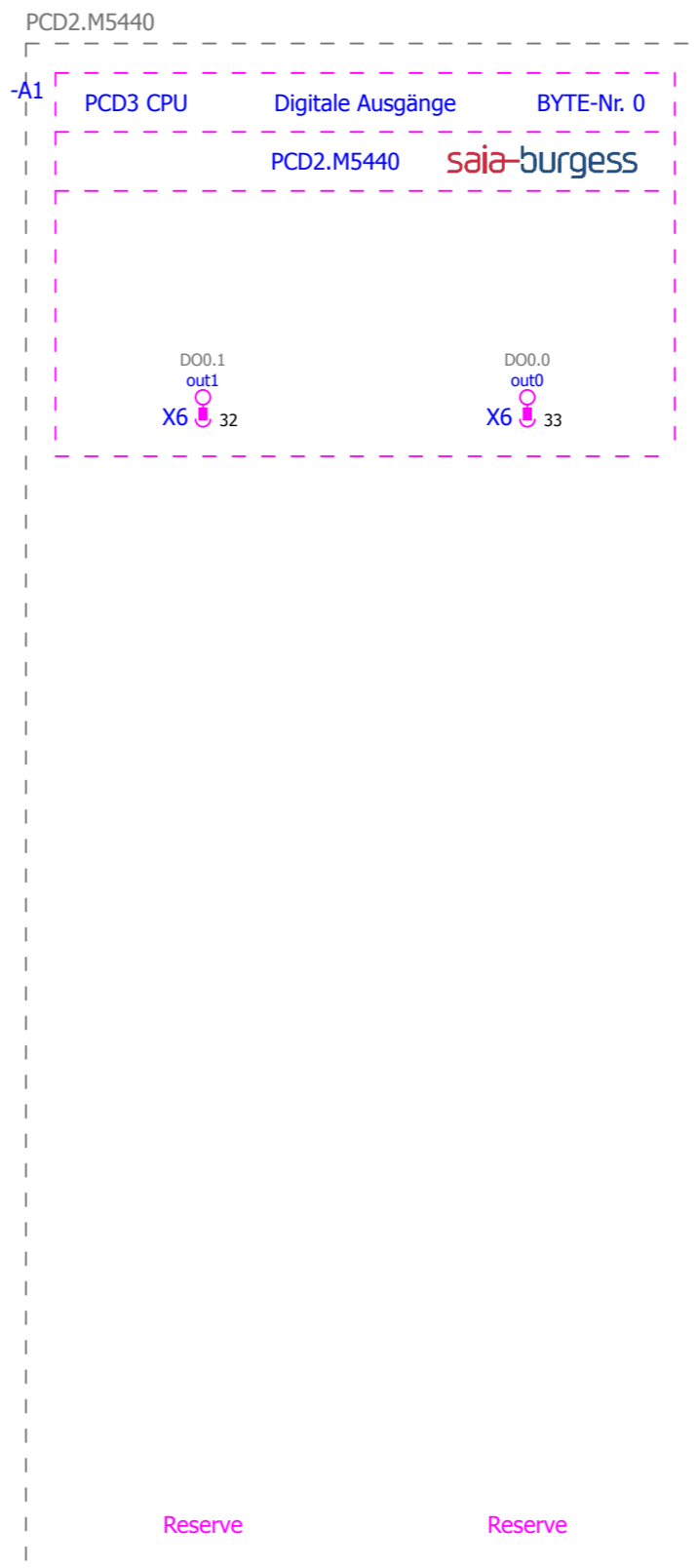

Saia-Burgess\PCD2 CPU\PCD2.M5440.ema
Multi-line
Variant C
2012-10-26 / 2.1.4

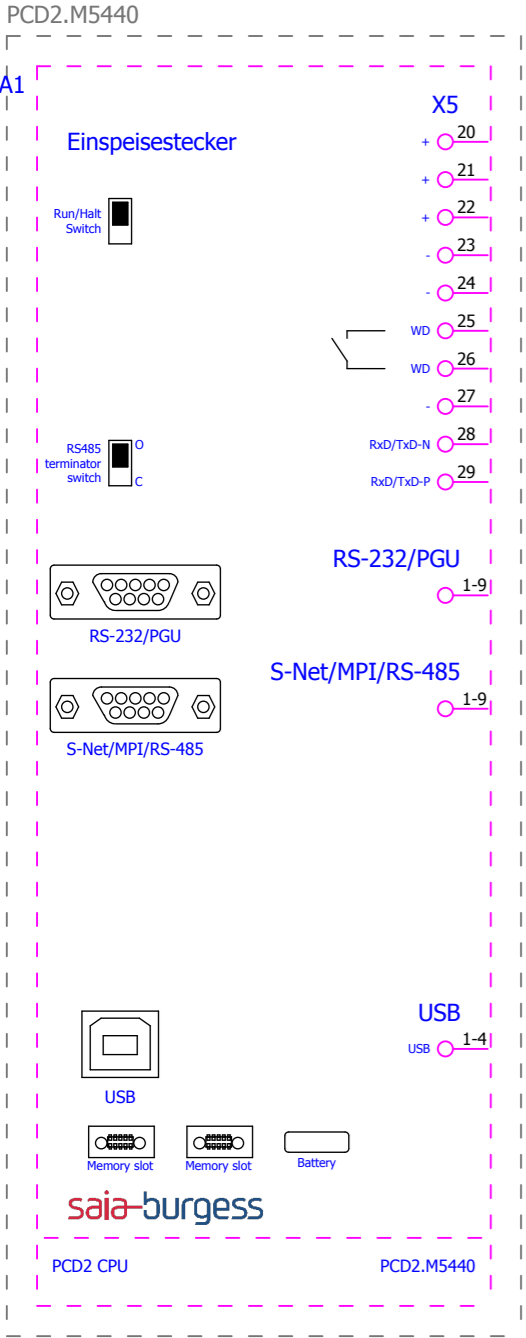

Saia-Burgess\PCD2 CPU\PCD2.M5440.ema
 Overview
 Variant A
 2012-10-26 / 2.1.4

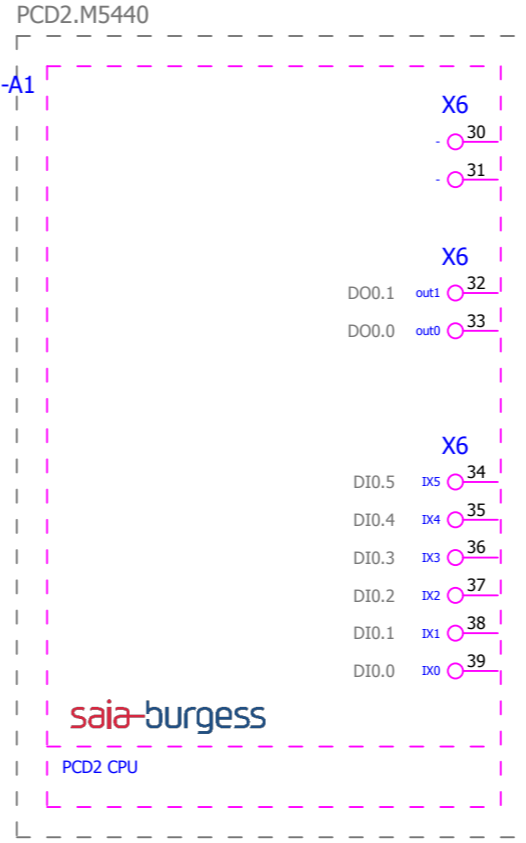

Saia-Burgess\PCD2 CPU\PCD2.M5440.ema
 Overview
 Variant B
 2012-10-26 / 2.1.4

Reserve
 Reserve
 Reserve
 Reserve
 Reserve
 Reserve
 Reserve

			Datum	26.10.2012	EPLAN Software & Service Saia-Burgess Makroprojekt	 Control Systems and Components	Saia-Burgess Controls Ltd.	SPS-Übersicht	= PCD2 CPU		Blatt 10
			Bearb.	KAF			+ PCD2.M5440		Blatt 522		
			Gepr								
Änderung	Datum	Name	Urspr		Ersatz von	Ersetzt durch					

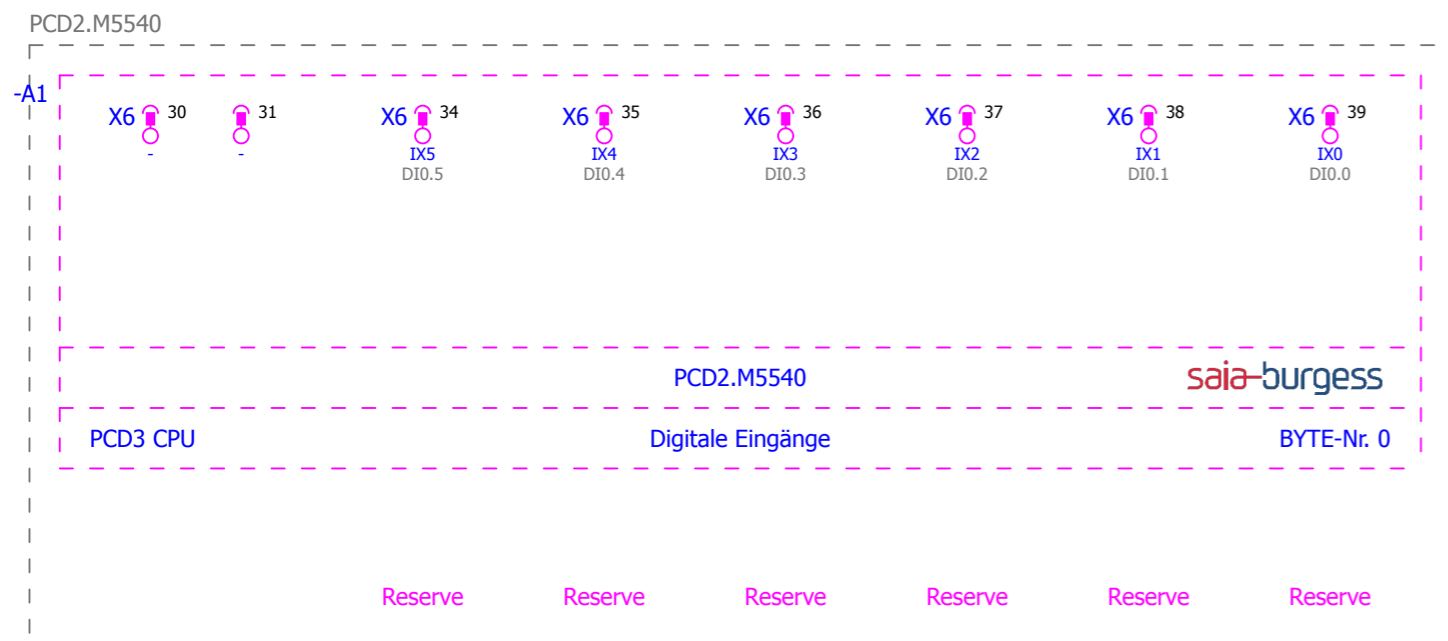

Saia-Burgess\PCD2 CPU\PCD2.M5540.ema
Multi-line
Variant B
2012-10-26 / 2.1.4

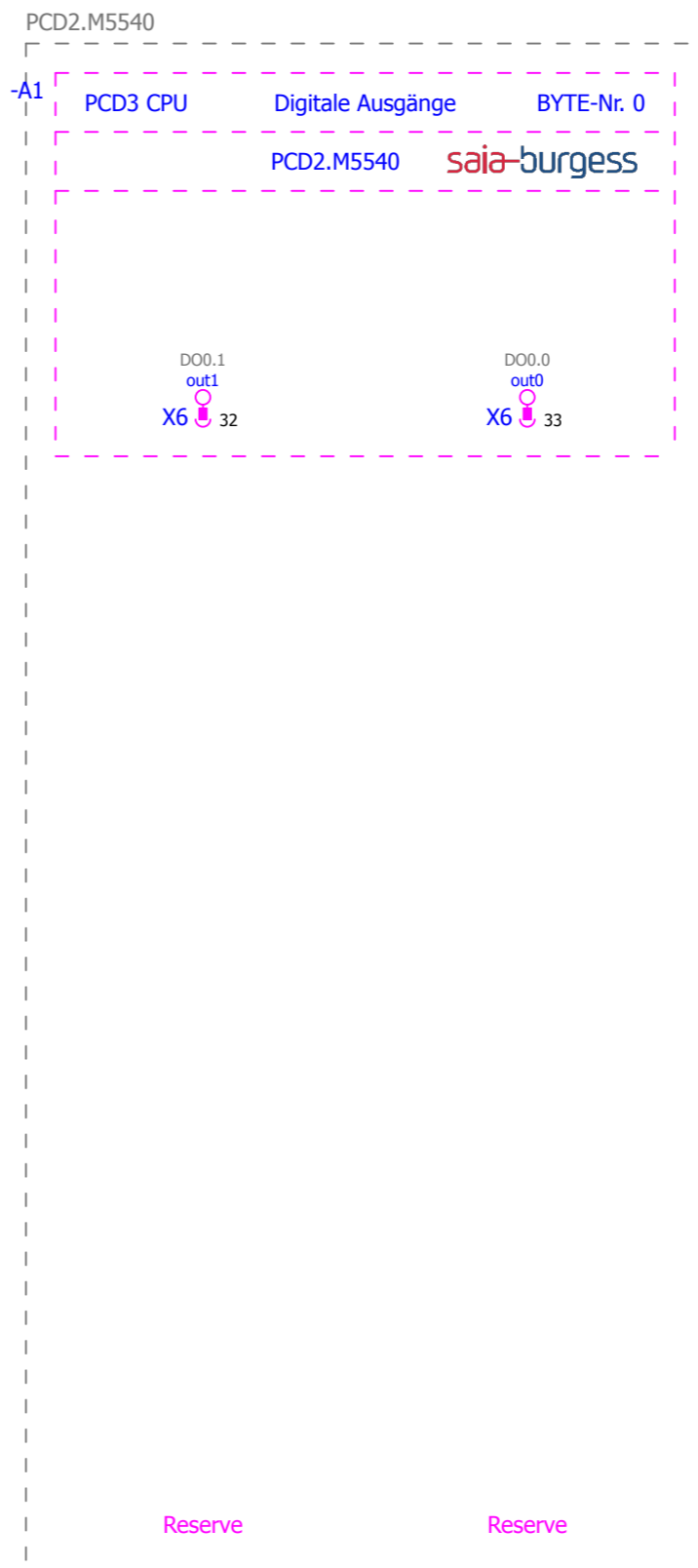

Saia-Burgess\PCD2 CPU\PCD2.M5540.ema
Multi-line
Variant C
2012-10-26 / 2.1.4

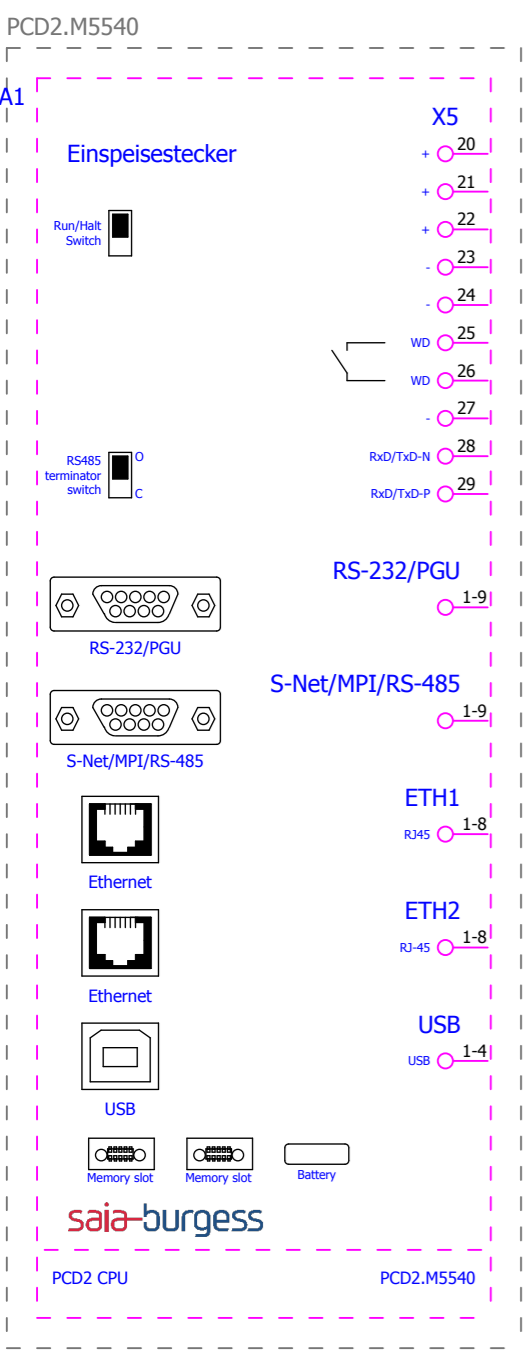

Saia-Burgess\PCD2 CPU\PCD2.M5540.ema
 Overview
 Variant A
 2012-10-26 / 2.1.4

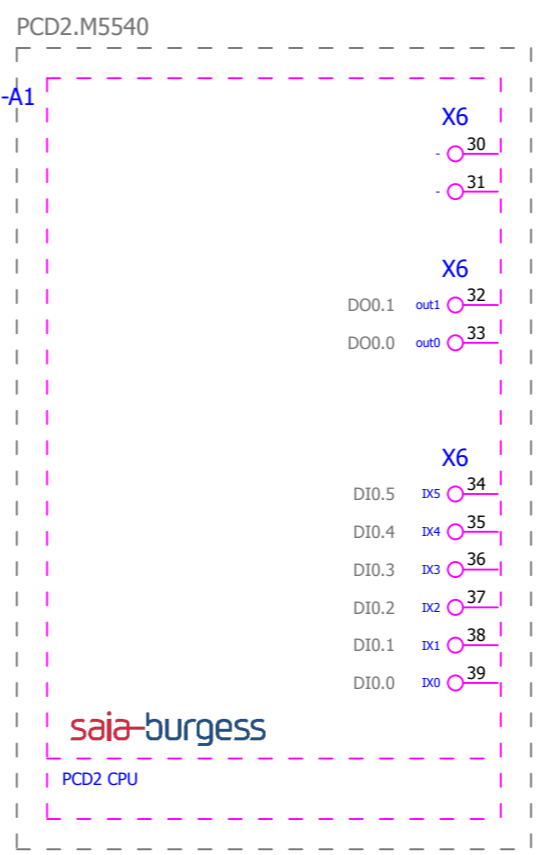

Saia-Burgess\PCD2 CPU\PCD2.M5540.ema
 Overview
 Variant B
 2012-10-26 / 2.1.4

Reserve
 Reserve
 Reserve
 Reserve
 Reserve
 Reserve

			Datum	26.10.2012	EPLAN Software & Service Saia-Burgess Makroprojekt	Saia-Burgess Controls Ltd.	SPS-Übersicht	= PCD2 CPU	
			Bearb.	KAF				+ PCD2.M5540	
			Gepr					Blatt	10
Änderung	Datum	Name	Urspr		Ersatz von	Ersetzt durch		Blatt	522

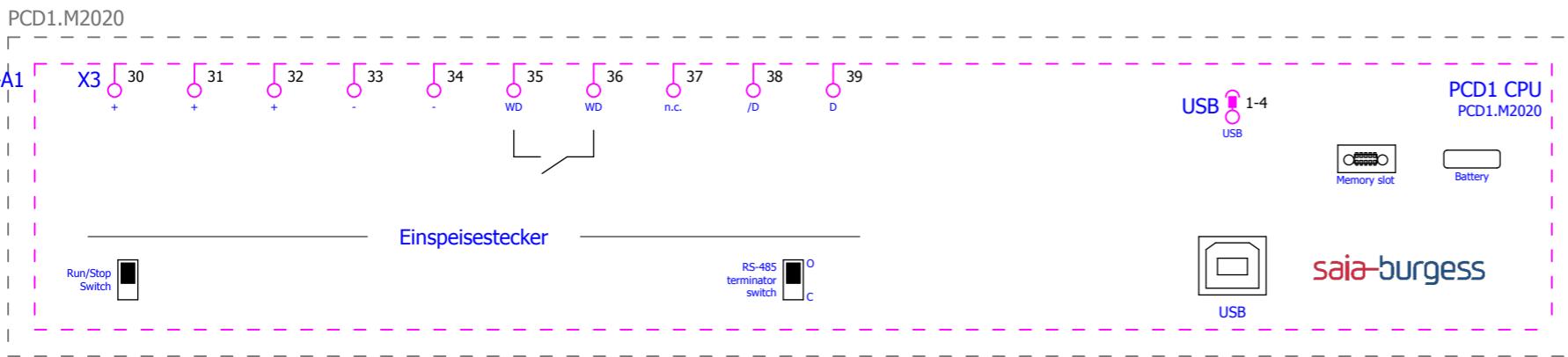

Saia-Burgess\PCD1 CPU\PCD1.M2000.ema
 Multi-line
 Variant A
 2012-10-26 / 2.1.4

=PCD2 CPU+PCD2.M5540/10

			Datum	26.10.2012	EPLAN Software & Service Saia-Burgess Makroprojekt	Saia-Burgess Controls Ltd. <small>Control Systems and Components</small>	Allpolig			= PCD1 CPU	
			Bearb.	KAF						+ PCD1.M2020	
			Gepr								Blatt 1
Änderung	Datum	Name	Urspr		Ersatz von	Ersetzt durch				Blatt 522	

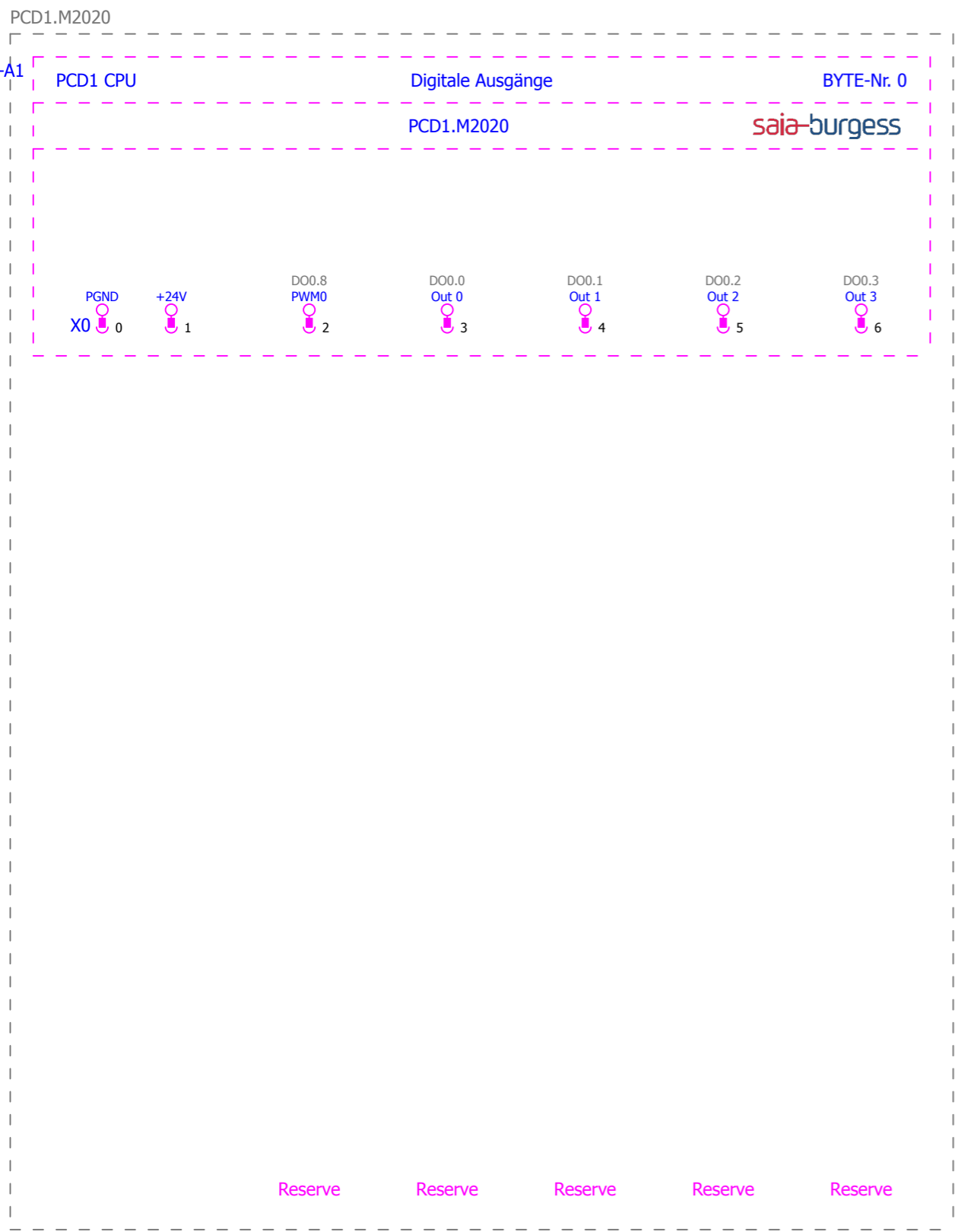

Saia-Burgess\PCD1 CPU\PCD1.M2020.ema
 Multi-line
 Variant B
 2012-10-26 / 2.1.4

		Datum 26.10.2012		EPLAN Software & Service Saia-Burgess Makroprojekt	Saia-Burgess Controls Ltd. <small>Control Systems and Components</small>	Allpolig	= PCD1 CPU		Blatt 2
		Bearb. KAF					+ PCD1.M2020		
		Gepr							
Änderung	Datum	Name	Urspr	Ersatz von	Ersetzt durch			Blatt	522

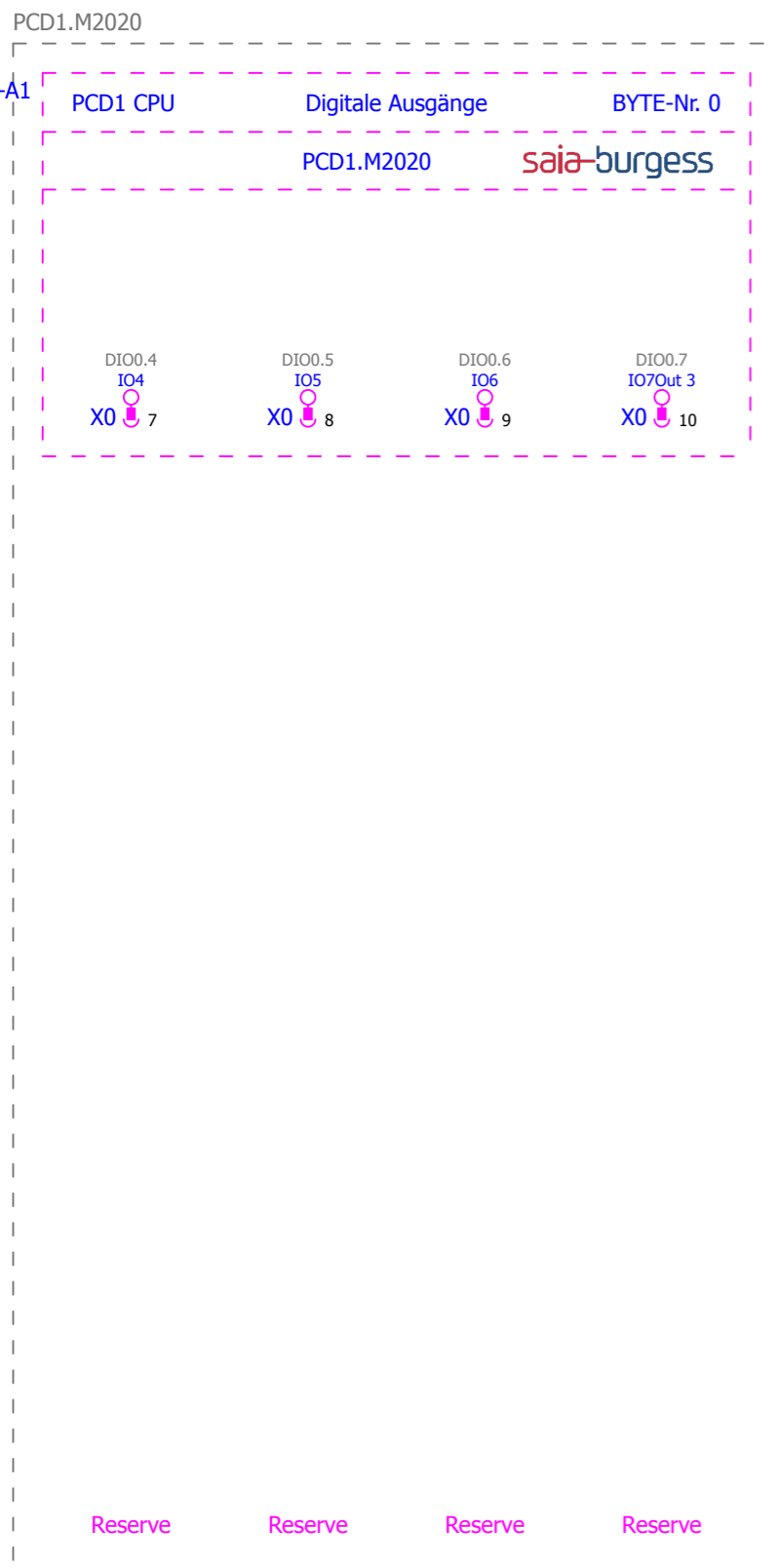

Saia-Burgess\PCD1 CPU\PCD1.M2020.ema
Multi-line
Variant C
2012-10-26 / 2.1.4

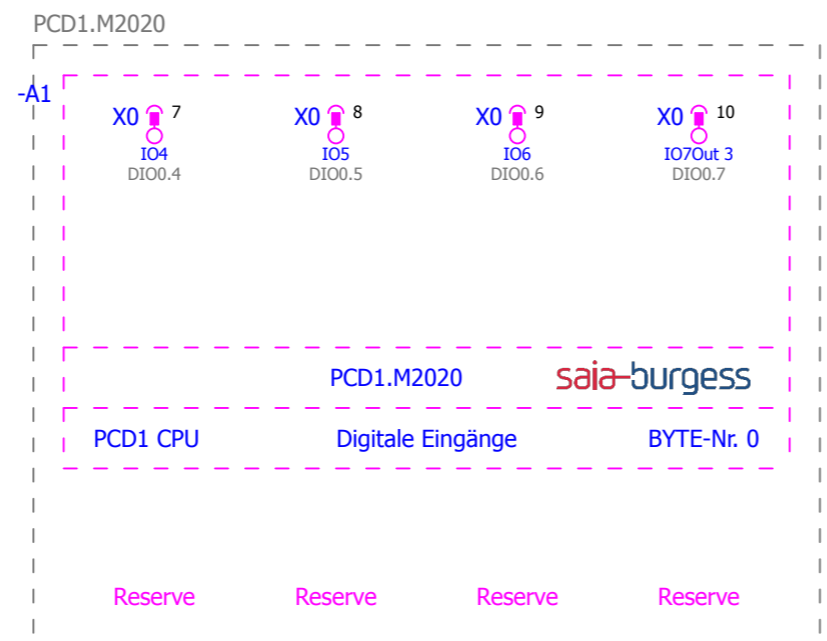

Saia-Burgess\PCD1 CPU\PCD1.M2020.ema
Multi-line
Variant D
2012-10-26 / 2.1.4

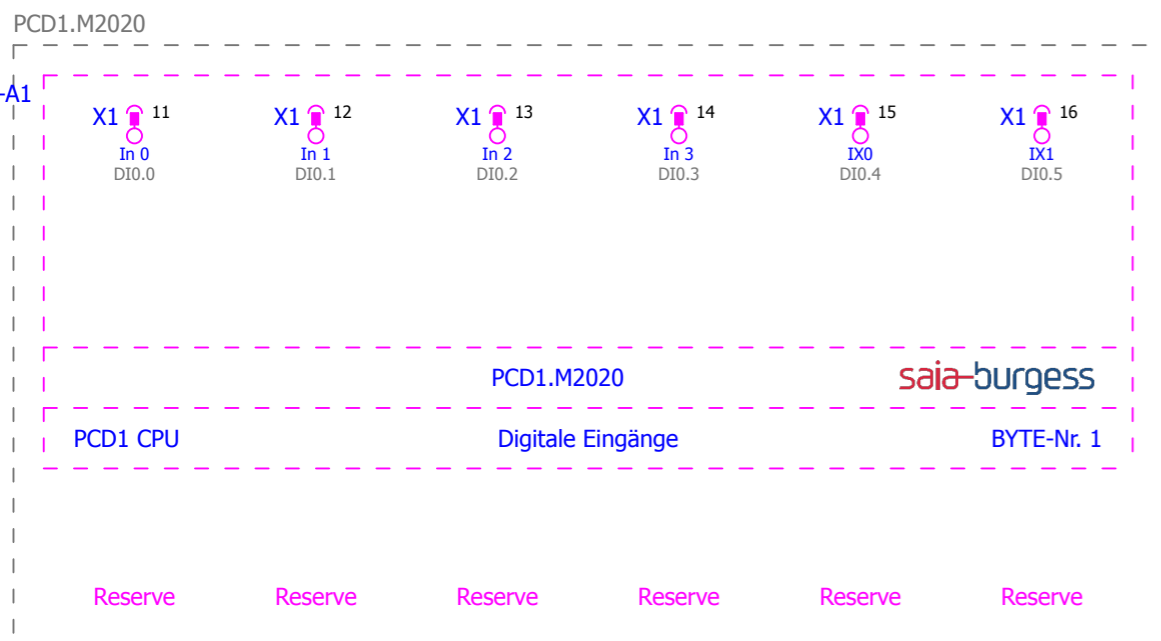

Saia-Burgess\PCD1 CPU\PCD1.M2020.ema
 Multi-line
 Variant E
 2012-10-26 / 2.1.4

			Datum	26.10.2012	EPLAN Software & Service Saia-Burgess Makroprojekt	Saia-Burgess Controls Ltd. <small>Control Systems and Components</small>	Allpolig			= PCD1 CPU	Blatt 4
			Bearb.	KAF						+ PCD1.M2020	
			Gepr								
Änderung	Datum	Name	Urspr		Ersatz von	Ersetzt durch				Blatt 522	

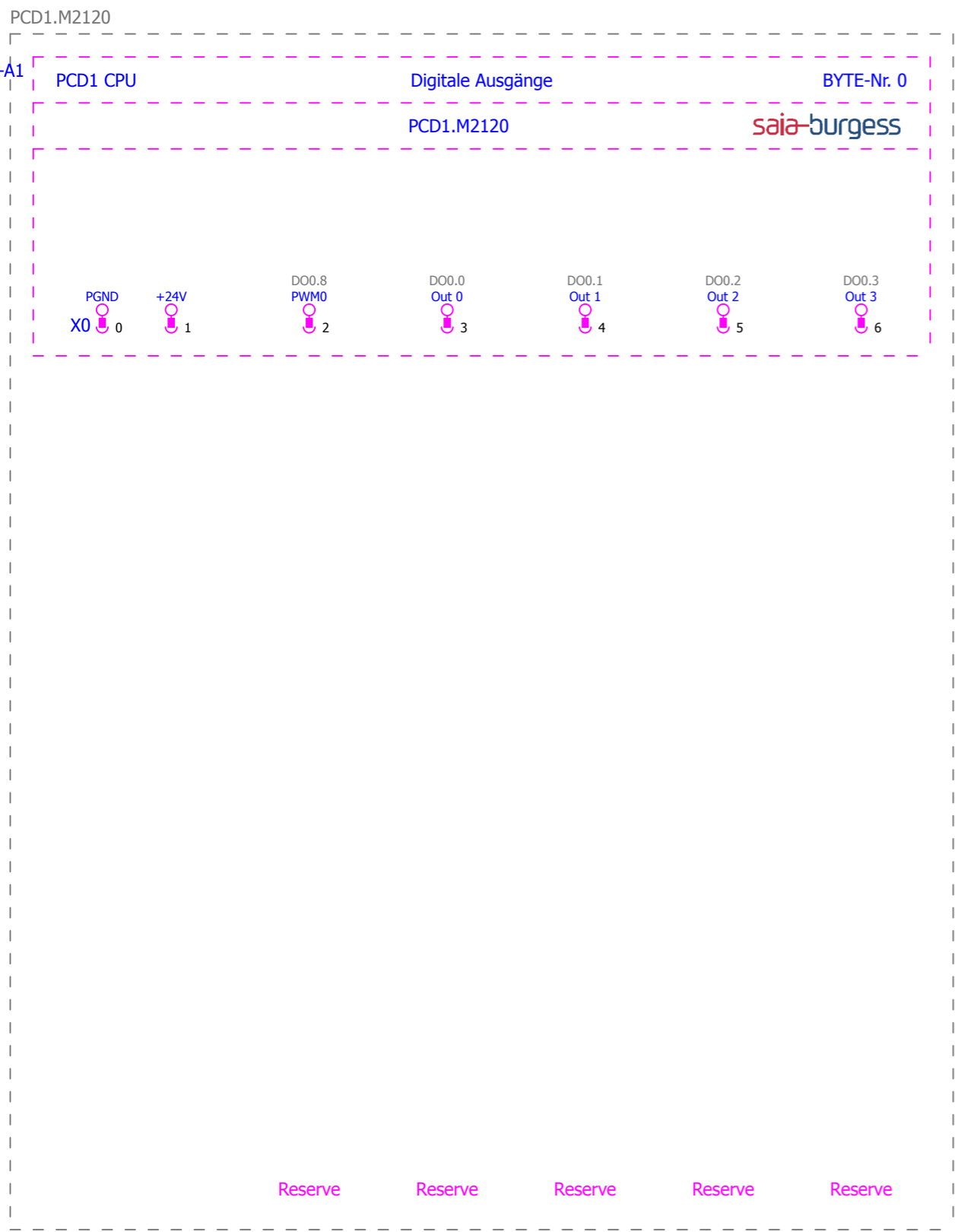

Saia-Burgess\PCD1 CPU\PCD1.M2120.ema
 Multi-line
 Variant B
 2012-10-26 / 2.1.4

		Datum 26.10.2012		EPLAN Software & Service Saia-Burgess Makroprojekt	Saia-Burgess Controls Ltd. <small>Control Systems and Components</small>	Allpolig		= PCD1 CPU	
		Bearb. KAF						+ PCD1.M2120	
		Gepr							
Änderung	Datum	Name	Urspr	Ersatz von	Ersetzt durch			Blatt	2
								Blatt	522

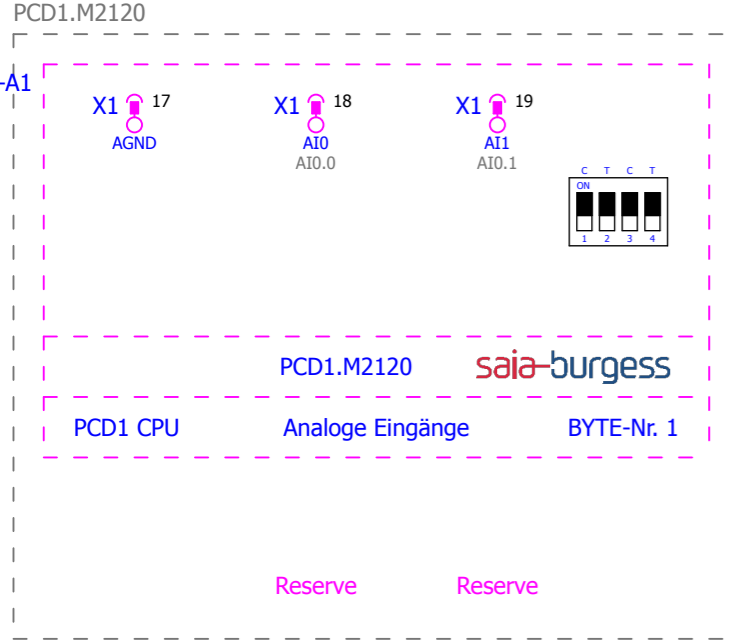

Saia-Burgess\PCD1 CPU\PCD1.M2120.ema
 Multi-line
 Variant F
 2012-10-26 / 2.1.4

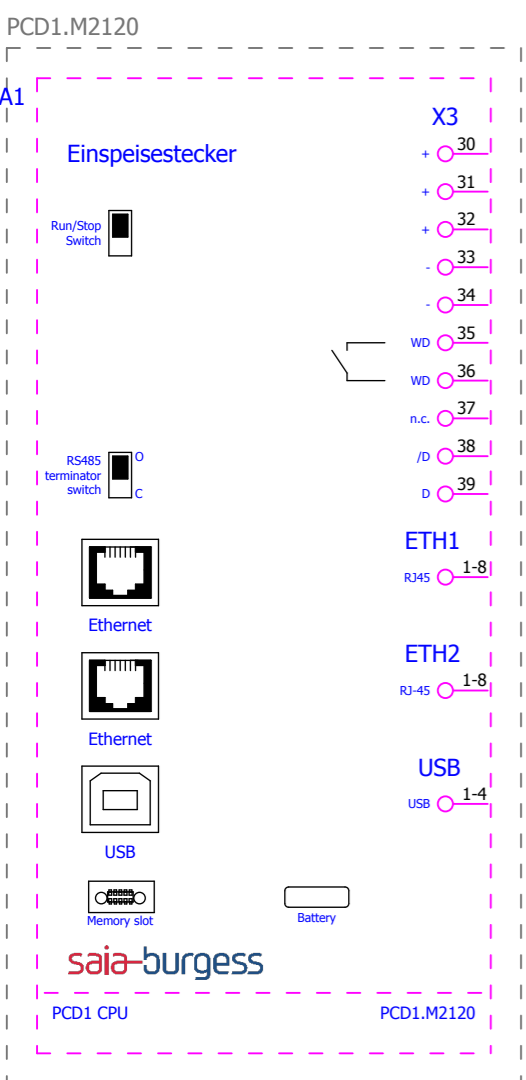

Saia-Burgess\PCD1 CPU\PCD1.M2120.ema
 Overview
 Variant A
 2012-10-26 / 2.1.4

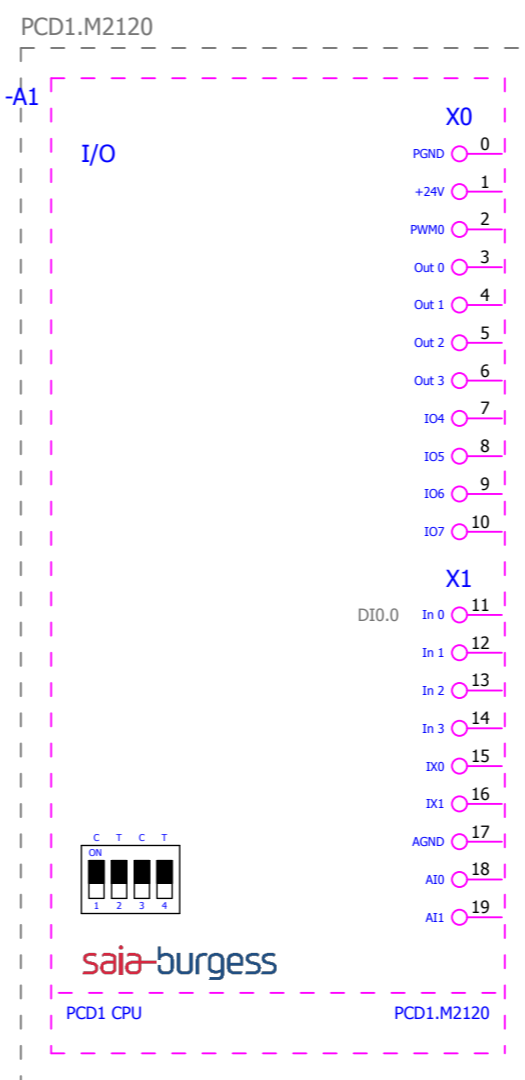

Saia-Burgess\PCD1 CPU\PCD1.M2120.ema
 Overview
 Variant B
 2012-10-26 / 2.1.4

- Reserve
- Reserve
- Reserve
- Reserve
- Reserve
- Reserve
- Reserve
- Reserve
- Reserve
- Reserve
- Reserve
- Reserve
- Reserve
- Reserve
- Reserve
- Reserve
- Reserve
- Reserve
- Reserve

			Datum	26.10.2012	EPLAN Software & Service Saia-Burgess Makroprojekt	Saia-Burgess Controls Ltd. Control Systems and Components	Saia-Burgess Controls Ltd.	SPS-Übersicht			= PCD1 CPU
			Bearb.	KAF					+ PCD1.M2120		
			Gepr								
Änderung	Datum	Name	Urspr	Ersatz von	Ersetzt durch				Blatt	10	
										Blatt	522

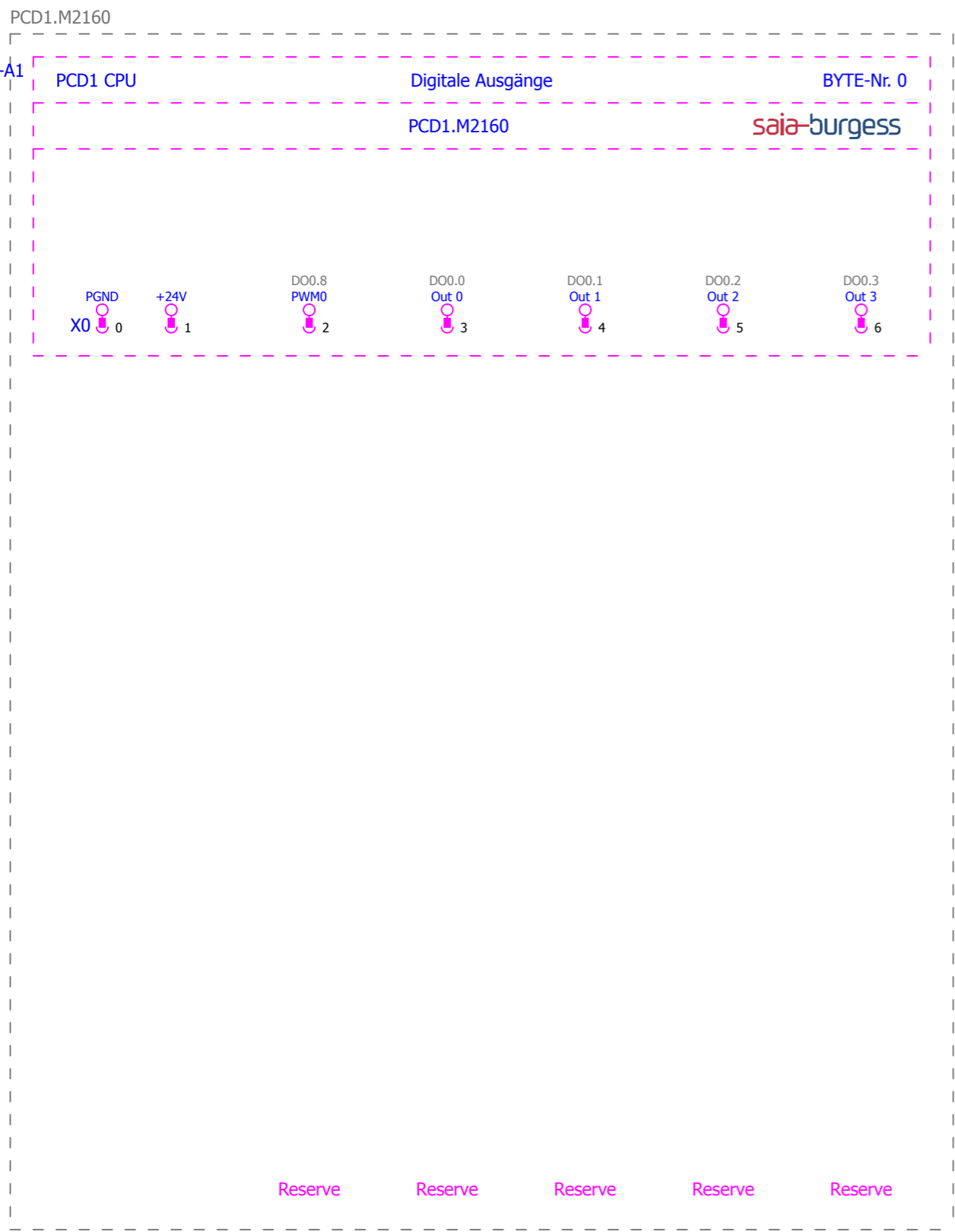

Saia-Burgess\PCD1 CPU\PCD1.M2160.ema
 Multi-line
 Variant B
 2012-10-26 / 2.1.4

			Datum	26.10.2012	EPLAN Software & Service Saia-Burgess Makroprojekt	Saia-Burgess Controls Ltd. <small>Control Systems and Components</small>	Allpolig	= PCD1 CPU	
			Bearb.	KAF				+ PCD1.M2160	
			Gepr					Blatt	2
Änderung	Datum	Name	Urspr		Ersatz von	Ersetzt durch		Blatt	522

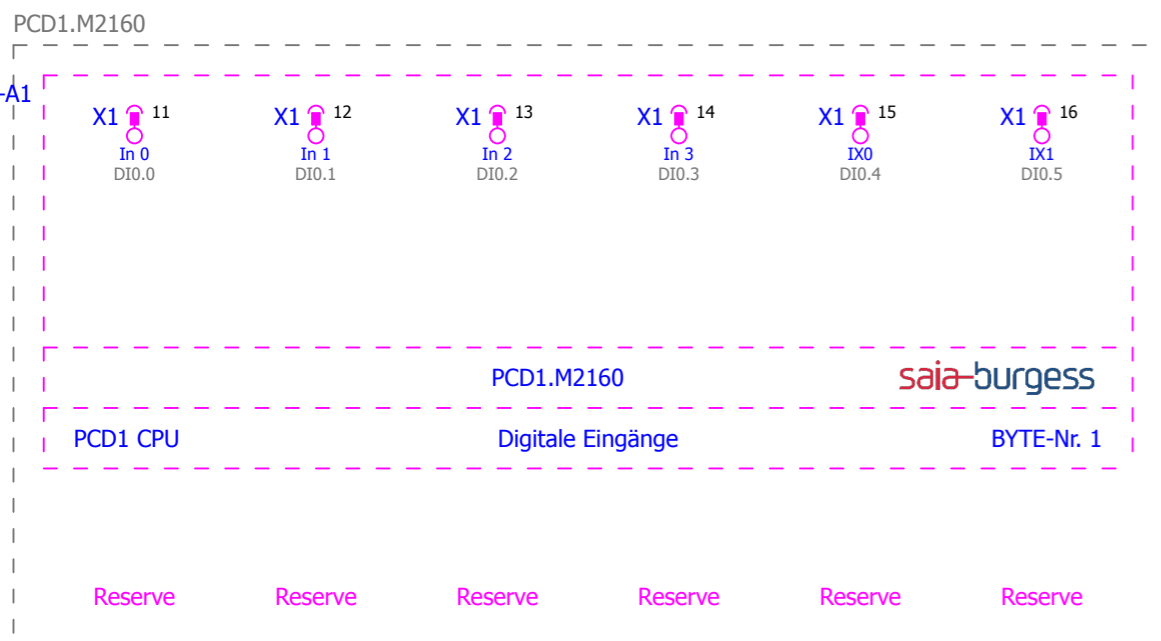

Saia-Burgess\PCD1 CPU\PCD1.M2160.ema
 Multi-line
 Variant E
 2012-10-26 / 2.1.4

			Datum	26.10.2012	EPLAN Software & Service Saia-Burgess Makroprojekt	 Control Systems and Components	Saia-Burgess Controls Ltd.	Allpolig			= PCD1 CPU
			Bearb.	KAF							+ PCD1.M2160
			Gepr								Blatt
Änderung	Datum	Name	Urspr		Ersatz von	Ersetzt durch			Blatt	522	

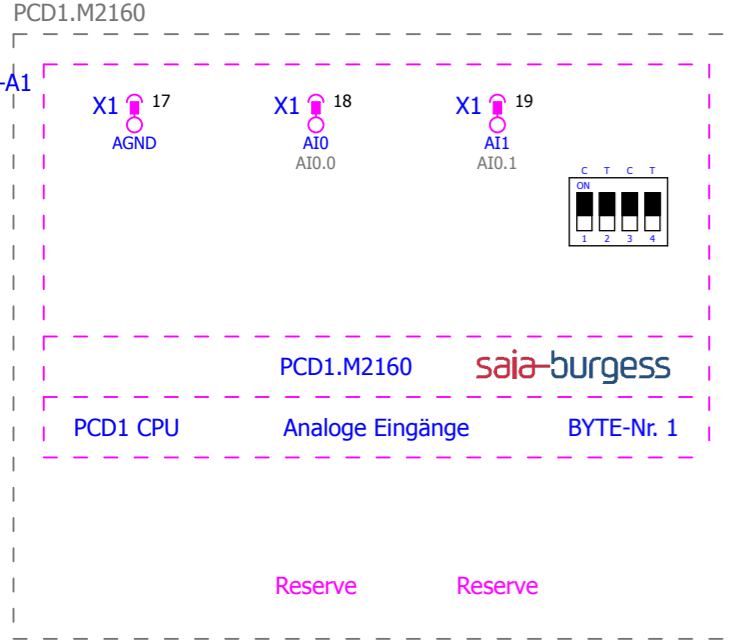

Saia-Burgess\PCD1 CPU\PCD1.M2160.ema
 Multi-line
 Variant F
 2012-10-26 / 2.1.4

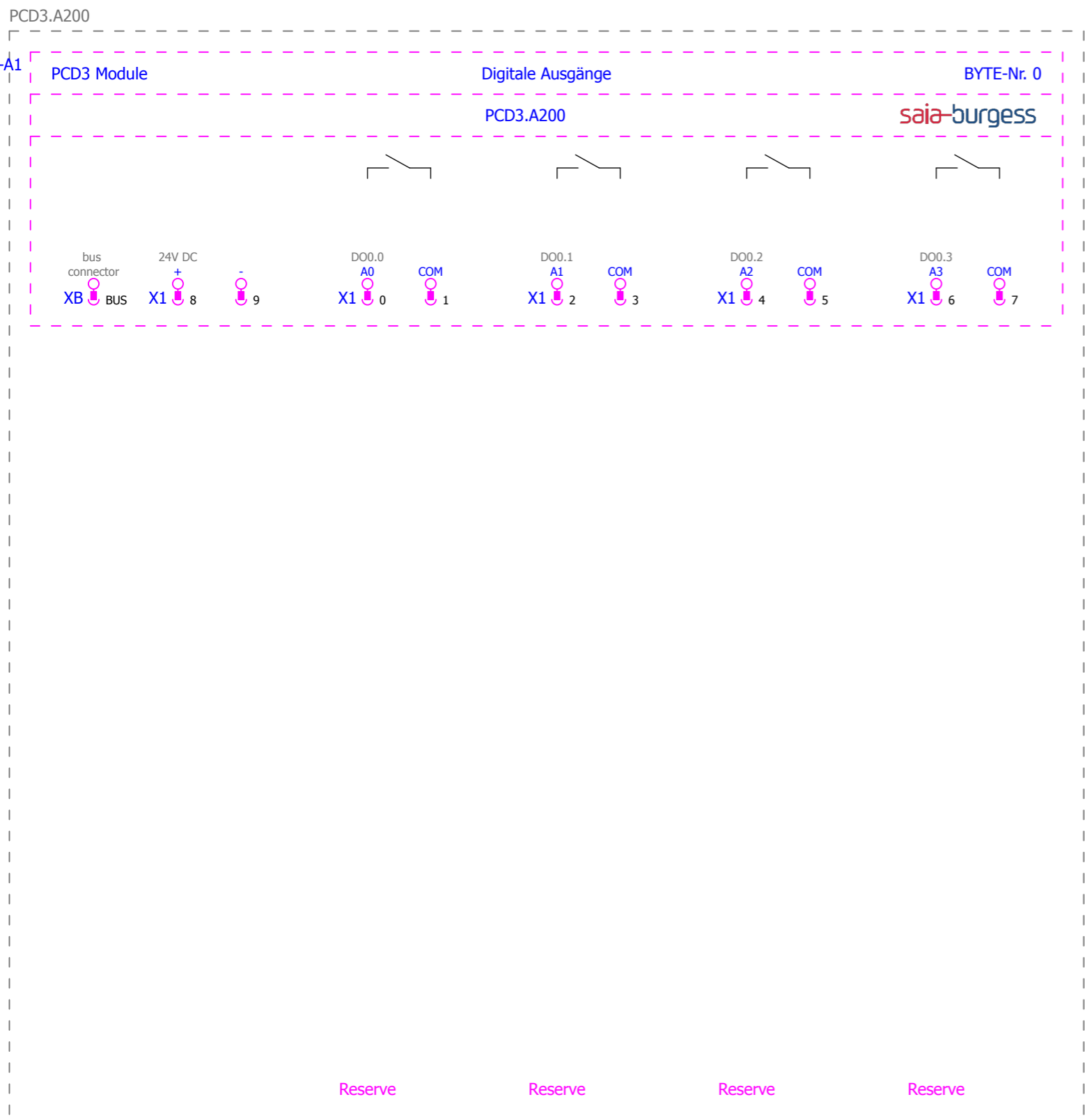

Saia-Burgess\PCD3 Module\PCD3.A200.ema
 Multi-line
 Variant A
 2012-10-26 / 2.1.4
 =PCD1 CPU+PCD1.M2160/10

			Datum	26.10.2012	EPLAN Software & Service Saia-Burgess Makroprojekt	Saia-Burgess Controls Ltd. <small>Control Systems and Components</small>	Allpolig	= PCD3 Module	
			Bearb.	KAF				+ PCD3.A200	
			Gepr					Blatt	1
Änderung	Datum	Name	Urspr	Ersatz von	Ersetzt durch			Blatt	522

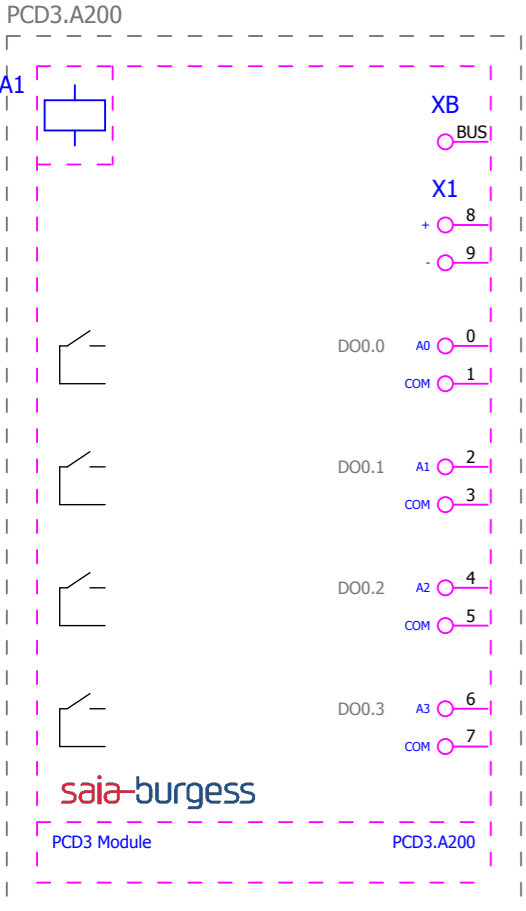

bus connector
 24V DC
 Reserve
 Reserve
 Reserve
 Reserve

Saia-Burgess\PCD3 Module\PCD3.A200.ema
 Overview
 Variant A
 2012-10-26 / 2.1.4

			Datum	26.10.2012	EPLAN Software & Service Saia-Burgess Makroprojekt	Saia-Burgess Controls Ltd. Control Systems and Components	Saia-Burgess Controls Ltd.	SPS-Übersicht	= PCD3 Module		Blatt 10
		Bearb.	KAF	+ PCD3.A200							
		Gepr									
Änderung	Datum	Name	Urspr		Ersatz von	Ersetzt durch				Blatt 522	

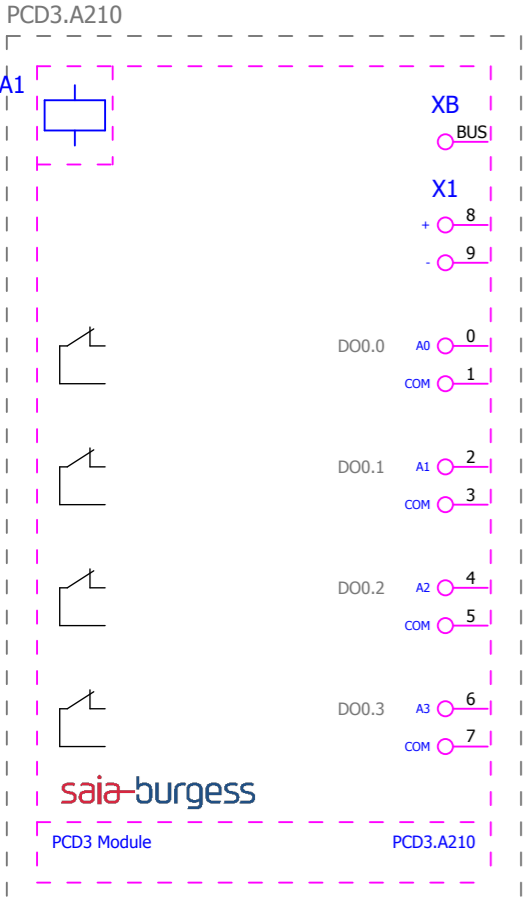

bus connector
 24V DC
 Reserve
 Reserve
 Reserve
 Reserve

Saia-Burgess\PCD3 Module\PCD3.A210.ema
 Overview
 Variant A
 2012-10-26 / 2.1.4

			Datum	26.10.2012	EPLAN Software & Service Saia-Burgess Makroprojekt	Saia-Burgess Controls Ltd. Control Systems and Components	Saia-Burgess Controls Ltd.	SPS-Übersicht	= PCD3 Module		Blatt 10
		Bearb.	KAF	+ PCD3.A210							
		Gepr									
Änderung	Datum	Name	Urspr	Ersatz von	Ersetzt durch					Blatt 522	

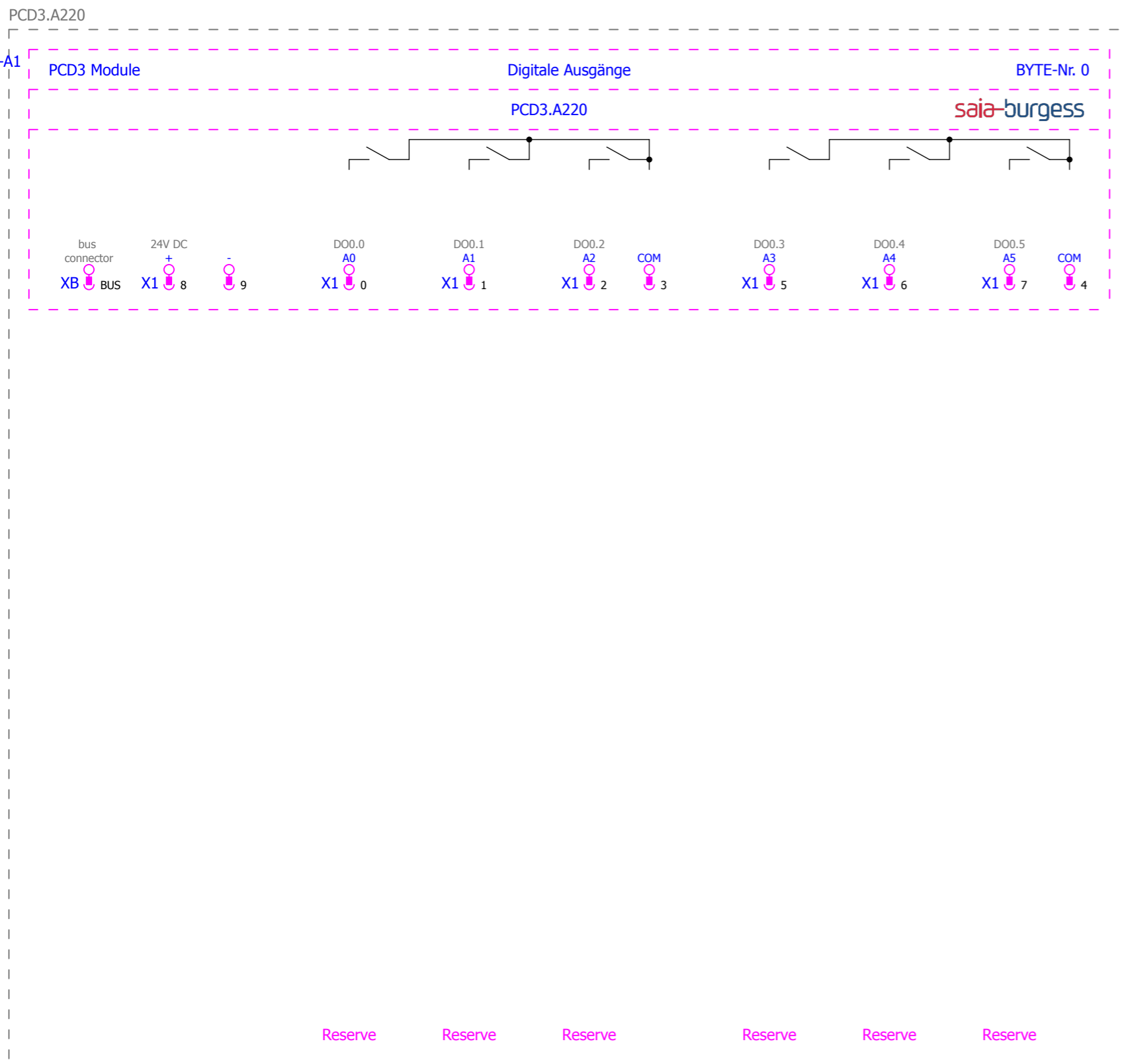

Saia-Burgess\PCD3 Module\PCD3.A220.ema
 Multi-line
 Variant A
 2012-10-26 / 2.1.4



Saia-Burgess\PCD3 Module\PCD3.A220.ema
 Overview
 Variant A
 2012-10-26 / 2.1.4

bus connector
 24V DC
 Reserve
 Reserve
 Reserve
 Reserve
 Reserve
 Reserve

			Datum	26.10.2012	EPLAN Software & Service Saia-Burgess Makroprojekt	Saia-Burgess Controls Ltd. Control Systems and Components	Saia-Burgess Controls Ltd.	SPS-Übersicht	= PCD3 Module		Blatt 10
			Bearb.	KAF					+ PCD3.A220		
			Gepr								
Änderung	Datum	Name	Urspr		Ersatz von	Ersetzt durch				Blatt	522

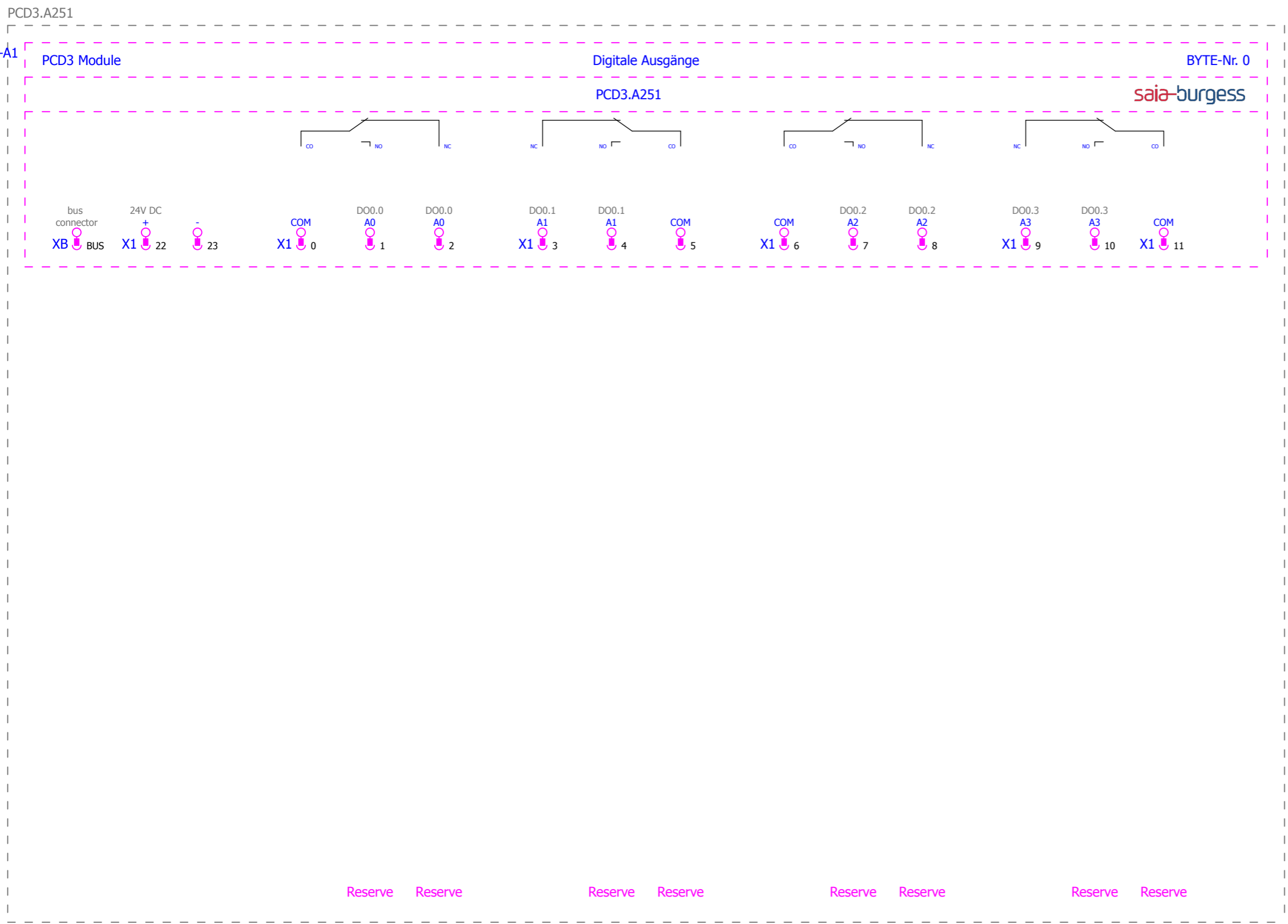

Saia-Burgess\PCD3 Module\PCD3.A251.ema
 Multi-line
 Variant A
 2012-10-26 / 2.1.4

+.A220/10			Datum	26.10.2012	EPLAN Software & Service Saia-Burgess Makroprojekt	Saia-Burgess Controls Ltd. Control Systems and Components	Saia-Burgess Controls Ltd.	Allpolig	= PCD3 Module	
			Bearb.	KAF					+ PCD3.A251	
			Gepr						Blatt	1
Änderung	Datum	Name	Urspr	Ersatz von	Ersetzt durch				Blatt	522

PCD3.A251



Saia-Burgess\PCD3 Module\PCD3.A251.ema
 Multi-line
 Variant B
 2012-10-26 / 2.1.4

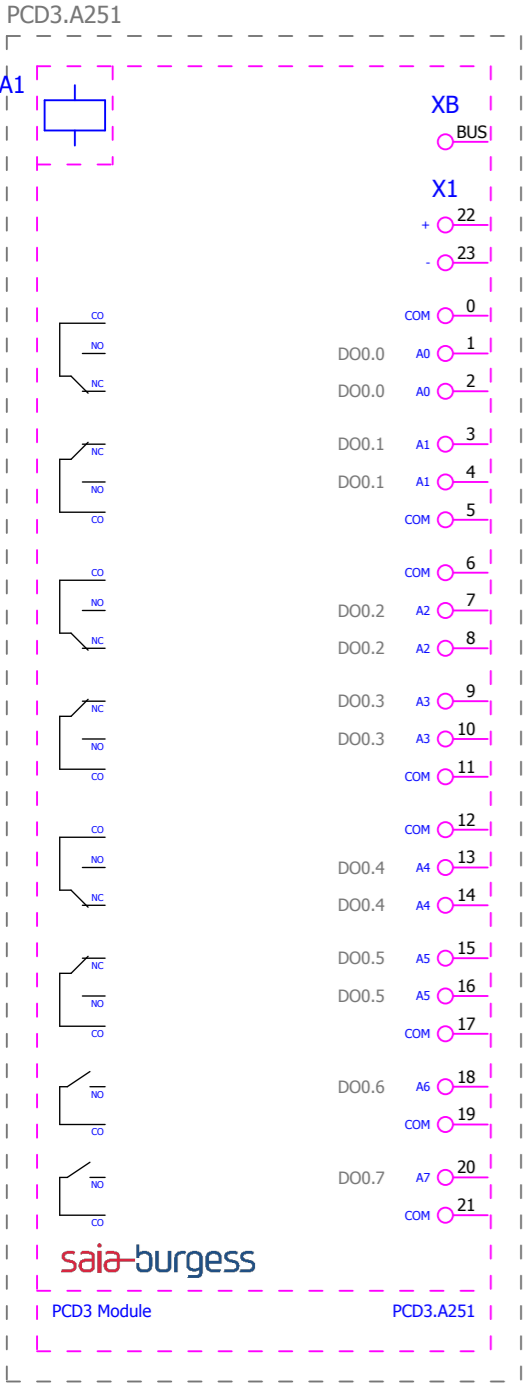

bus connector
 24V DC
 Reserve
 Reserve
 Reserve
 Reserve
 Reserve
 Reserve
 Reserve
 Reserve
 Reserve
 Reserve
 Reserve
 Reserve
 Reserve
 Reserve
 Reserve
 Reserve
 Reserve

Saia-Burgess\PCD3 Module\PCD3.A251.ema
 Overview
 Variant A
 2012-10-26 / 2.1.4

			Datum	26.10.2012	EPLAN Software & Service Saia-Burgess Makroprojekt	Saia-Burgess Controls Ltd. Control Systems and Components	Saia-Burgess Controls Ltd.	SPS-Übersicht	= PCD3 Module		Blatt 10	
			Bearb.	KAF					+ PCD3.A251			Blatt 522
			Gepr									
Änderung	Datum	Name	Urspr		Ersatz von	Ersetzt durch						

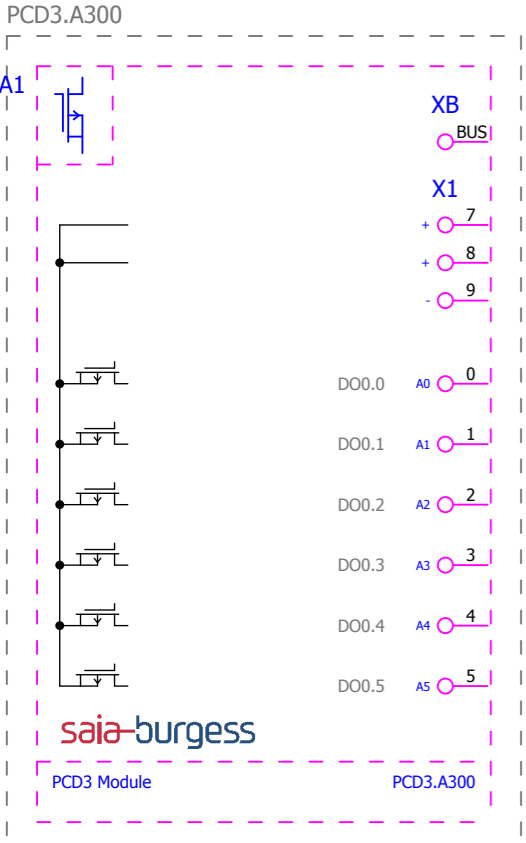

bus connector
 24V DC
 24V DC
 Reserve
 Reserve
 Reserve
 Reserve
 Reserve
 Reserve

Saia-Burgess\PCD3 Module\PCD3.A300.ema
 Overview
 Variant A
 2012-10-26 / 2.1.4

			Datum	26.10.2012	EPLAN Software & Service Saia-Burgess Makroprojekt	Saia-Burgess Controls Ltd. Control Systems and Components	Saia-Burgess Controls Ltd.	SPS-Übersicht	= PCD3 Module		Blatt 10
		Bearb.	KAF	+ PCD3.A300							
		Gepr									
Änderung	Datum	Name	Urspr		Ersatz von	Ersetzt durch				Blatt	522

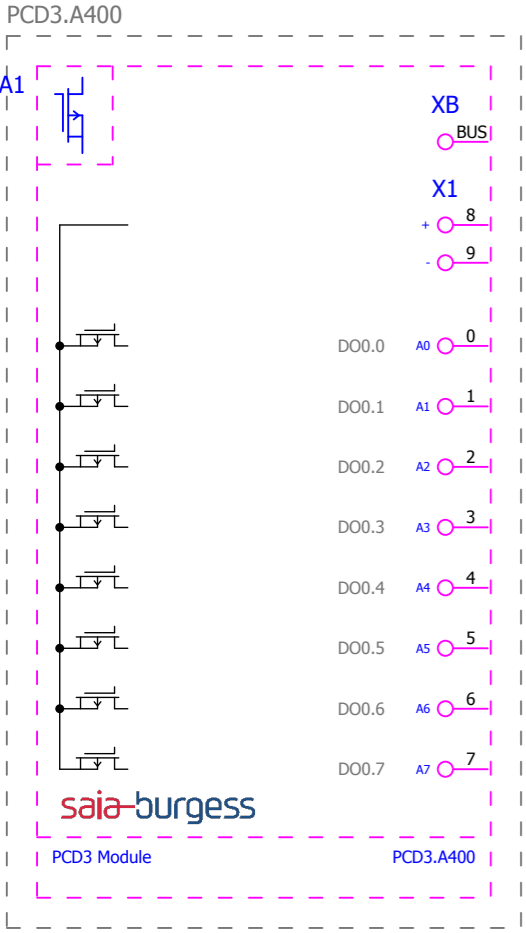

Saia-Burgess\PCD3 Module\PCD3.A400.ema
 Overview
 Variant A
 2012-10-26 / 2.1.4

- bus connector
- 24V DC
- Reserve
- Reserve
- Reserve
- Reserve
- Reserve
- Reserve
- Reserve
- Reserve

			Datum	26.10.2012	EPLAN Software & Service Saia-Burgess Makroprojekt	Saia-Burgess Controls Ltd. Control Systems and Components	Saia-Burgess Controls Ltd.	SPS-Übersicht	= PCD3 Module		Blatt 10
			Bearb.	KAF					+ PCD3.A400		
			Gepr								
Änderung	Datum	Name	Urspr		Ersatz von	Ersetzt durch			Blatt 522		

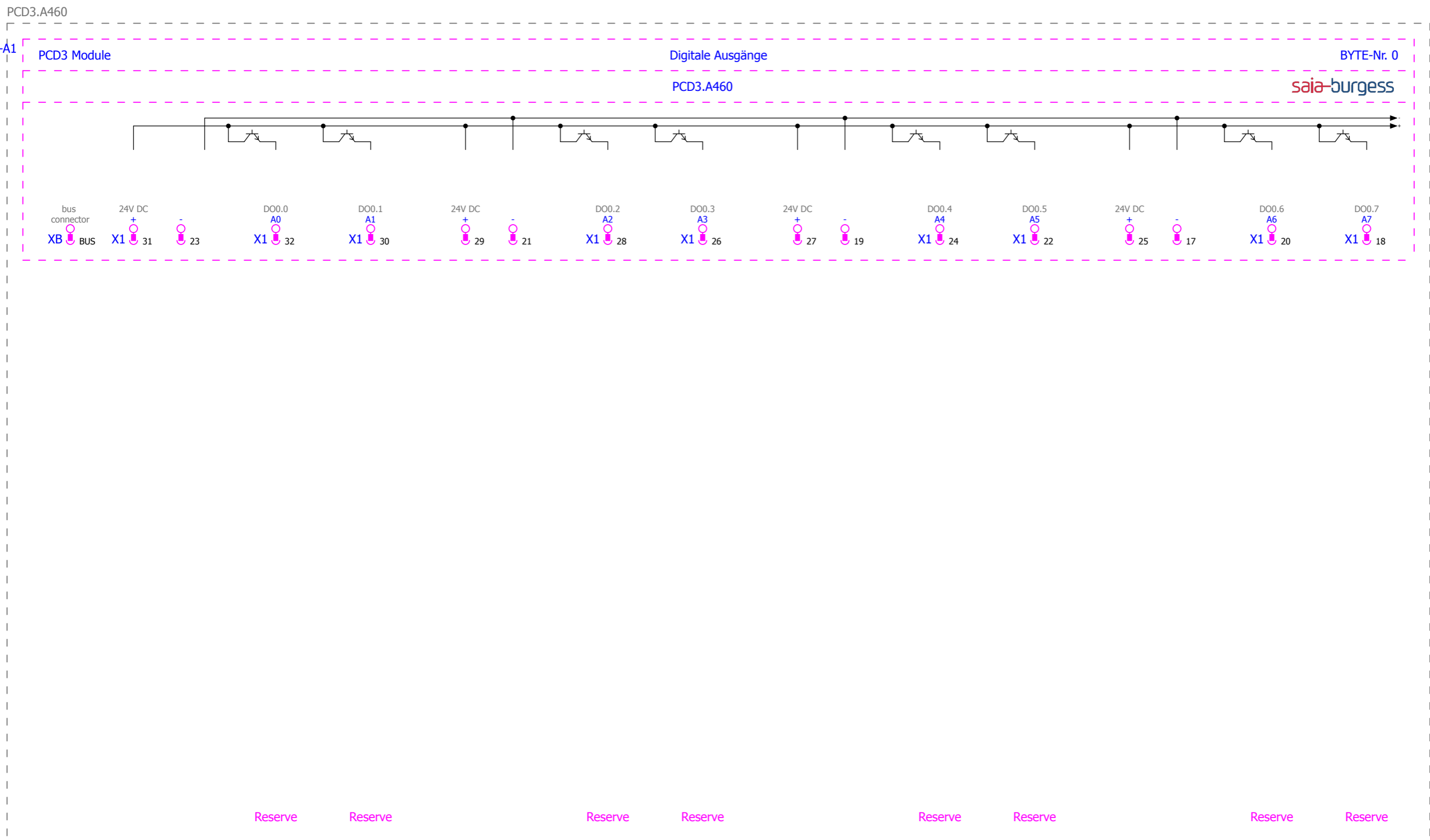

Saia-Burgess\PCD3 Module\PCD3.A460.ema
 Multi-line
 Variant A
 2012-10-26 / 2.1.4

+.A400/10

			Datum	26.10.2012	EPLAN Software & Service Saia-Burgess Makroprojekt	Saia-Burgess Controls Ltd. <small>Control Systems and Components</small>	Allpolig		= PCD3 Module	Blatt 1
		Bearb.	KAF	+ PCD3.A460					Blatt 522	
Änderung	Datum	Name	Urspr	Ersatz von						

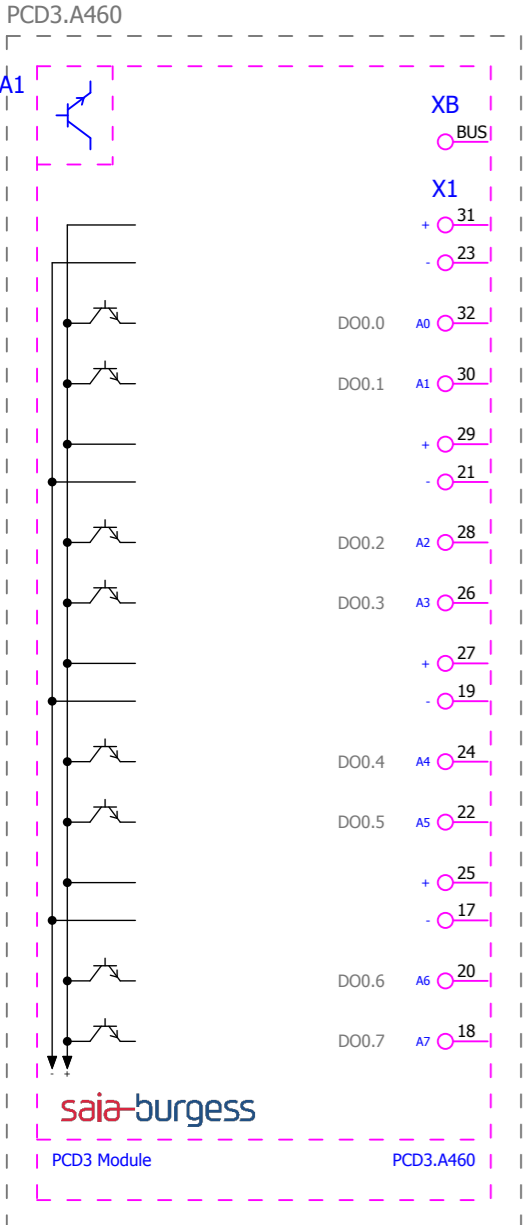

Saia-Burgess\PCD3 Module\PCD3.A460.ema
 Overview
 Variant A
 2012-10-26 / 2.1.4

- bus connector
- 24V DC
- Reserve
- Reserve
- 24V DC
- Reserve
- Reserve
- 24V DC
- Reserve
- Reserve
- 24V DC
- Reserve
- Reserve
- 24V DC
- Reserve
- Reserve

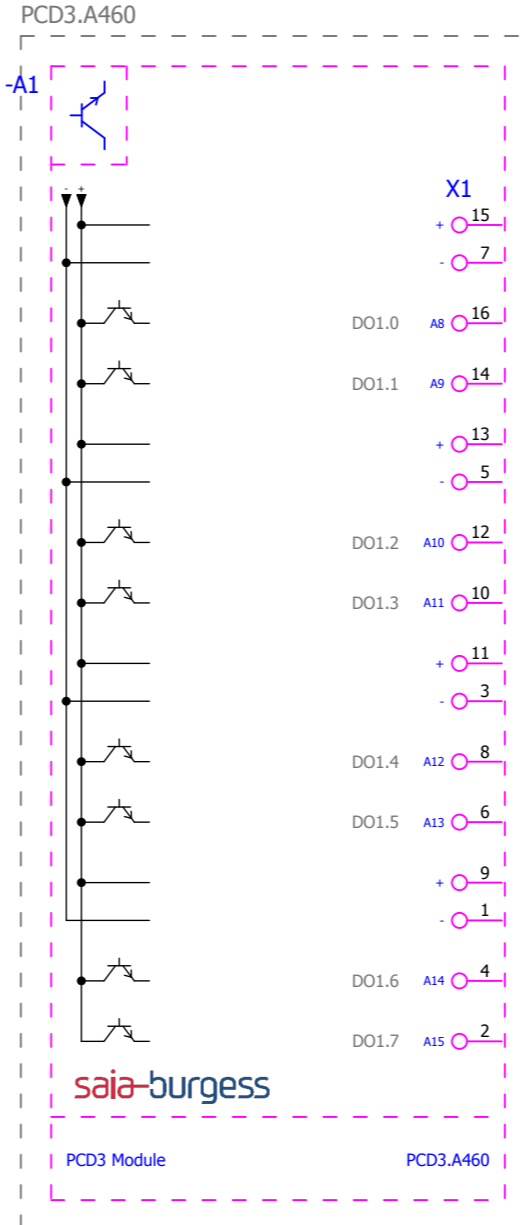

Saia-Burgess\PCD3 Module\PCD3.A460.ema
 Overview
 Variant B
 2012-10-26 / 2.1.4

- 24V DC
- Reserve
- Reserve
- 24V DC
- Reserve
- Reserve
- 24V DC
- Reserve
- Reserve
- 24V DC
- Reserve
- Reserve
- 24V DC
- Reserve
- Reserve

			Datum	26.10.2012	EPLAN Software & Service Saia-Burgess Makroprojekt	Saia-Burgess Controls Ltd. Control Systems and Components	Saia-Burgess Controls Ltd.	SPS-Übersicht	= PCD3 Module		Blatt 10
			Bearb.	KAF					+ PCD3.A460		
			Gepr								
Änderung	Datum	Name	Urspr		Ersatz von	Ersetzt durch				Blatt	522

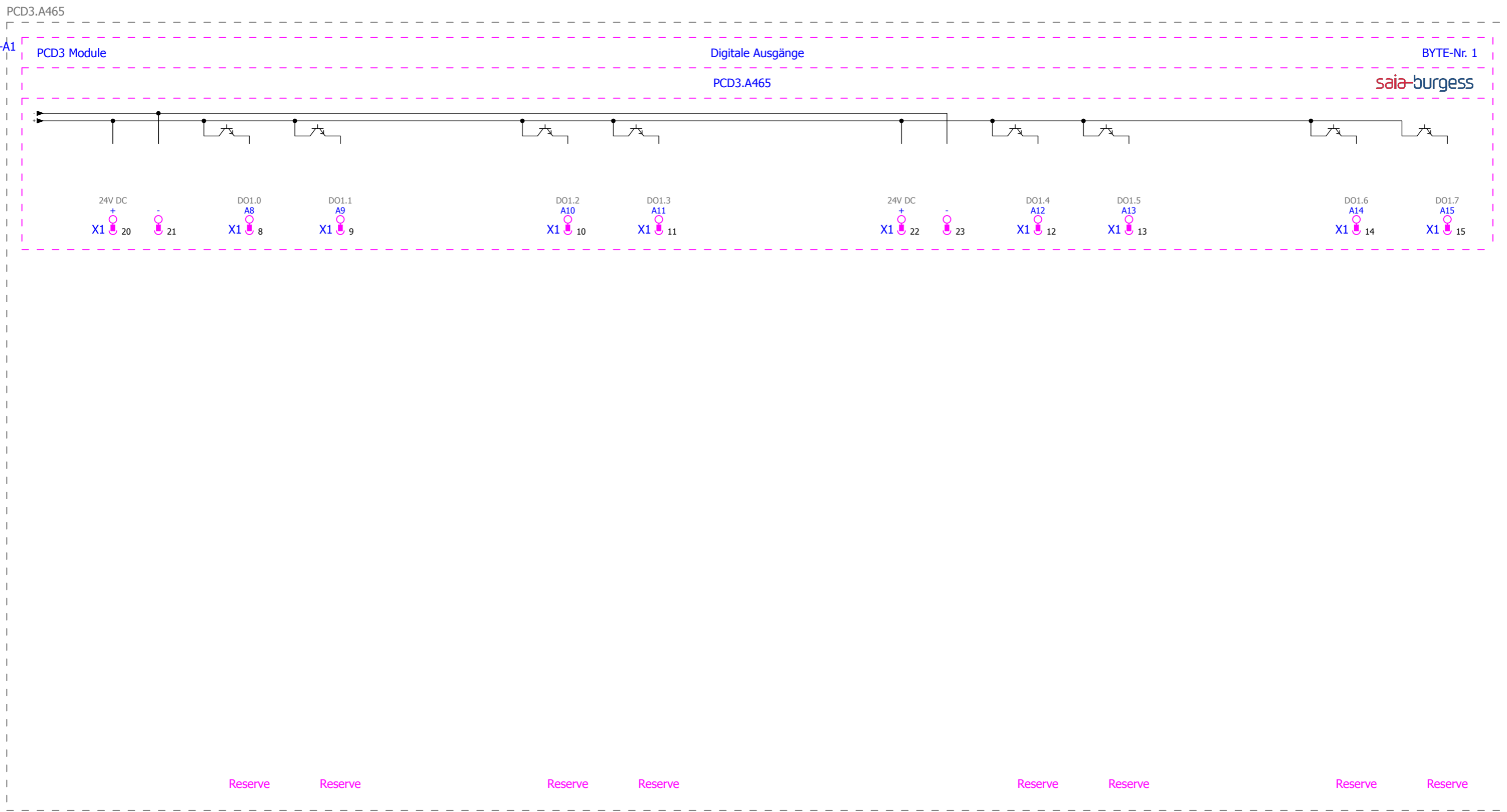

Saia-Burgess\PCD3 Module\PCD3.A465.ema
 Multi-line
 Variant B
 2012-10-26 / 2.1.4

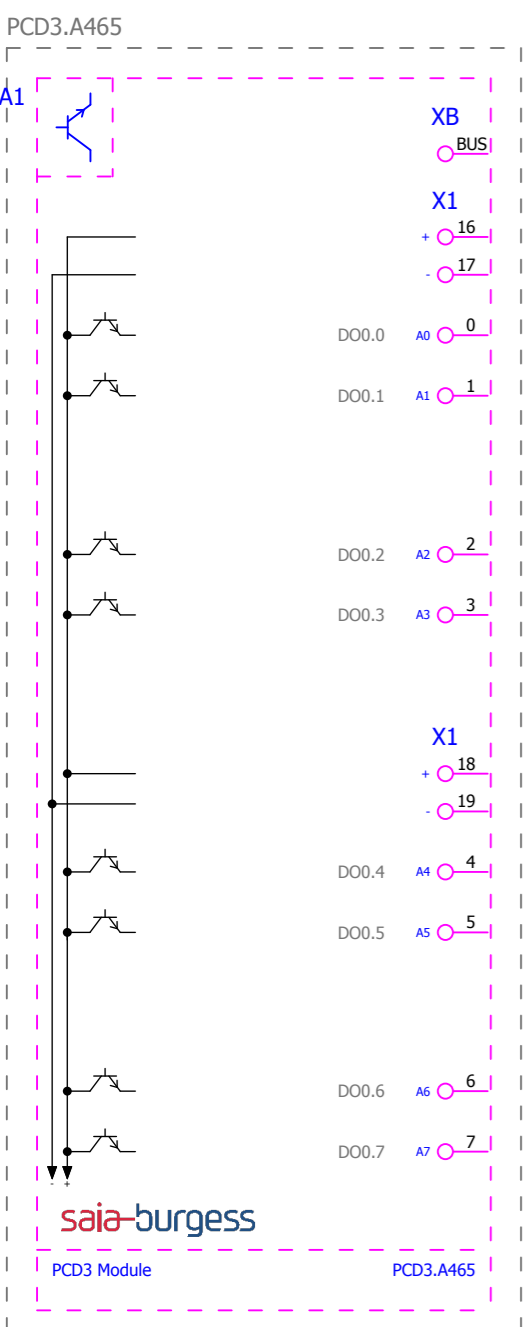

Saia-Burgess\PCD3 Module\PCD3.A465.ema
 Overview
 Variant A
 2012-10-26 / 2.1.4

- bus connector
- 24V DC
- Reserve
- Reserve
- Reserve
- Reserve
- 24V DC
- Reserve
- Reserve
- Reserve
- Reserve

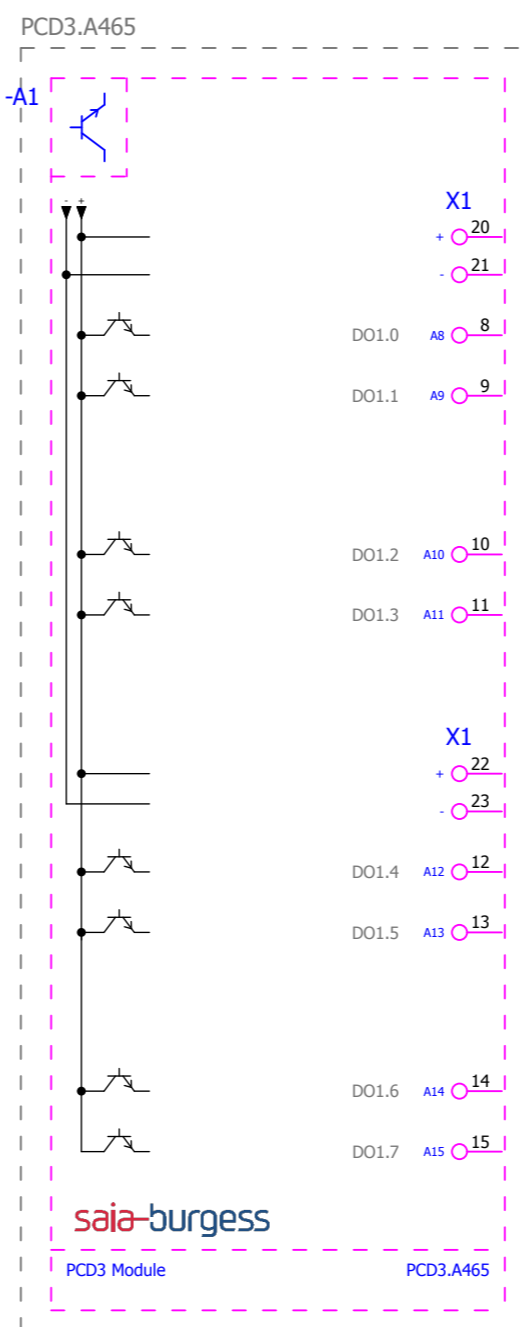

Saia-Burgess\PCD3 Module\PCD3.A465.ema
 Overview
 Variant B
 2012-10-26 / 2.1.4

- 24V DC
- Reserve
- Reserve
- Reserve
- Reserve
- 24V DC
- Reserve
- Reserve
- Reserve
- Reserve
- Reserve

			Datum	26.10.2012	EPLAN Software & Service Saia-Burgess Makroprojekt	Saia-Burgess Controls Ltd. Control Systems and Components	Saia-Burgess Controls Ltd.	SPS-Übersicht	= PCD3 Module		Blatt 10
			Bearb.	KAF					+ PCD3.A465		
			Gepr								
Änderung	Datum	Name	Urspr		Ersatz von	Ersetzt durch				Blatt	522

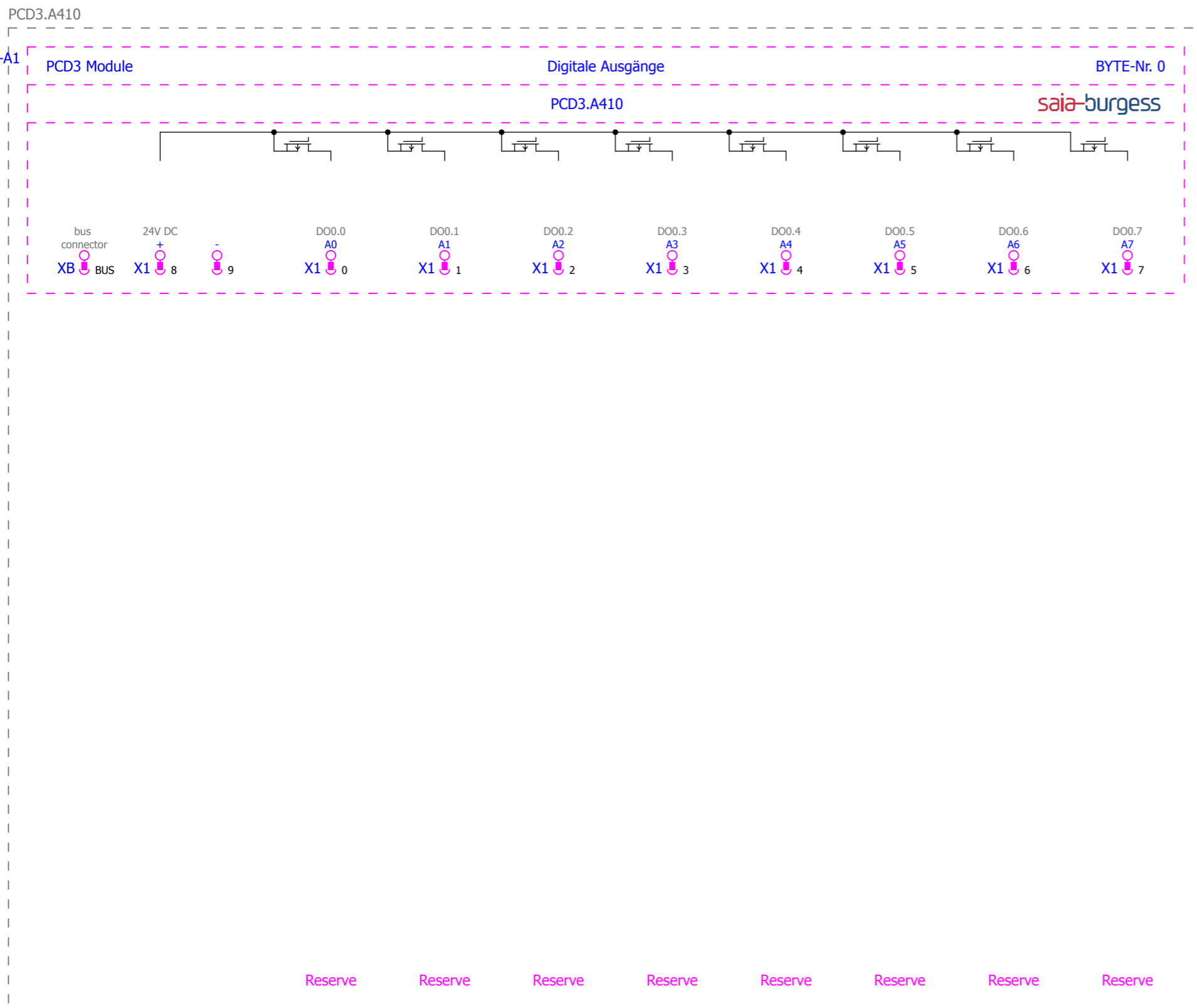

Saia-Burgess\PCD3 Module\PCD3.A410.ema
 Multi-line
 Variant A
 2012-10-26 / 2.1.4

+.A465/10

			Datum	26.10.2012	EPLAN Software & Service Saia-Burgess Makroprojekt	Saia-Burgess Controls Ltd. <small>Control Systems and Components</small>	Allpolig	= PCD3 Module	
			Bearb.	KAF				+ PCD3.A410	
			Gepr					Blatt	1
Änderung	Datum	Name	Urspr	Ersatz von	Ersetzt durch			Blatt	522

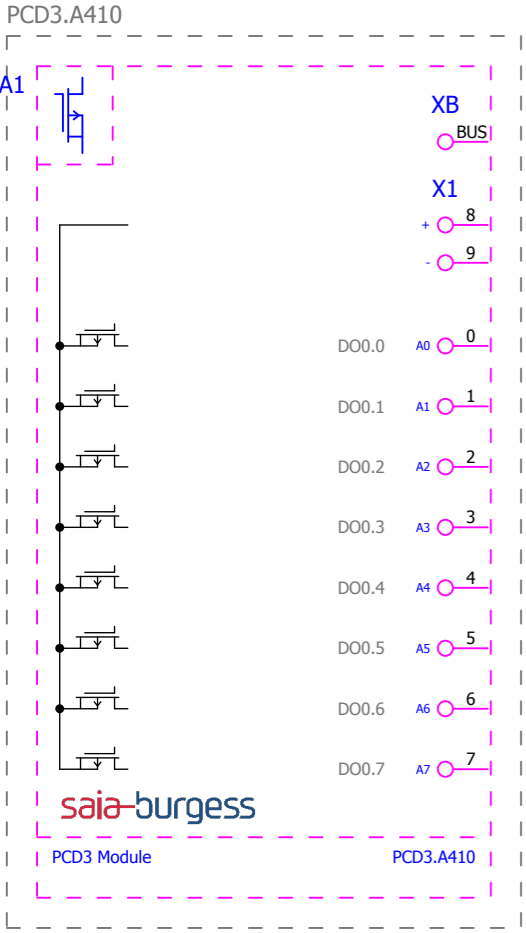

Saia-Burgess\PCD3 Module\PCD3.A410.ema
 Overview
 Variant A
 2012-10-26 / 2.1.4

- bus connector
- 24V DC
- Reserve
- Reserve
- Reserve
- Reserve
- Reserve
- Reserve
- Reserve
- Reserve

			Datum	26.10.2012	EPLAN Software & Service Saia-Burgess Makroprojekt	Saia-Burgess Controls Ltd. Control Systems and Components	Saia-Burgess Controls Ltd.	SPS-Übersicht	= PCD3 Module		Blatt 10
			Bearb.	KAF					+ PCD3.A410		
			Gepr								
Änderung	Datum	Name	Urspr		Ersatz von	Ersetzt durch				Blatt	522

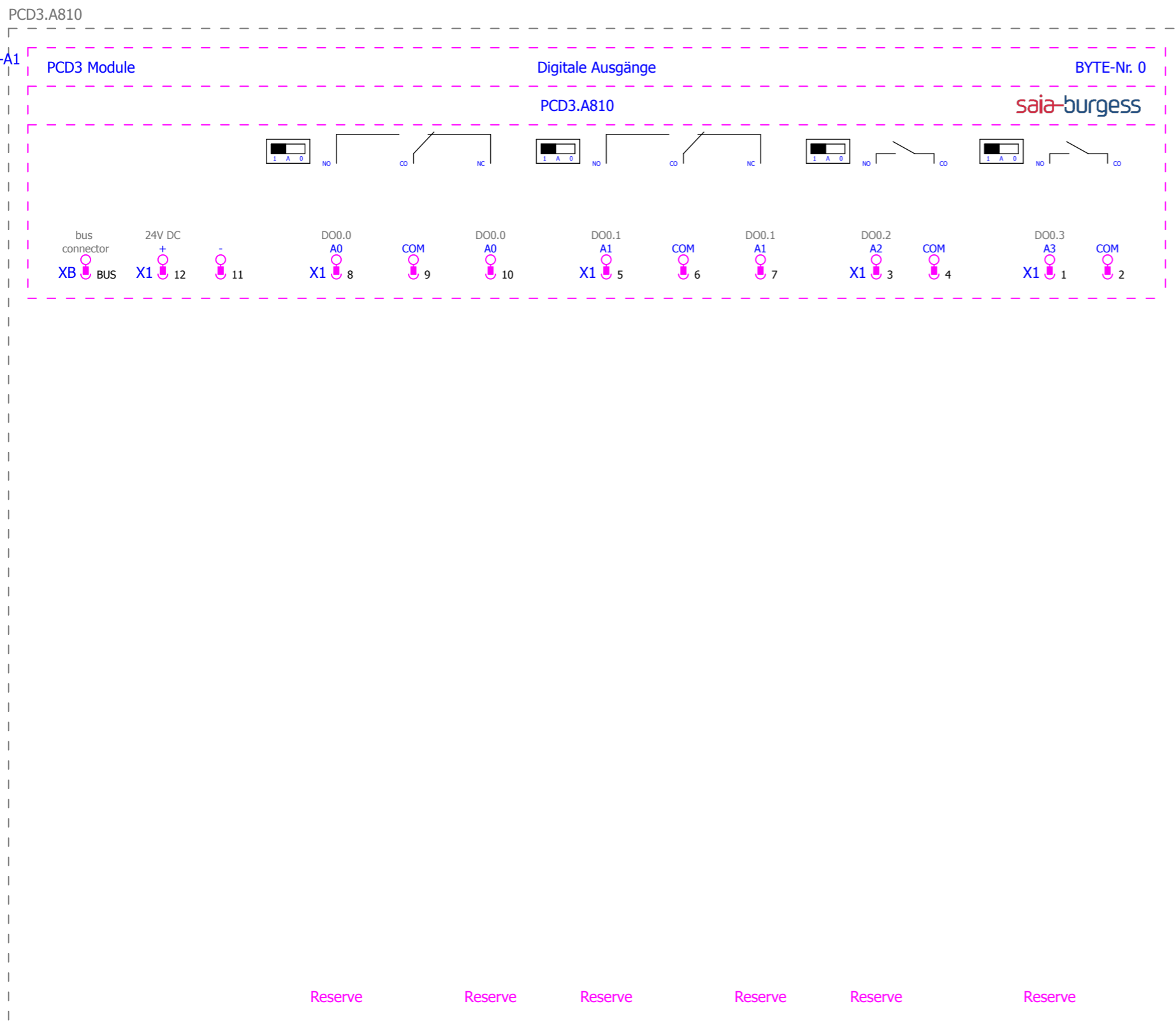

Saia-Burgess\PCD3 Module\PCD3.A810.ema
 Multi-line
 Variant A
 2012-10-26 / 2.1.4

+.A410/10

			Datum	26.10.2012	EPLAN Software & Service Saia-Burgess Makroprojekt	Saia-Burgess Controls Ltd. <small>Control Systems and Components</small>	Allpolig	= PCD3 Module	
		Bearb.	KAF	+ PCD3.A810					
		Gepr		Blatt				1	
Änderung	Datum	Name	Urspr	Ersatz von	Ersetzt durch			Blatt	522

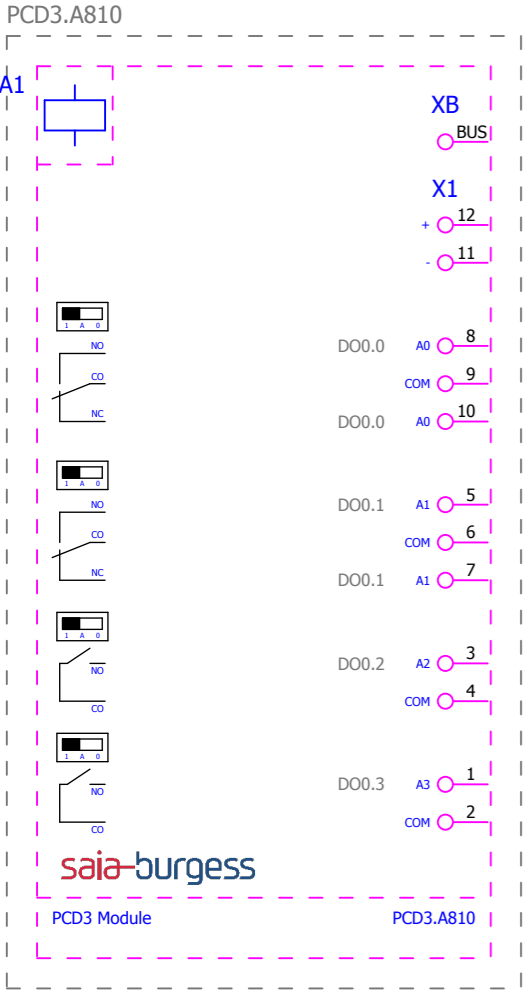

bus connector
 24V DC
 Reserve
 Reserve
 Reserve
 Reserve
 Reserve

Saia-Burgess
 PCD3 Module
 PCD3.A810
 Saia-Burgess\PCD3 Module\PCD3.A810.ema
 Overview
 Variant A
 2012-10-26 / 2.1.4

			Datum	26.10.2012	EPLAN Software & Service Saia-Burgess Makroprojekt	Saia-Burgess Controls Ltd. Control Systems and Components	Saia-Burgess Controls Ltd.	SPS-Übersicht	= PCD3 Module		Blatt 10
		Bearb.	KAF	+ PCD3.A810							
		Gepr									
Änderung	Datum	Name	Urspr		Ersatz von	Ersetzt durch				Blatt	522

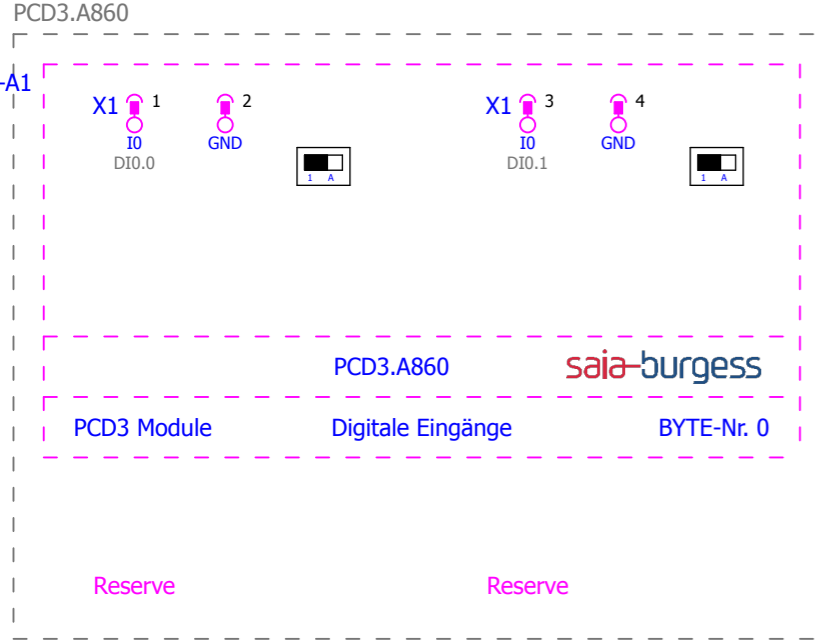

Saia-Burgess\PCD3 Module\PCD3.A860.ema
 Multi-line
 Variant B
 2012-10-26 / 2.1.4

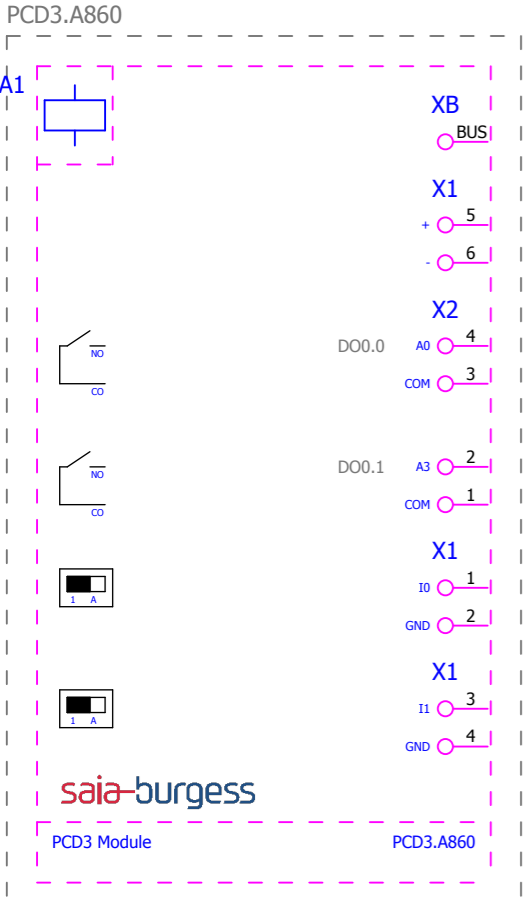

bus connector

24V DC

Reserve

Reserve

Reserve

Reserve

Saia-Burgess\PCD3 Module\PCD3.A860.ema
 Overview
 Variant A
 2012-10-26 / 2.1.4

			Datum	26.10.2012	EPLAN Software & Service Saia-Burgess Makroprojekt	Saia-Burgess Controls Ltd. Control Systems and Components	Saia-Burgess Controls Ltd.	SPS-Übersicht	= PCD3 Module		Blatt 10
		Bearb.	KAF	+ PCD3.A860							
		Gepr									
Änderung	Datum	Name	Urspr		Ersatz von	Ersetzt durch				Blatt	522

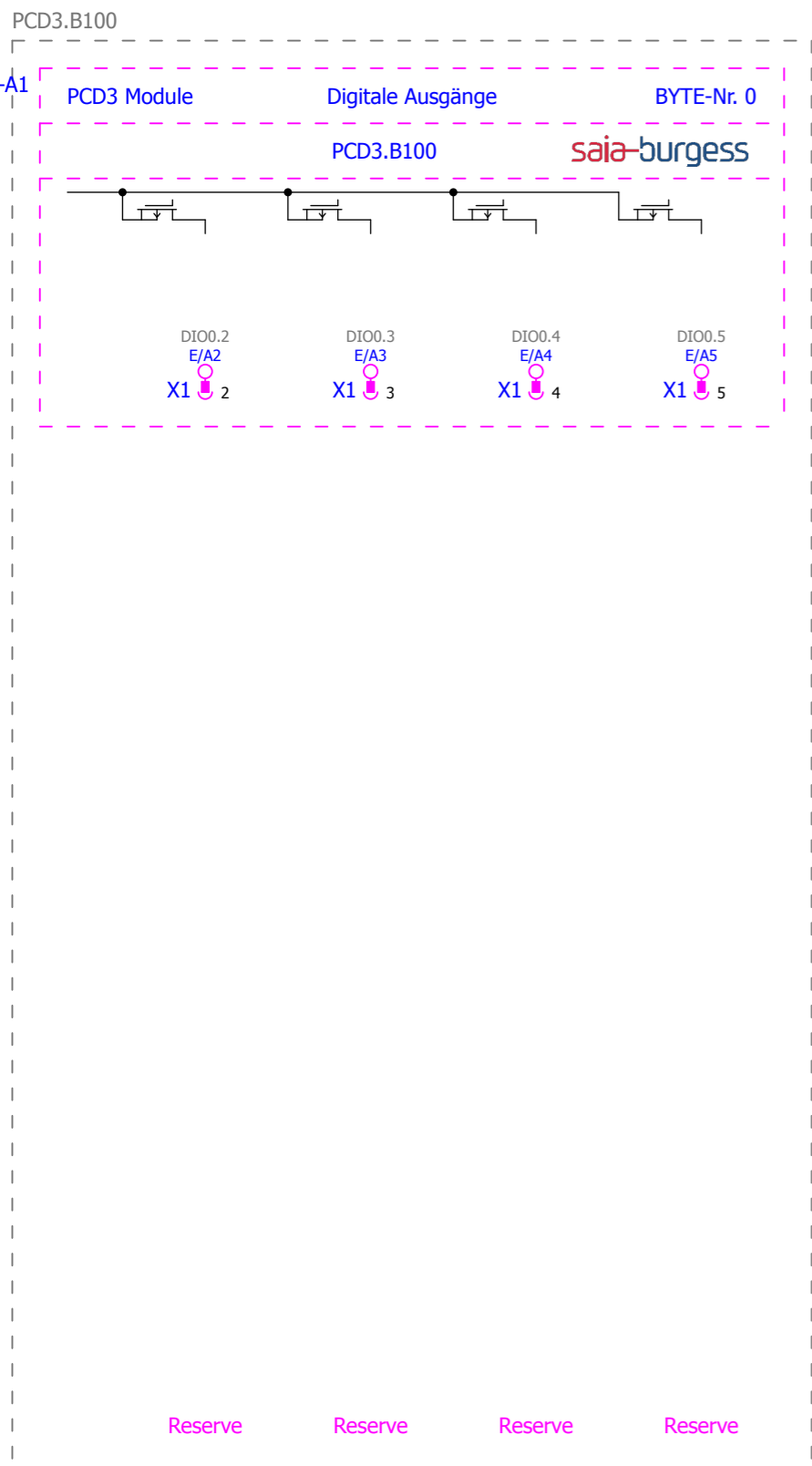

Saia-Burgess\PCD3 Module\PCD3.B100.ema
 Multi-line
 Variant B
 2012-10-26 / 2.1.4

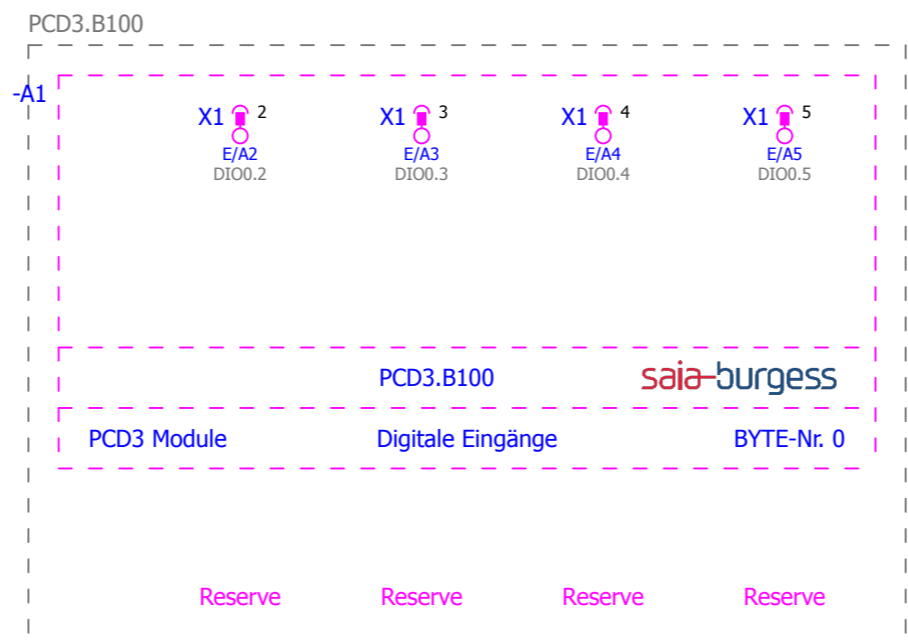

Saia-Burgess\PCD3 Module\PCD3.B100.ema
 Multi-line
 Variant C
 2012-10-26 / 2.1.4

1 for E/A2 to E/A5 delete if I/O is used as input

for E/A2 to E/A5 delete if I/O is used as output

			EPLAN Software & Service		Saia-Burgess Controls Ltd.		Allpolig		= PCD3 Module		
			Saia-Burgess Makroprojekt		Control Systems and Components				+ PCD3.B100		
Änderung	Datum	Name	Urspr	Ersatz von	Ersetzt durch					Blatt	2
										Blatt	522

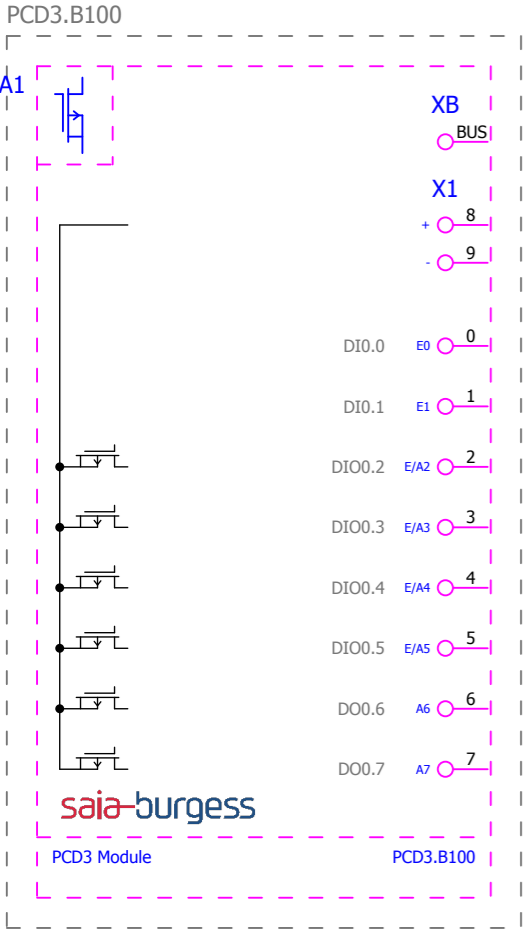

Saia-Burgess\PCD3 Module\PCD3.B100.ema
 Overview
 Variant A
 2012-10-26 / 2.1.4

- bus connector
- 24V DC
- Reserve
- Reserve
- Reserve
- Reserve
- Reserve
- Reserve
- Reserve
- Reserve
- Reserve

			Datum	26.10.2012	EPLAN Software & Service Saia-Burgess Makroprojekt	Saia-Burgess Controls Ltd. Control Systems and Components	Saia-Burgess Controls Ltd.	SPS-Übersicht	= PCD3 Module		Blatt 10
		Bearb.	KAF	+ PCD3.B100							
		Gepr									
Änderung	Datum	Name	Urspr		Ersatz von	Ersetzt durch				Blatt	522

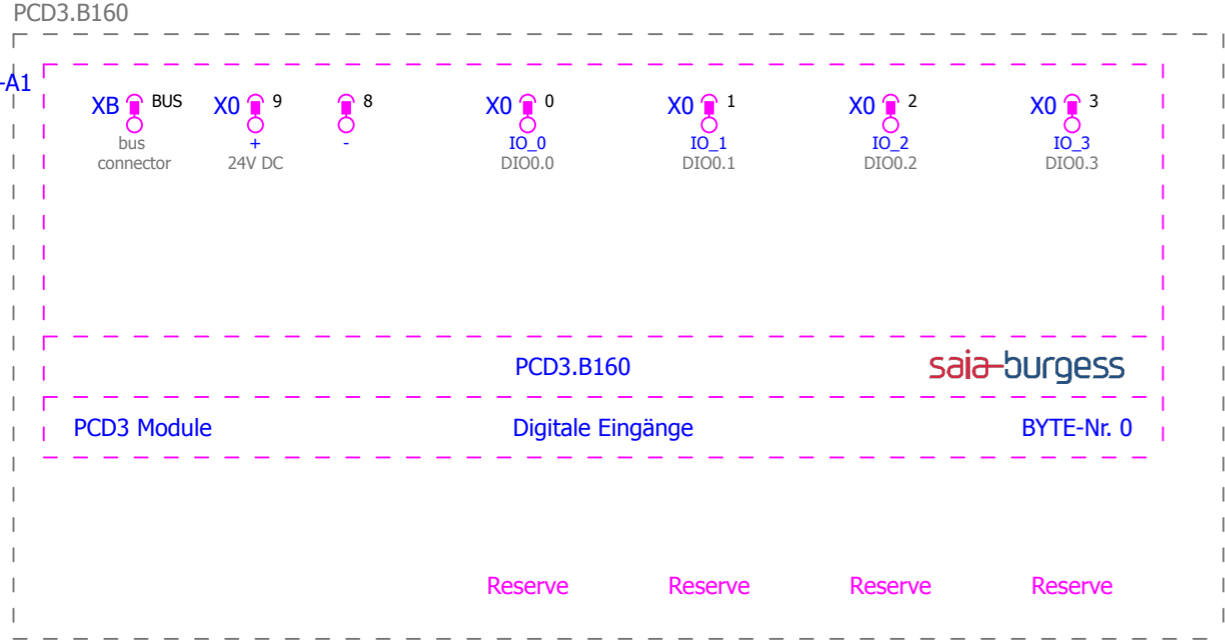

Saia-Burgess\PCD3 Module\PCD3.B160.ema
Multi-line
Variant E
2012-10-26 / 2.1.4

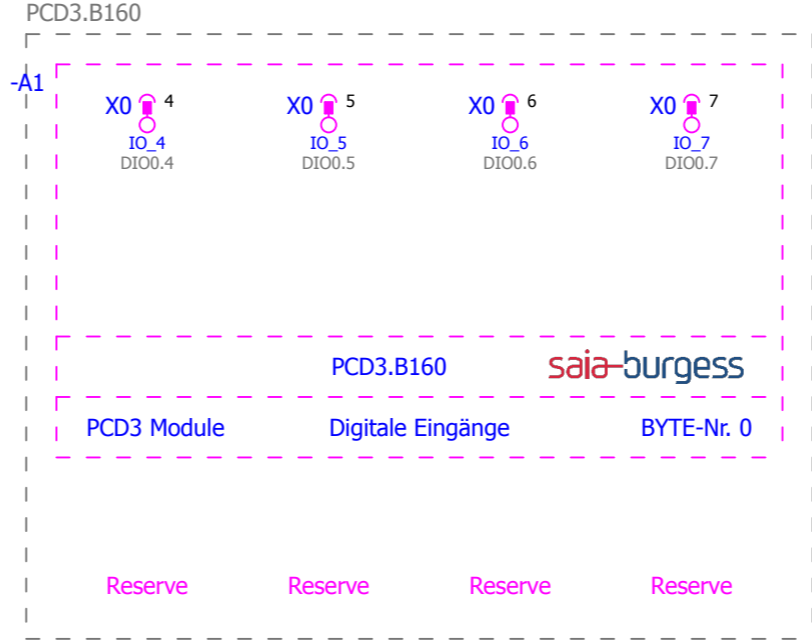

Saia-Burgess\PCD3 Module\PCD3.B160.ema
Multi-line
Variant F
2012-10-26 / 2.1.4

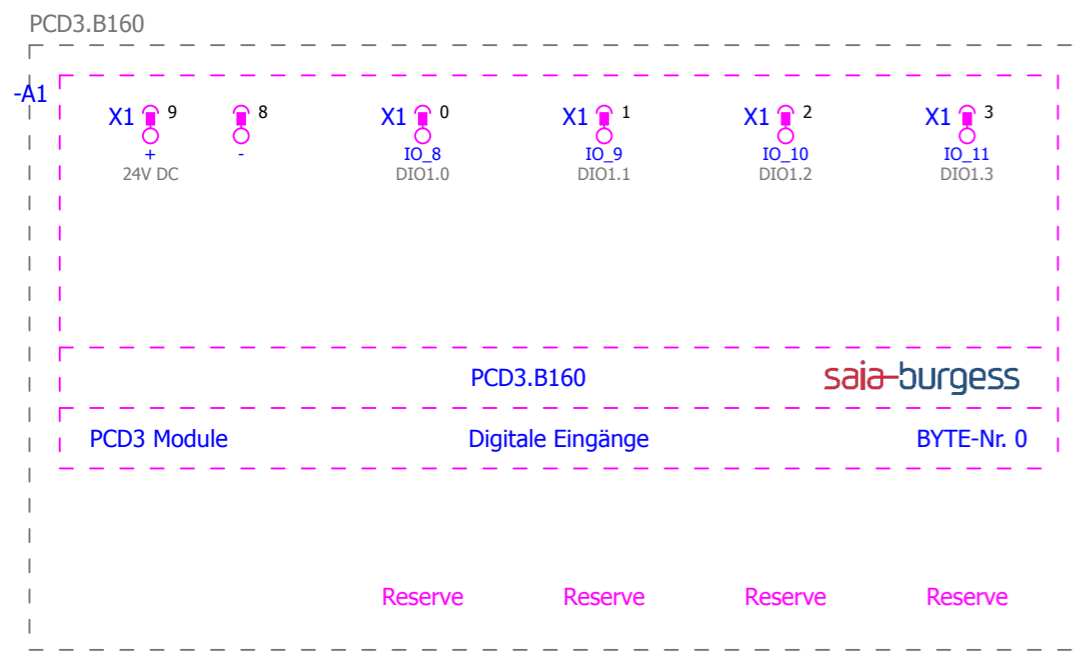

Saia-Burgess\PCD3 Module\PCD3.B160.ema
 Multi-line
 Variant G
 2012-10-26 / 2.1.4

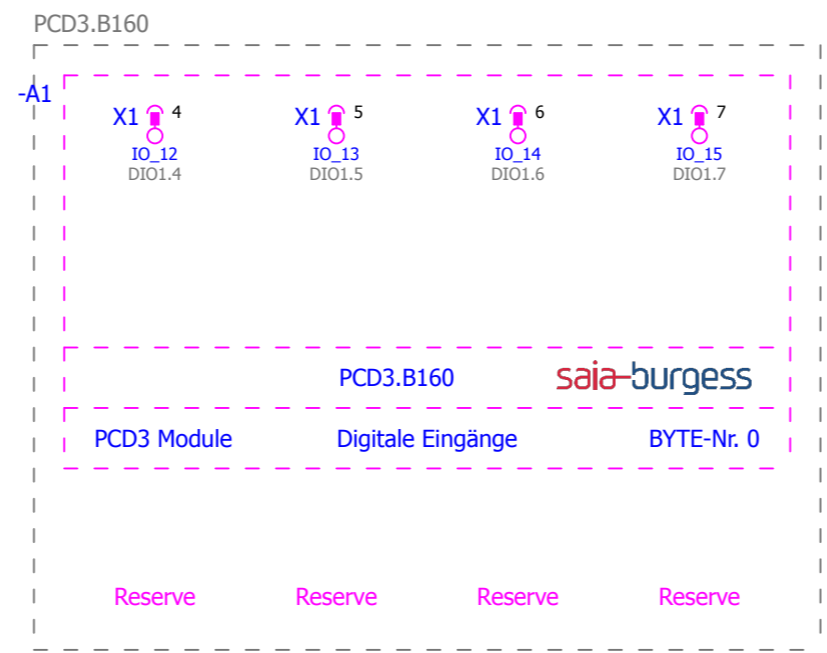

Saia-Burgess\PCD3 Module\PCD3.B160.ema
 Multi-line
 Variant H
 2012-10-26 / 2.1.4

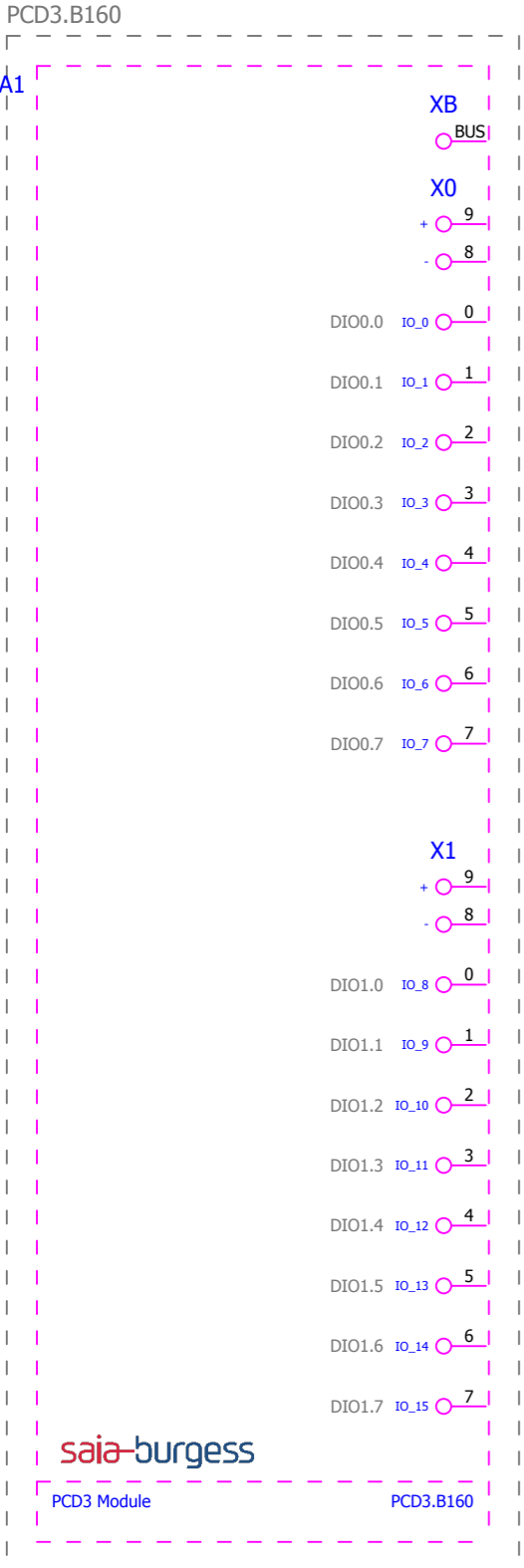

bus connector
 24V DC
 Reserve
 Reserve
 Reserve
 Reserve
 Reserve
 Reserve
 Reserve
 Reserve
 Reserve
 Reserve
 Reserve
 Reserve
 Reserve
 Reserve
 Reserve

Saia-Burgess\PCD3 Module\PCD3.B160.ema
 Overview
 Variant A
 2012-10-26 / 2.1.4

			Datum	26.10.2012	EPLAN Software & Service Saia-Burgess Makroprojekt	Saia-Burgess Controls Ltd. Control Systems and Components	Saia-Burgess Controls Ltd.	SPS-Übersicht	= PCD3 Module		Blatt 10
		Bearb.	KAF	+ PCD3.B160							
		Gepr									
Änderung	Datum	Name	Ürspr	Ersatz von	Ersetzt durch					Blatt	522

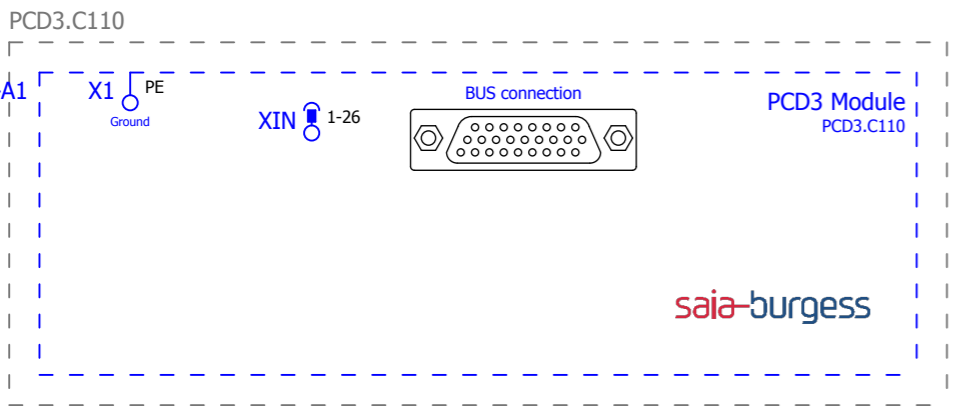

Saia-Burgess\PCD3 Module\PCD3.C110.ema
 Multi-line
 Variant A
 2012-10-26 / 2.1.4

			Datum	26.10.2012	 EPLAN Software & Service  Saia-Burgess Makroprojekt	 Control Systems and Components	Saia-Burgess Controls Ltd.	Allpolig	= PCD3 Module		Blatt 1
		Bearb.	KAF	+ PCD3.C110							
		Gepr									
Änderung	Datum	Name	Urspr		Ersatz von	Ersetzt durch				Blatt	522

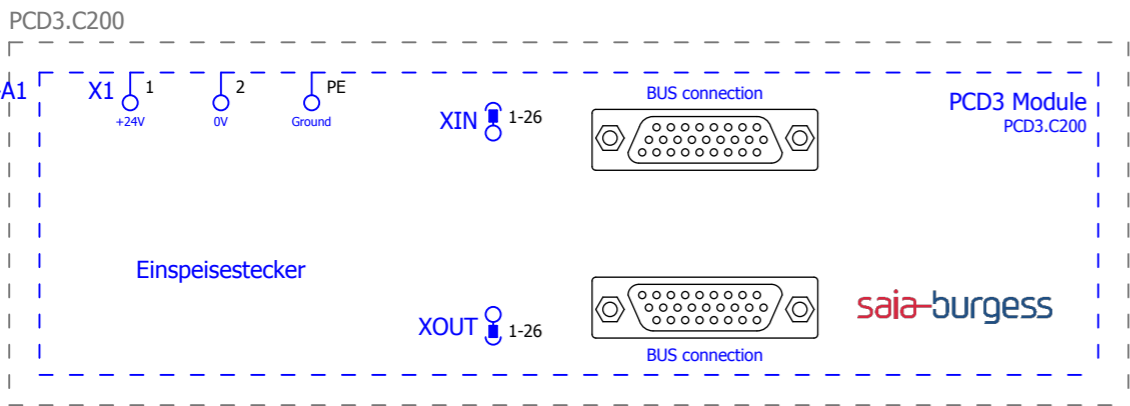

Saia-Burgess\PCD3 Module\PCD3.C200.ema
 Multi-line
 Variant A
 2012-10-26 / 2.1.4

			Datum	26.10.2012	EPLAN Software & Service Saia-Burgess Makroprojekt	Saia-Burgess Controls Ltd. Control Systems and Components	Saia-Burgess Controls Ltd.	Allpolig	= PCD3 Module		Blatt 1
		Bearb.	KAF	+ PCD3.C200							
		Gepr									
Änderung	Datum	Name	Urspr		Ersatz von	Ersetzt durch				Blatt	522

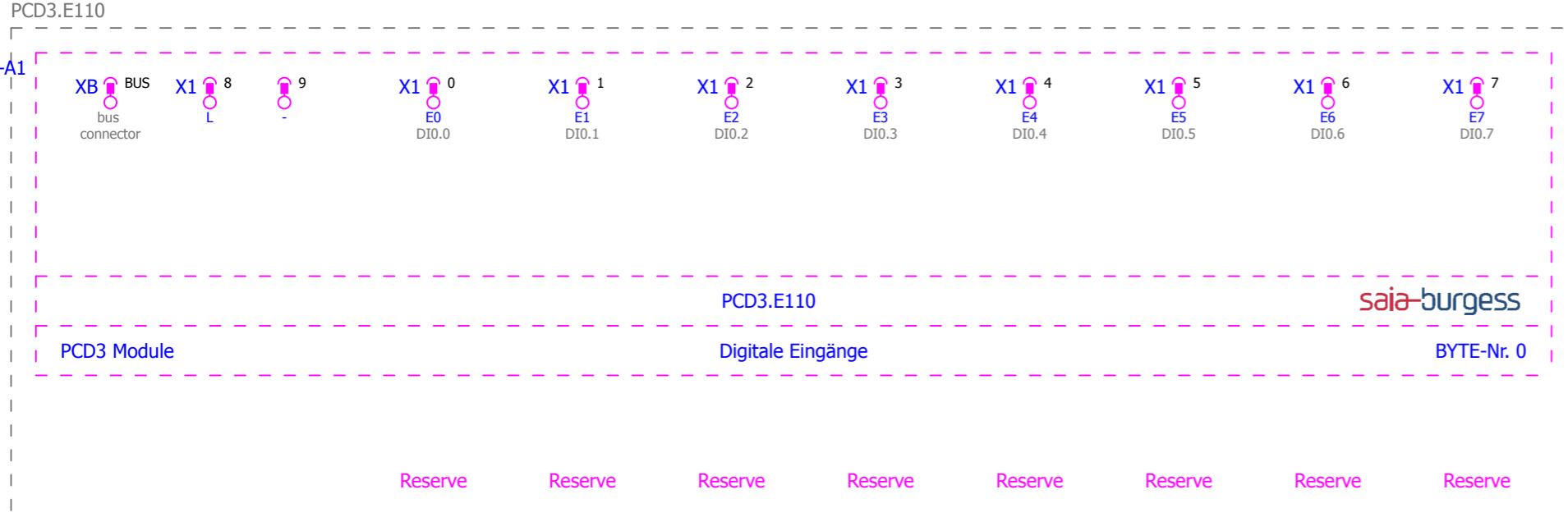

Saia-Burgess\PCD3 Module\PCD3.E110.ema
 Multi-line
 Variant A
 2012-10-26 / 2.1.4

			Datum	26.10.2012	EPLAN Software & Service Saia-Burgess Makroprojekt	Saia-Burgess Controls Ltd. Control Systems and Components	Saia-Burgess Controls Ltd.	Allpolig	= PCD3 Module		Blatt 1	
			Bearb.	KAF					+ PCD3.E110			Blatt 522
			Gepr									
Änderung	Datum	Name	Urspr		Ersatz von	Ersetzt durch						

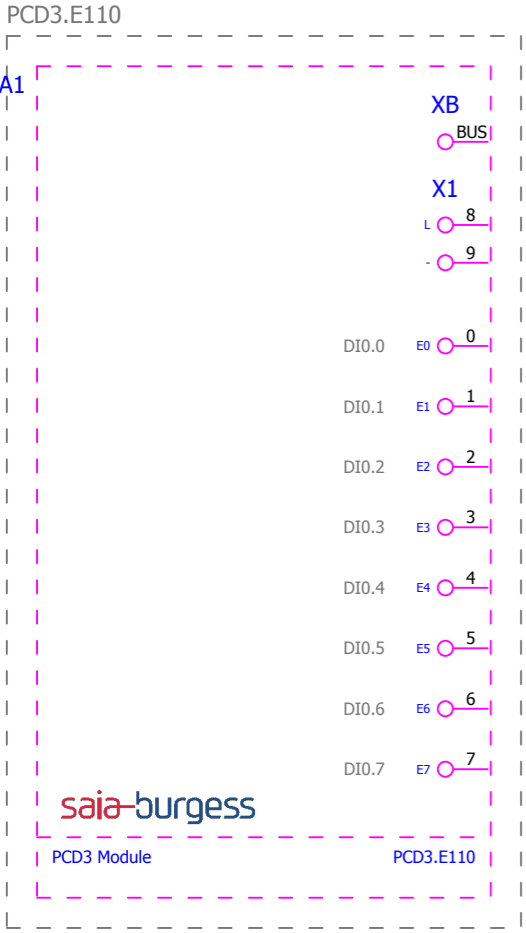

bus connector

Reserve

Reserve

Reserve

Reserve

Reserve

Reserve

Reserve

Reserve

Reserve

Saia-Burgess\PCD3 Module\PCD3.E110.ema
Overview
Variant A
2012-10-26 / 2.1.4

			Datum	26.10.2012	EPLAN Software & Service Saia-Burgess Makroprojekt	Saia-Burgess Controls Ltd. Control Systems and Components	Saia-Burgess Controls Ltd.	SPS-Übersicht	= PCD3 Module		Blatt 10
			Bearb.	KAF					+ PCD3.E110		
			Gepr								
Änderung	Datum	Name	Urspr		Ersatz von	Ersetzt durch					

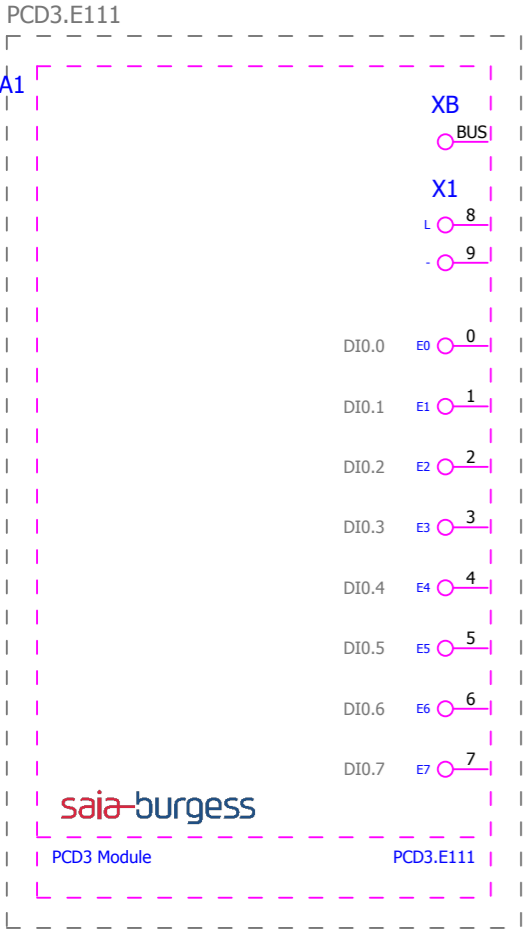

bus connector

Reserve

Reserve

Reserve

Reserve

Reserve

Reserve

Reserve

Reserve

Reserve

Saia-Burgess\PCD3 Module\PCD3.E111.ema
 Overview
 Variant A
 2012-10-26 / 2.1.4

			Datum	26.10.2012	EPLAN Software & Service Saia-Burgess Makroprojekt	Saia-Burgess Controls Ltd. Control Systems and Components	Saia-Burgess Controls Ltd.	SPS-Übersicht	= PCD3 Module		Blatt 10
			Bearb.	KAF					+ PCD3.E111		
			Gepr								
Änderung	Datum	Name	Urspr		Ersatz von	Ersetzt durch				Blatt	522

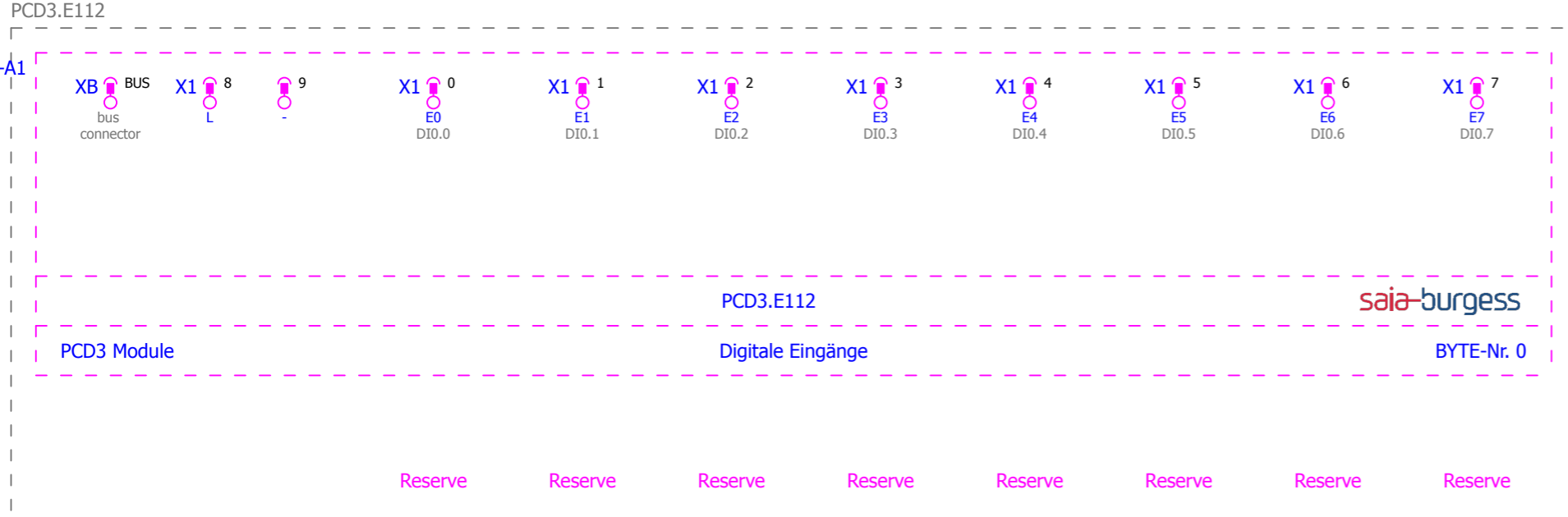

Saia-Burgess\PCD3 Module\PCD3.E112.ema
 Multi-line
 Variant A
 2012-10-26 / 2.1.4

+.E111/10

10

			Datum	26.10.2012	EPLAN Software & Service Saia-Burgess Makroprojekt	 Control Systems and Components	Saia-Burgess Controls Ltd.	Allpolig	= PCD3 Module	
		Bearb.	KAF	+ PCD3.E112						
		Gepr		Blatt					1	
Änderung	Datum	Name	Urspr	Ersatz von	Ersetzt durch				Blatt	522

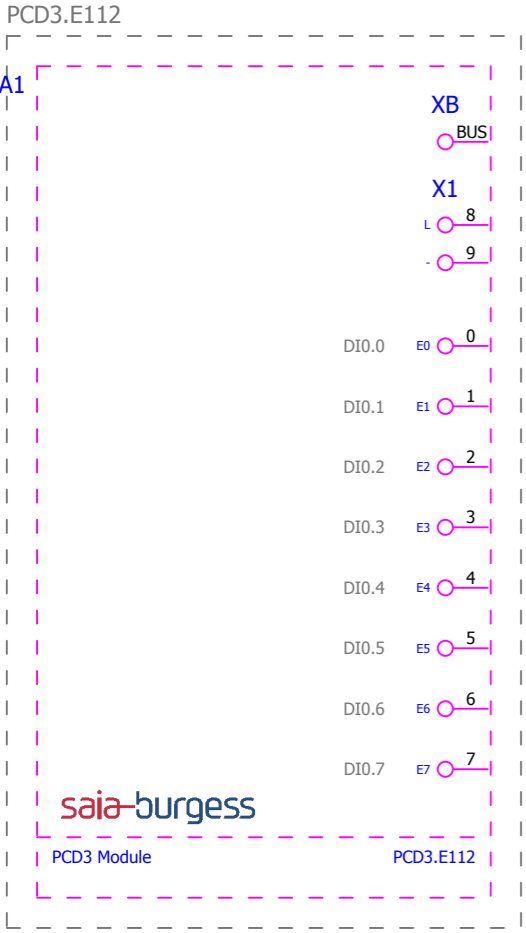

bus connector

Reserve

Reserve

Reserve

Reserve

Reserve

Reserve

Reserve

Reserve

Reserve

Saia-Burgess\PCD3 Module\PCD3.E112.ema
 Overview
 Variant A
 2012-10-26 / 2.1.4

			Datum	26.10.2012	EPLAN Software & Service Saia-Burgess Makroprojekt	Saia-Burgess Controls Ltd. Control Systems and Components	Saia-Burgess Controls Ltd.	SPS-Übersicht	= PCD3 Module		Blatt 10
			Bearb.	KAF					+ PCD3.E112		
			Gepr								
Änderung	Datum	Name	Urspr		Ersatz von	Ersetzt durch					

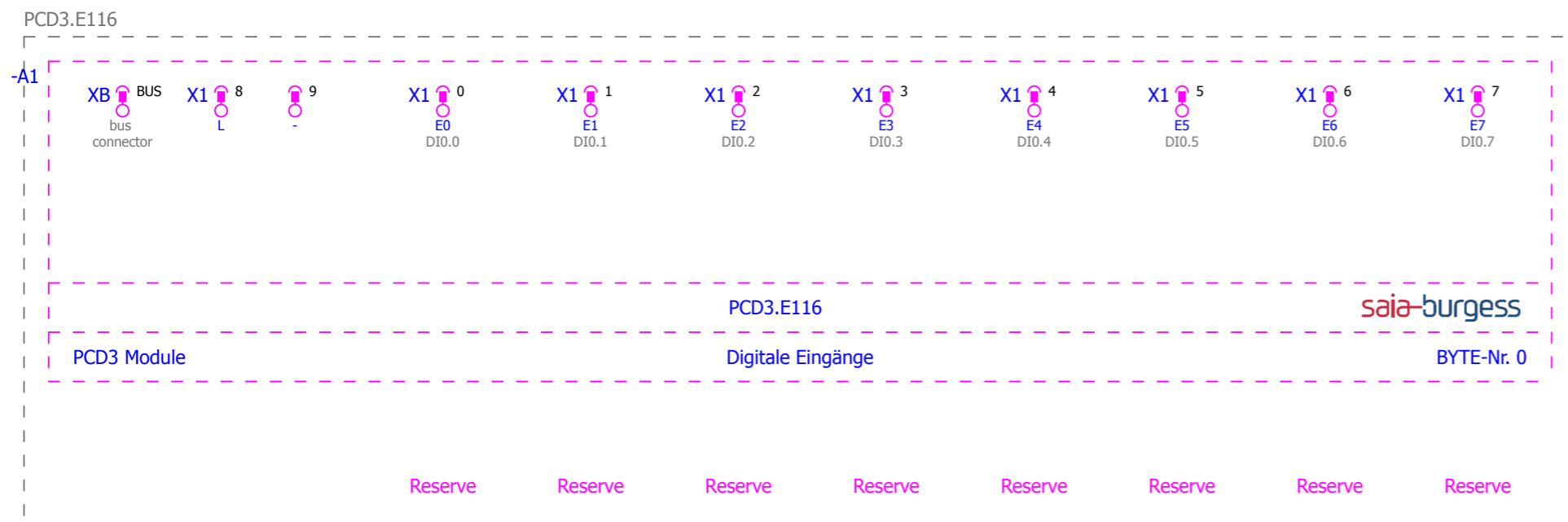

Saia-Burgess\PCD3 Module\PCD3.E116.ema
 Multi-line
 Variant A
 2012-10-26 / 2.1.4

+ .E112/10

			Datum	26.10.2012	EPLAN Software & Service Saia-Burgess Makroprojekt	Saia-Burgess Controls Ltd. Control Systems and Components	Saia-Burgess Controls Ltd.	Allpolig	= PCD3 Module	
		Bearb.	KAF	+ PCD3.E116						
		Gepr		Blatt					1	
Änderung	Datum	Name	Urspr	Ersatz von	Ersetzt durch				Blatt	522

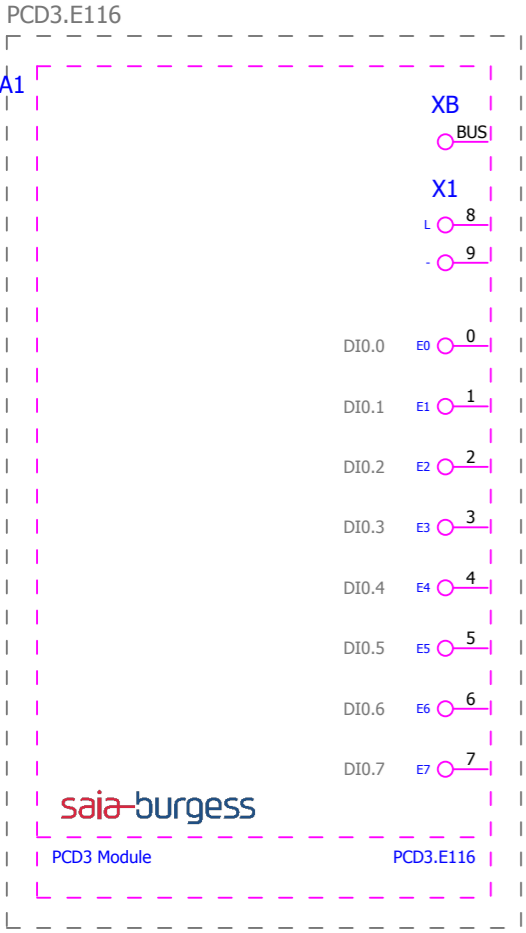

Saia-Burgess\PCD3 Module\PCD3.E116.ema
 Overview
 Variant A
 2012-10-26 / 2.1.4

bus connector

 Reserve
 Reserve
 Reserve
 Reserve
 Reserve
 Reserve
 Reserve
 Reserve

			Datum	26.10.2012	EPLAN Software & Service Saia-Burgess Makroprojekt	Saia-Burgess Controls Ltd. <small>Control Systems and Components</small>	Saia-Burgess Controls Ltd.	SPS-Übersicht	= PCD3 Module		Blatt 10
			Bearb.	KAF					+ PCD3.E116		
			Gepr								
Änderung	Datum	Name	Urspr		Ersatz von	Ersetzt durch				Blatt	522

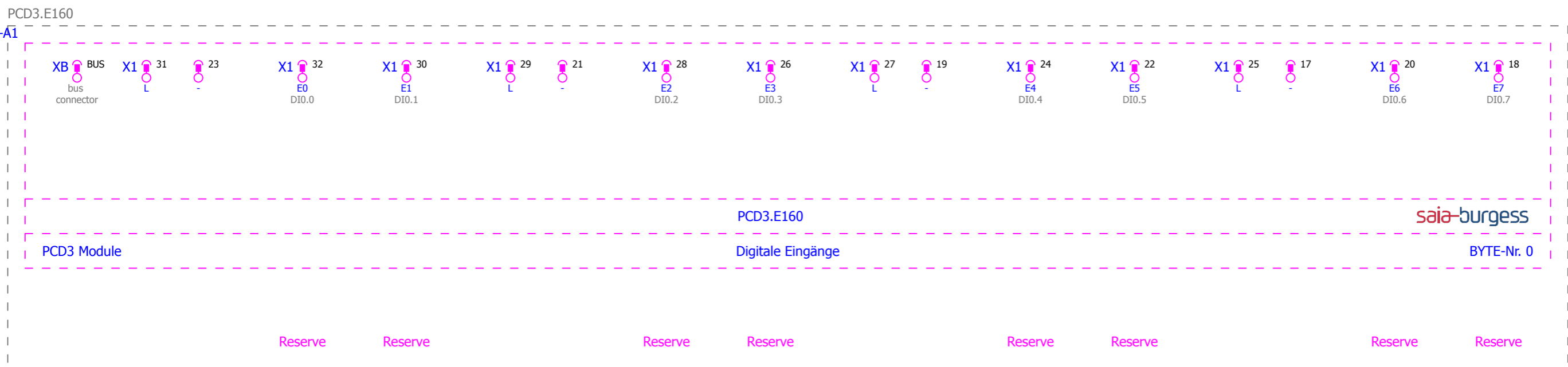

Saia-Burgess\PCD3 Module\PCD3.E160.ema
 Multi-line
 Variant A
 2012-10-26 / 2.1.4

PCD3.E160

-A1

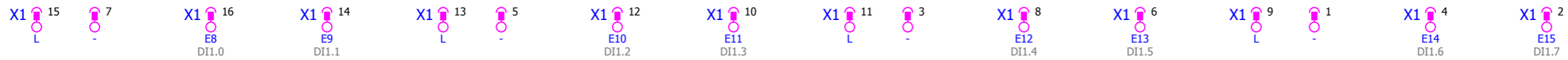

PCD3.E160

saia-burgess

PCD3 Module

Digitale Eingänge

BYTE-Nr. 1

Reserve

Reserve

Reserve

Reserve

Reserve

Reserve

Reserve

Reserve

Saia-Burgess\PCD3 Module\PCD3.E160.ema
 Multi-line
 Variant B
 2012-10-26 / 2.1.4

			Datum	26.10.2012	EPLAN Software & Service Saia-Burgess Makroprojekt	Saia-Burgess Controls Ltd. Control Systems and Components	Allpolig		= PCD3 Module	Blatt 2
		Bearb.	KAF	+ PCD3.E160						
Änderung	Datum	Name	Urspr	Ersatz von					Ersetzt durch	

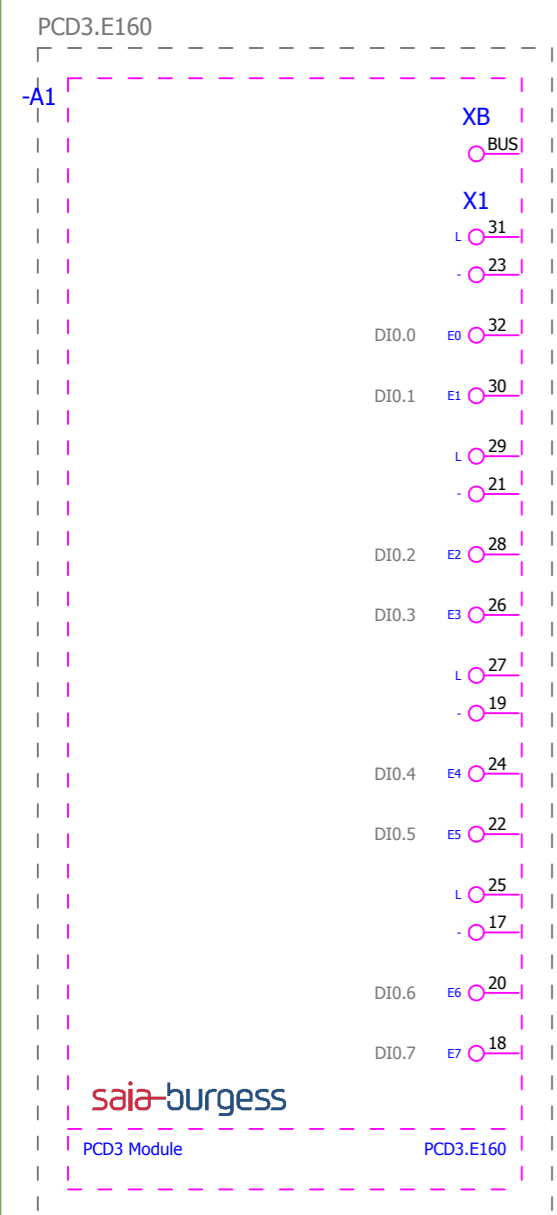

bus connector

Reserve

Reserve

Reserve

Reserve

Reserve

Reserve

Reserve

Reserve

Reserve

Reserve

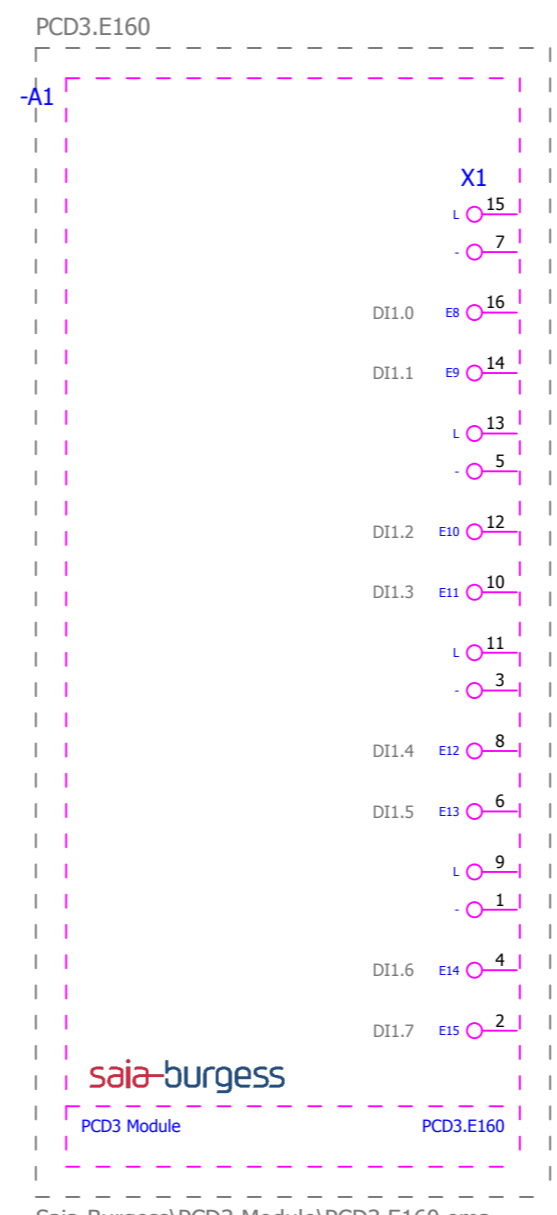

Reserve

Reserve

Reserve

Reserve

Reserve

Reserve

Reserve

Reserve

Saia-Burgess\PCD3 Module\PCD3.E160.ema
 Overview
 Variant B
 2012-10-26 / 2.1.4

Saia-Burgess\PCD3 Module\PCD3.E160.ema
 Overview
 Variant A
 2012-10-26 / 2.1.4

			Datum	26.10.2012	EPLAN Software & Service Saia-Burgess Makroprojekt	Saia-Burgess Controls Ltd. Control Systems and Components	Saia-Burgess Controls Ltd.	SPS-Übersicht	= PCD3 Module	
			Bearb.	KAF					+ PCD3.E160	
			Gepr						Blatt	10
Änderung	Datum	Name	Urspr		Ersatz von	Ersetzt durch			Blatt	522

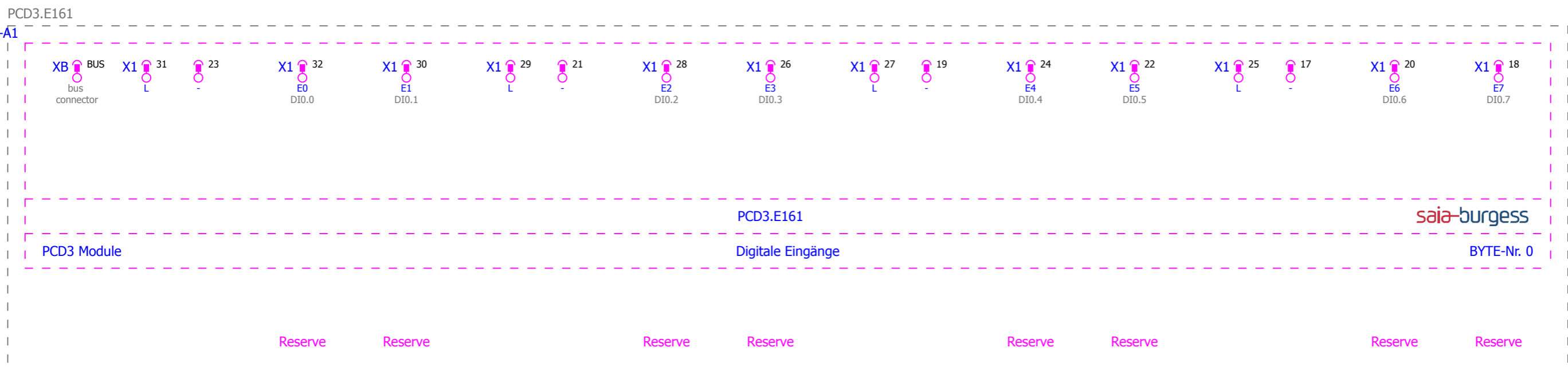

Saia-Burgess\PCD3 Module\PCD3.E161.ema
 Multi-line
 Variant A
 2012-10-26 / 2.1.4

+ .E160/10

			Datum	26.10.2012	EPLAN Software & Service Saia-Burgess Makroprojekt	 Control Systems and Components	Saia-Burgess Controls Ltd.		Allpolig		= PCD3 Module	
			Bearb.	KAF							+ PCD3.E161	
			Gepr								Blatt 1	
Änderung	Datum	Name	Urspr		Ersatz von	Ersetzt durch					Blatt 522	

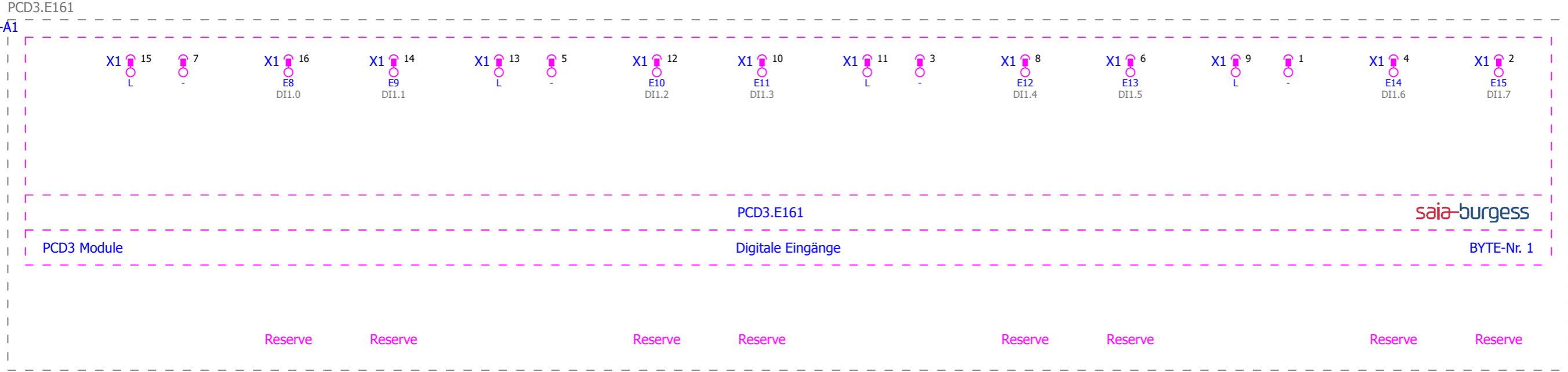

Saia-Burgess\PCD3 Module\PCD3.E161.ema
 Multi-line
 Variant B
 2012-10-26 / 2.1.4

			Datum	26.10.2012	EPLAN Software & Service Saia-Burgess Makroprojekt	Saia-Burgess Controls Ltd. Control Systems and Components	Allpolig	= PCD3 Module		Blatt 2
			Bearb.	KAF				+ PCD3.E161		
			Gepr							
Änderung	Datum	Name	Urspr	Ersatz von	Ersetzt durch			Blatt 522		

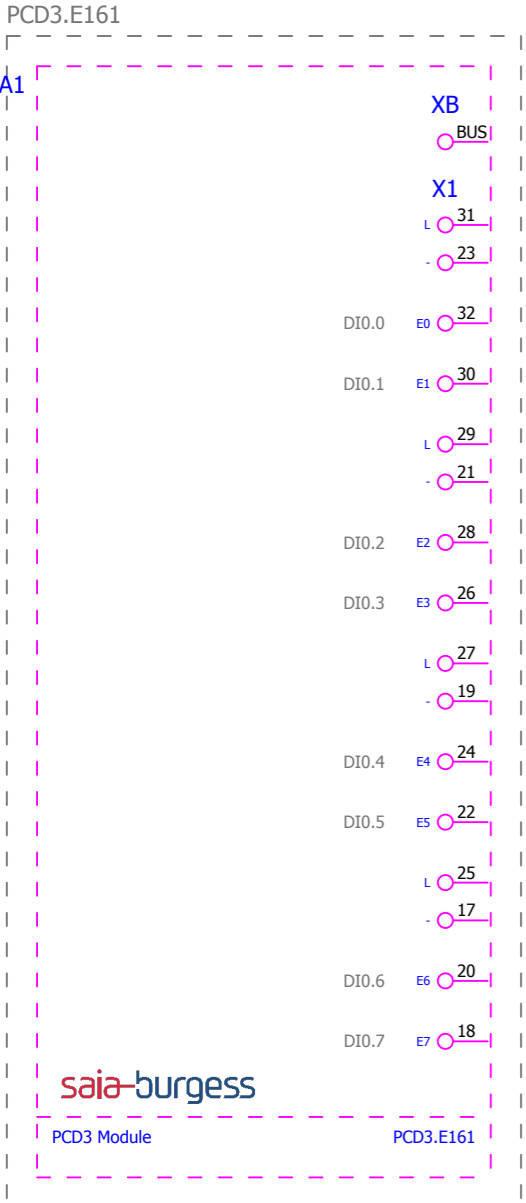

Saia-Burgess\PCD3 Module\PCD3.E161.ema
 Overview
 Variant A
 2012-10-26 / 2.1.4

bus connector

Reserve

Reserve

Reserve

Reserve

Reserve

Reserve

Reserve

Reserve

Reserve

Reserve

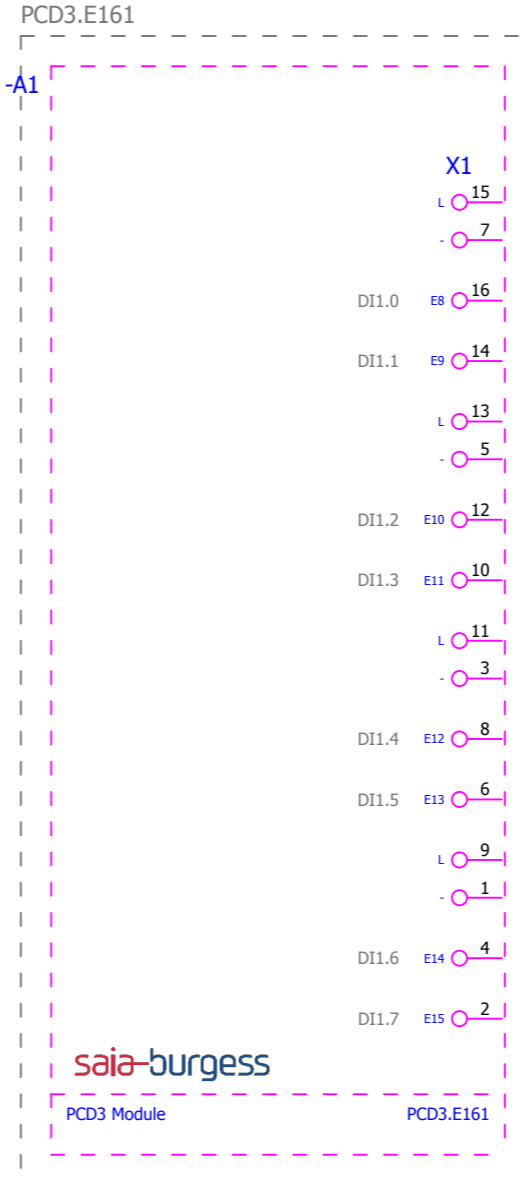

Saia-Burgess\PCD3 Module\PCD3.E161.ema
 Overview
 Variant B
 2012-10-26 / 2.1.4

Reserve

Reserve

Reserve

Reserve

Reserve

Reserve

Reserve

Reserve

			Datum	26.10.2012	EPLAN Software & Service Saia-Burgess Makroprojekt <small>Control Systems and Components</small>	Saia-Burgess Controls Ltd.	SPS-Übersicht	= PCD3 Module	
			Bearb.	KAF				+ PCD3.E161	
			Gepr					Blatt	10
Änderung	Datum	Name	Urspr		Ersatz von	Ersetzt durch		Blatt	522

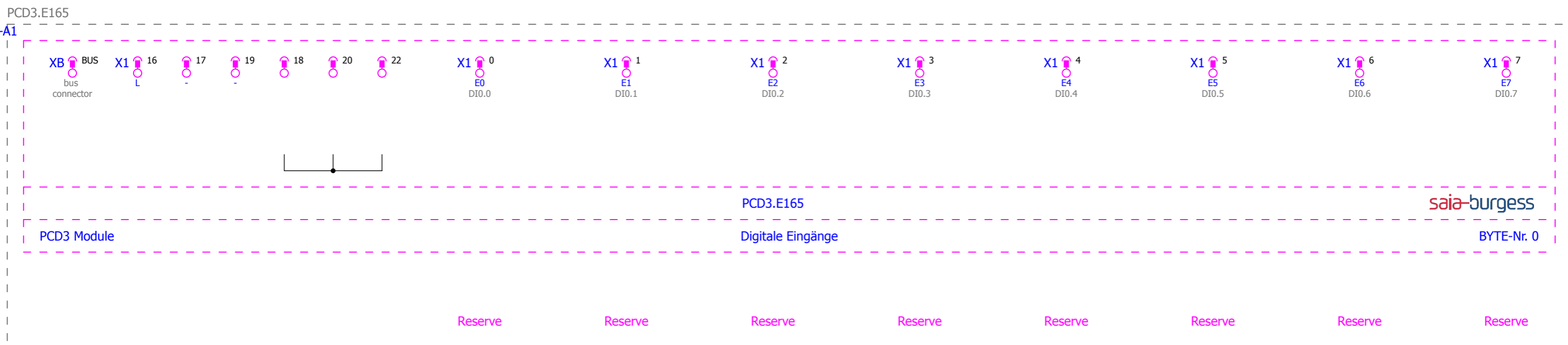

Saia-Burgess\PCD3 Module\PCD3.E165.ema
 Multi-line
 Variant A
 2012-10-26 / 2.1.4

+.E161/10

		Datum 26.10.2012		EPLAN Software & Service Saia-Burgess Makroprojekt	Saia-Burgess Controls Ltd. Control Systems and Components	Allpolig	= PCD3 Module		
		Bearb. KAF					+ PCD3.E165		Blatt 1
		Gepr							Blatt 522
Änderung	Datum	Name	Urspr	Ersatz von	Ersetzt durch				

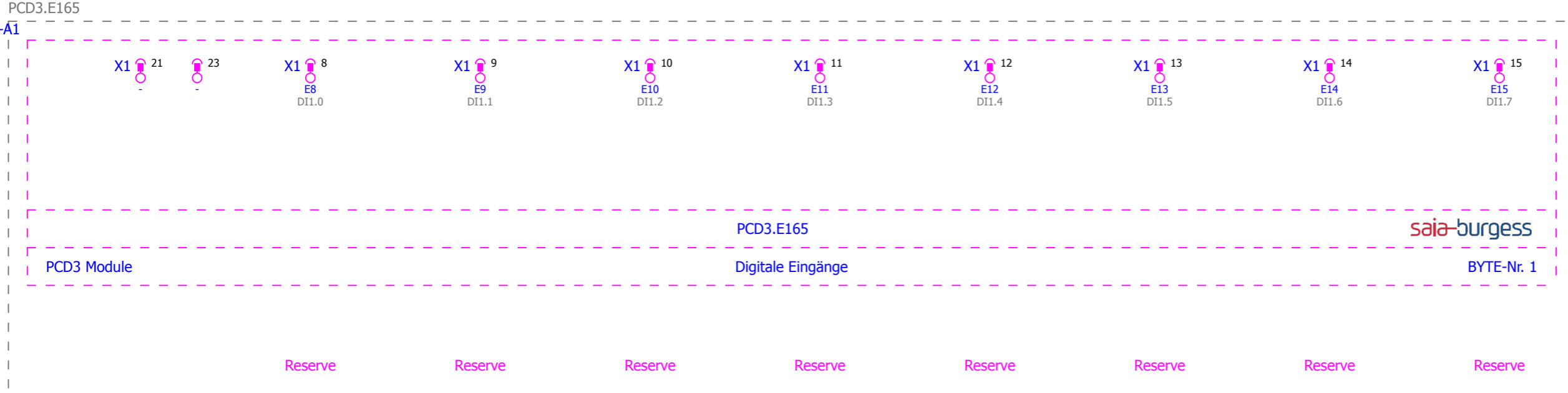

Saia-Burgess\PCD3 Module\PCD3.E165.ema
 Multi-line
 Variant B
 2012-10-26 / 2.1.4

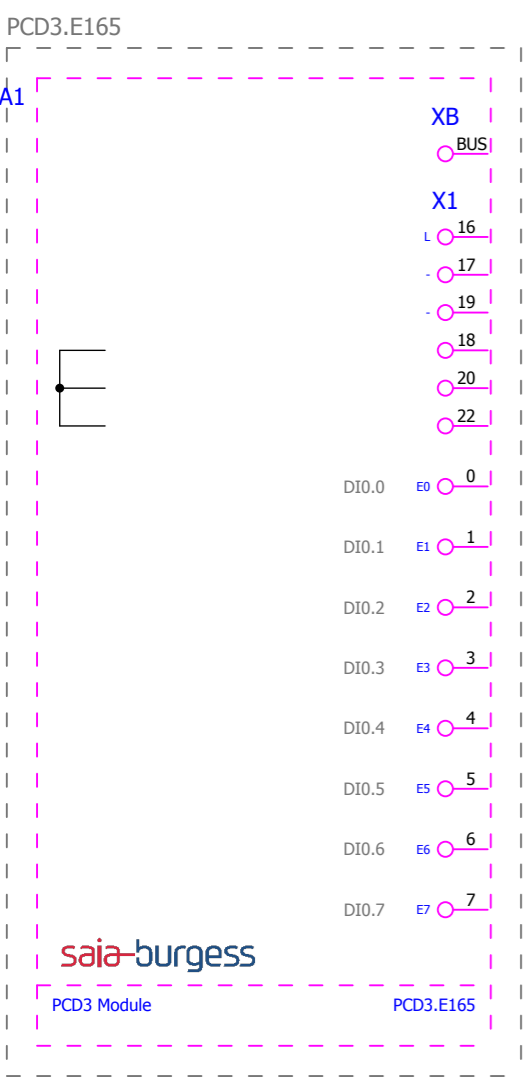

Saia-Burgess\PCD3 Module\PCD3.E165.ema
 Overview
 Variant A
 2012-10-26 / 2.1.4

bus connector

- Reserve
- Reserve
- Reserve
- Reserve
- Reserve
- Reserve
- Reserve
- Reserve
- Reserve
- Reserve

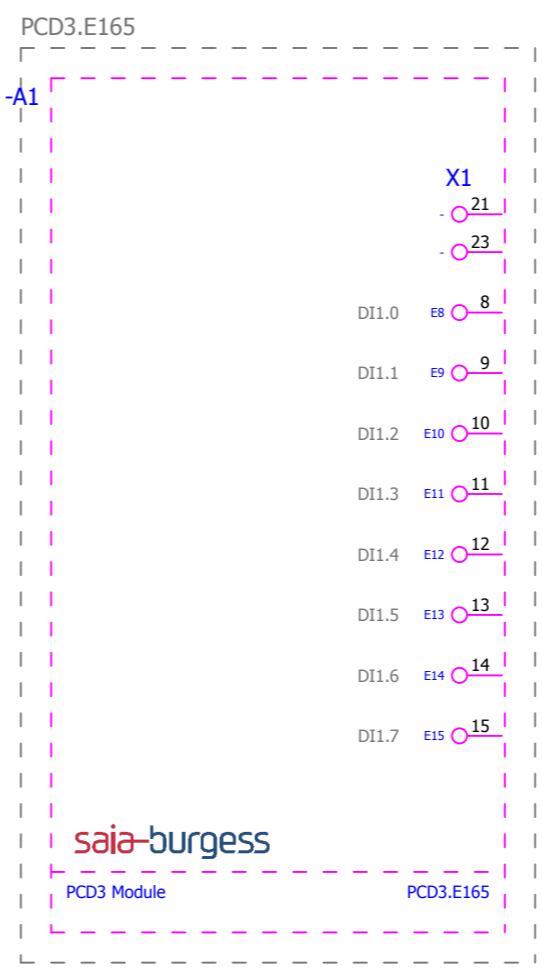

Saia-Burgess\PCD3 Module\PCD3.E165.ema
 Overview
 Variant B
 2012-10-26 / 2.1.4

- Reserve
- Reserve
- Reserve
- Reserve
- Reserve
- Reserve
- Reserve
- Reserve

			Datum	26.10.2012	EPLAN Software & Service Saia-Burgess Makroprojekt	Saia-Burgess Controls Ltd. Control Systems and Components	Saia-Burgess Controls Ltd.	SPS-Übersicht	= PCD3 Module	
			Bearb.	KAF					+ PCD3.E165	
			Gepr						Blatt	10
Änderung	Datum	Name	Urspr		Ersatz von	Ersetzt durch			Blatt	522

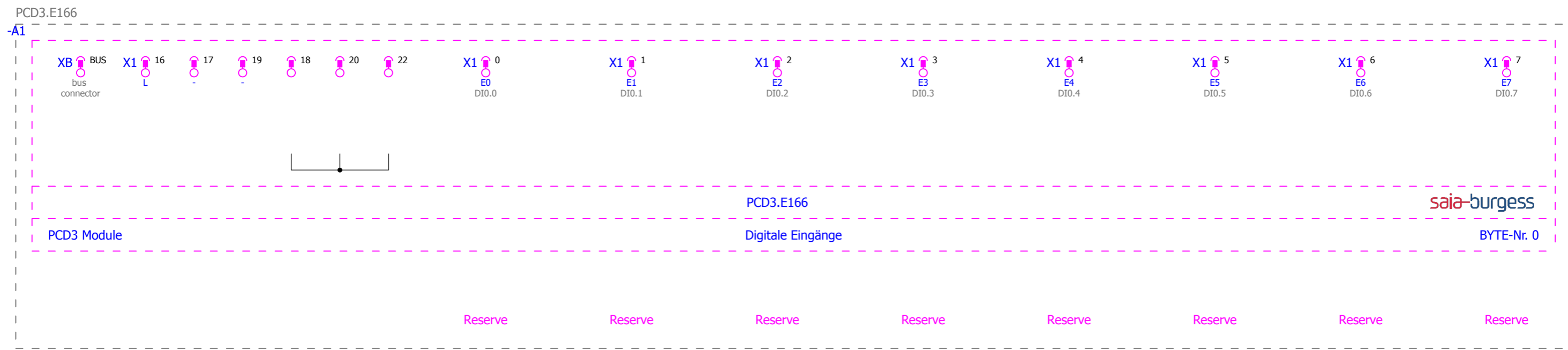

Saia-Burgess\PCD3 Module\PCD3.E166.ema
 Multi-line
 Variant A
 2012-10-26 / 2.1.4

+.E165/10

			Datum	26.10.2012	EPLAN Software & Service Saia-Burgess Makroprojekt	 Control Systems and Components	Saia-Burgess Controls Ltd.	Allpolig		= PCD3 Module		
			Bearb.	KAF							+ PCD3.E166	
			Gepr									
Änderung	Datum	Name	Urspr		Ersatz von	Ersetzt durch					Blatt 1	
											Blatt 522	

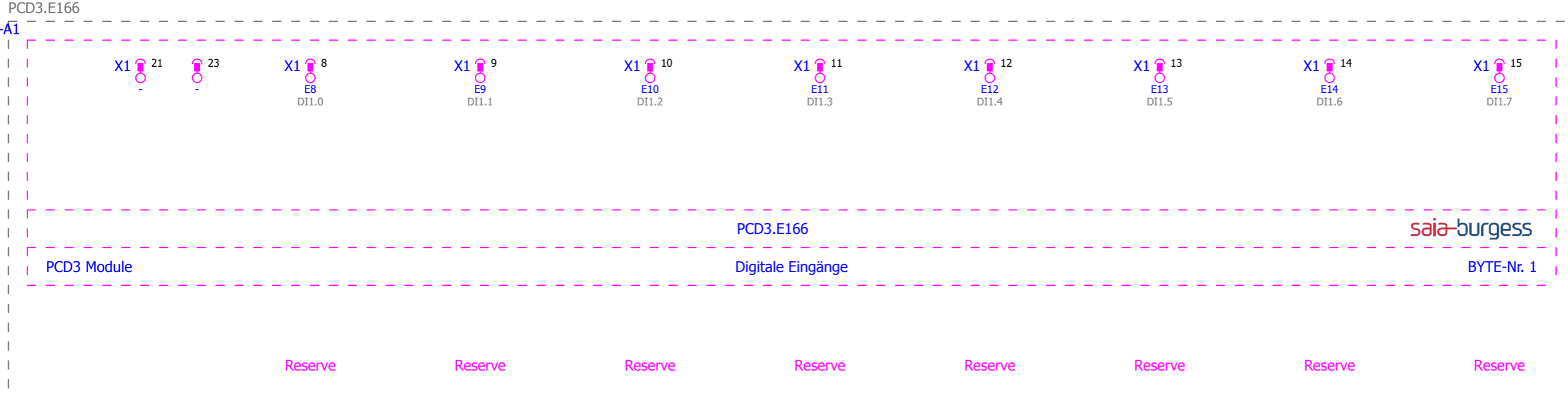

Saia-Burgess\PCD3 Module\PCD3.E166.ema
Multi-line
Variant B
2012-10-26 / 2.1.4



Saia-Burgess\PCD3 Module\PCD3.E166.ema
 Overview
 Variant A
 2012-10-26 / 2.1.4

bus connector

- Reserve
- Reserve
- Reserve
- Reserve
- Reserve
- Reserve
- Reserve
- Reserve
- Reserve
- Reserve

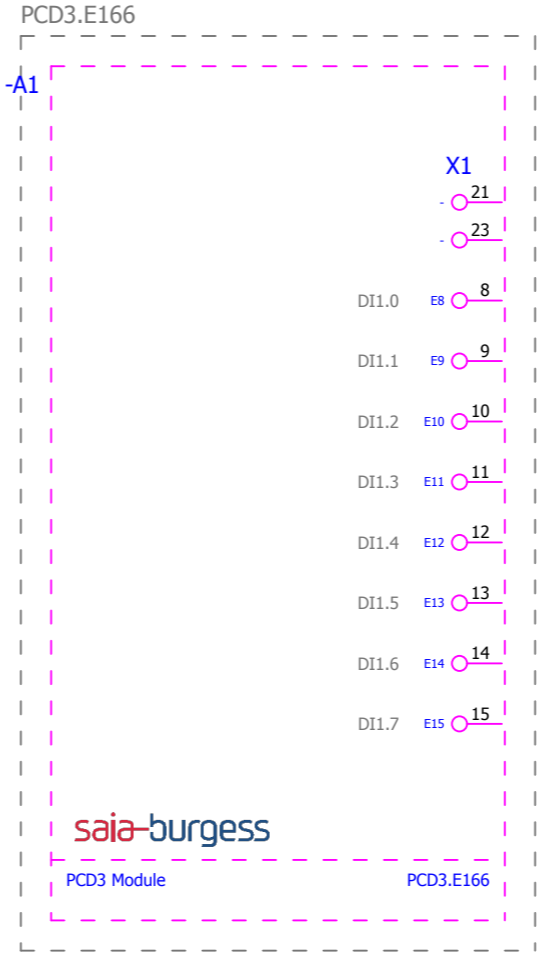

Saia-Burgess\PCD3 Module\PCD3.E166.ema
 Overview
 Variant B
 2012-10-26 / 2.1.4

- Reserve
- Reserve
- Reserve
- Reserve
- Reserve
- Reserve
- Reserve
- Reserve
- Reserve
- Reserve

			Datum	26.10.2012	EPLAN Software & Service Saia-Burgess Makroprojekt	Saia-Burgess Controls Ltd. Control Systems and Components	Saia-Burgess Controls Ltd.	SPS-Übersicht	= PCD3 Module		Blatt 10	
			Bearb.	KAF					+ PCD3.E166			Blatt 522
			Gepr									
Änderung	Datum	Name	Urspr		Ersatz von	Ersetzt durch						

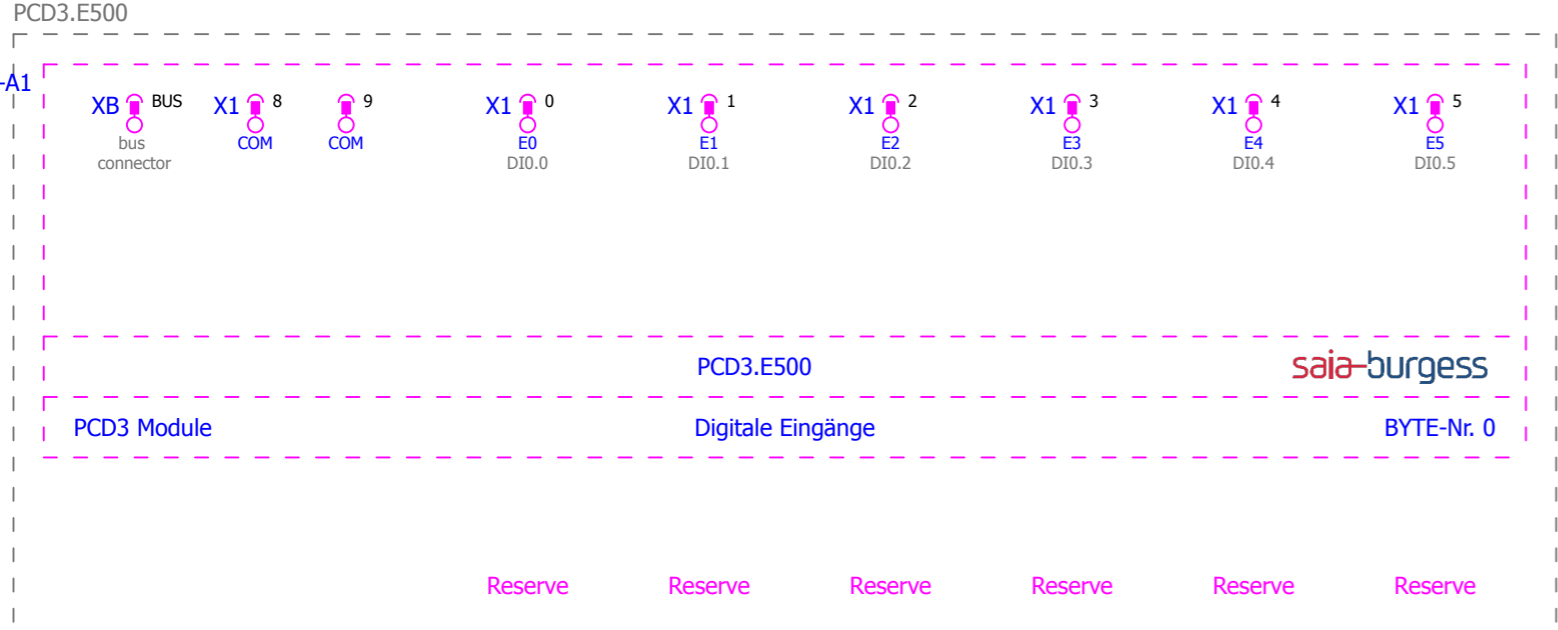

Saia-Burgess\PCD3 Module\PCD3.E500.ema
 Multi-line
 Variant A
 2012-10-26 / 2.1.4

+..E166/10

			Datum	26.10.2012	EPLAN Software & Service Saia-Burgess Makroprojekt	 Control Systems and Components	Saia-Burgess Controls Ltd.	Allpolig		= PCD3 Module			
			Bearb.	KAF							+ PCD3.E500		
			Gepr										Blatt
Änderung	Datum	Name	Urspr		Ersatz von	Ersetzt durch					Blatt	522	

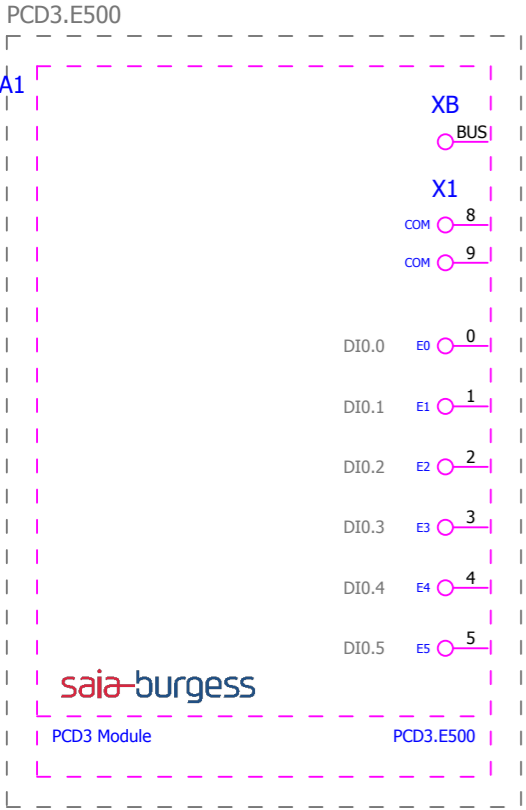

bus connector

Reserve

Reserve

Reserve

Reserve

Reserve

Reserve

Saia-Burgess\PCD3 Module\PCD3.E500.ema
 Overview
 Variant A
 2012-10-26 / 2.1.4

			Datum	26.10.2012	EPLAN Software & Service Saia-Burgess Makroprojekt	Saia-Burgess Controls Ltd. Control Systems and Components	Saia-Burgess Controls Ltd.	SPS-Übersicht	= PCD3 Module		Blatt 10
			Bearb.	KAF					+ PCD3.E500		
			Gepr								
Änderung	Datum	Name	Urspr		Ersatz von	Ersetzt durch				Blatt	522

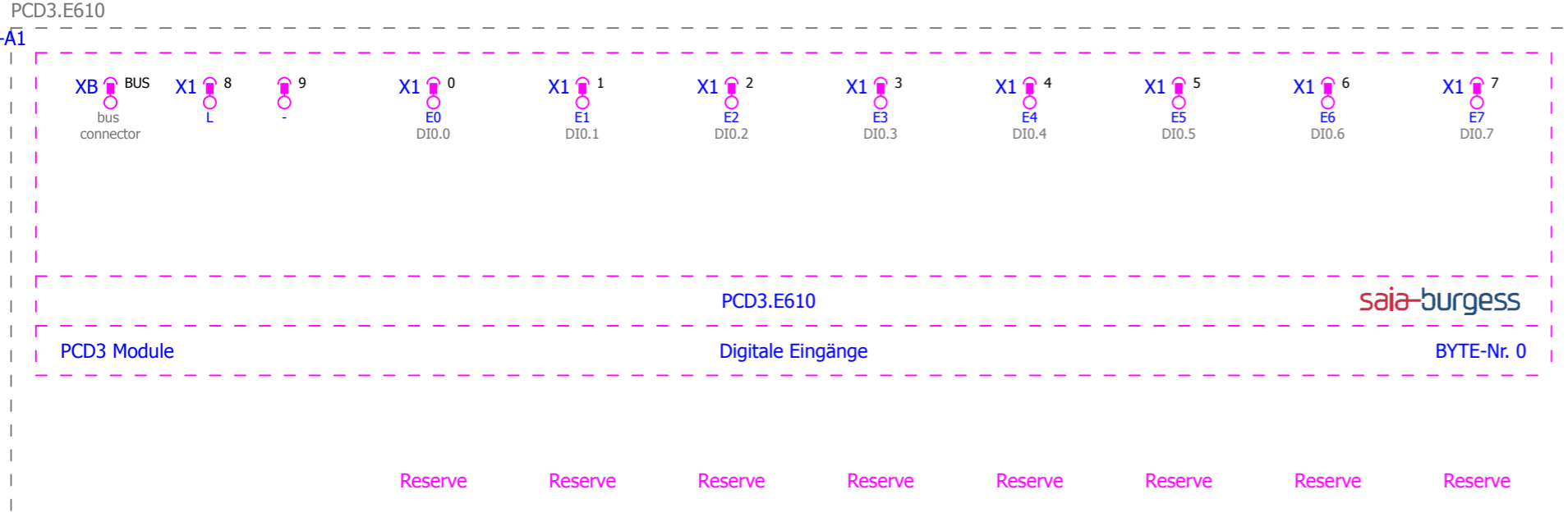

Saia-Burgess\PCD3 Module\PCD3.E610.ema
 Multi-line
 Variant A
 2012-10-26 / 2.1.4

+.E500/10

10

			Datum	26.10.2012	EPLAN Software & Service Saia-Burgess Makroprojekt	Saia-Burgess Controls Ltd. Control Systems and Components	Saia-Burgess Controls Ltd.	Allpolig	= PCD3 Module	
		Bearb.	KAF	+ PCD3.E610						
		Gepr		Blatt					1	
Änderung	Datum	Name	Urspr	Ersatz von	Ersetzt durch				Blatt	522

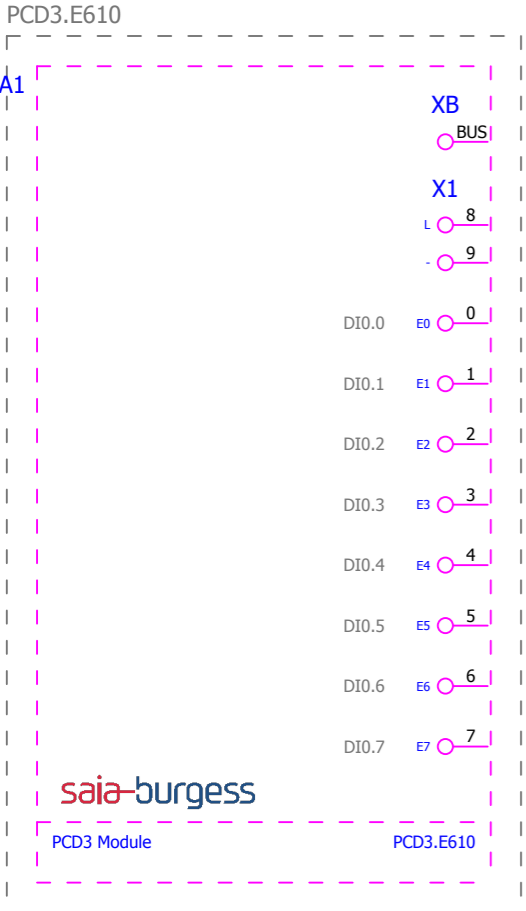

- bus connector
- Reserve
- Reserve
- Reserve
- Reserve
- Reserve
- Reserve
- Reserve

Saia-Burgess\PCD3 Module\PCD3.E610.ema
 Overview
 Variant A
 2012-10-26 / 2.1.4

			Datum	26.10.2012	EPLAN Software & Service Saia-Burgess Makroprojekt	Saia-Burgess Controls Ltd. Control Systems and Components	Saia-Burgess Controls Ltd.	SPS-Übersicht	= PCD3 Module		Blatt 10
		Bearb.	KAF	+ PCD3.E610							
		Gepr									
Änderung	Datum	Name	Urspr		Ersatz von	Ersetzt durch				Blatt	522

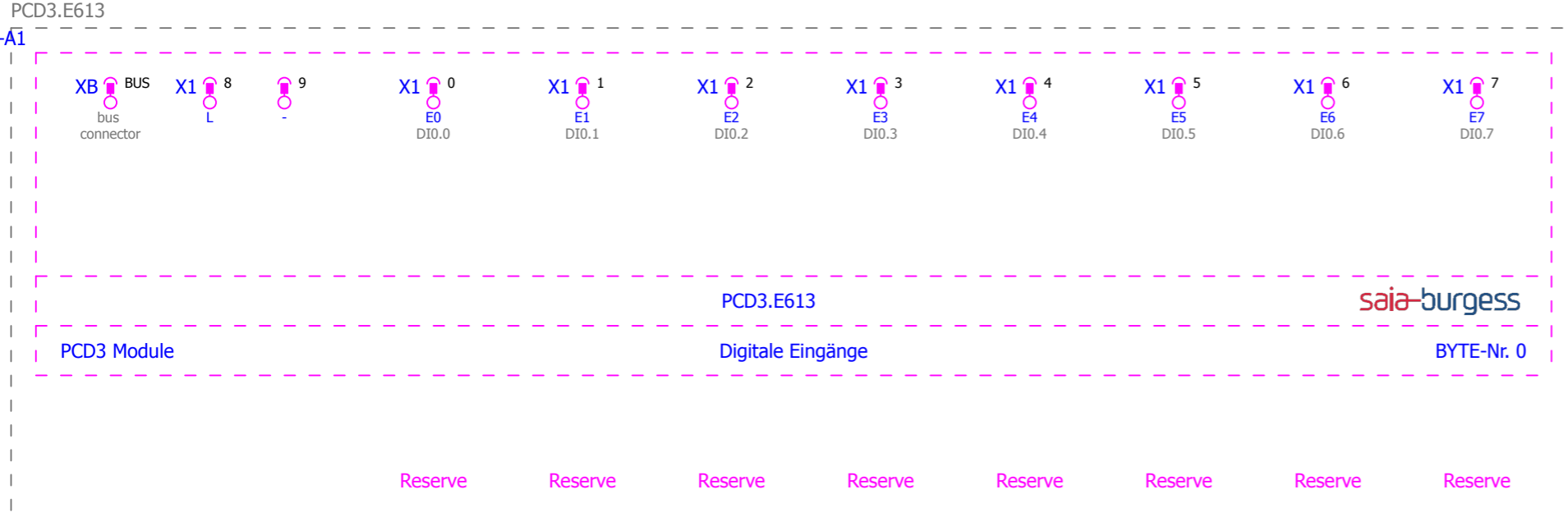

Saia-Burgess\PCD3 Module\PCD3.E613.ema
 Multi-line
 Variant A
 2012-10-26 / 2.1.4

+.E610/10			Datum 26.10.2012		EPLAN Software & Service Saia-Burgess Makroprojekt	Saia-Burgess Controls Ltd. Control Systems and Components	Allpolig	= PCD3 Module		Blatt 1	
			Bearb. KAF					+ PCD3.E613			Blatt 522
			Gepr								
Änderung	Datum	Name	Urspr	Ersatz von	Ersetzt durch						

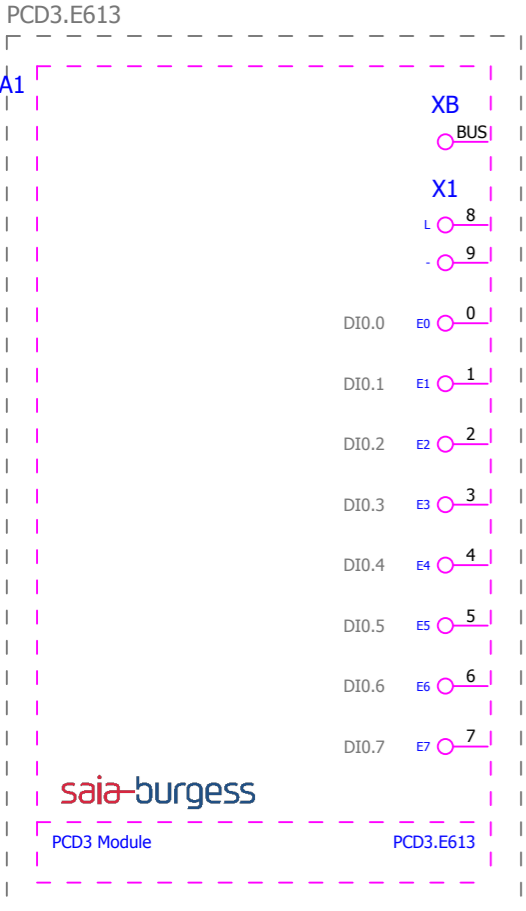

- bus connector
- Reserve
- Reserve
- Reserve
- Reserve
- Reserve
- Reserve
- Reserve
- Reserve

Saia-Burgess\PCD3 Module\PCD3.E613.ema
 Overview
 Variant A
 2012-10-26 / 2.1.4

			Datum	26.10.2012	EPLAN Software & Service Saia-Burgess Makroprojekt	Saia-Burgess Controls Ltd. Control Systems and Components	Saia-Burgess Controls Ltd.	SPS-Übersicht	= PCD3 Module		Blatt 10
			Bearb.	KAF					+ PCD3.E613		
			Gepr								
Änderung	Datum	Name	Urspr		Ersatz von	Ersetzt durch					

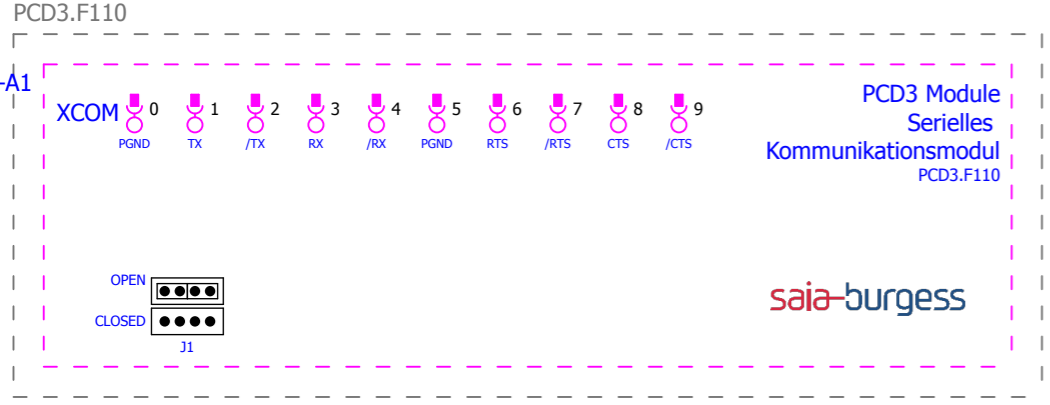

Saia-Burgess\PCD3 Module\PCD3.F110.ema
 Multi-line
 Variant A
 2012-10-26 / 2.1.4

			Datum	26.10.2012	EPLAN Software & Service Saia-Burgess Makroprojekt	Saia-Burgess Controls Ltd. Control Systems and Components	Saia-Burgess Controls Ltd.	Allpolig	= PCD3 Module		Blatt 1
		Bearb.	KAF	+ PCD3.F110							
		Gepr									
Änderung	Datum	Name	Urspr	Ersatz von	Ersetzt durch					Blatt	522

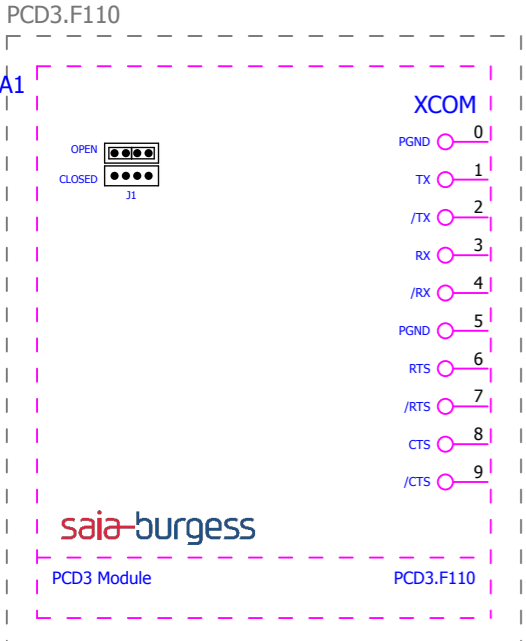

Saia-Burgess\PCD3 Module\PCD3.F110.ema
 Overview
 Variant A
 2012-10-26 / 2.1.4

			Datum	26.10.2012	EPLAN Software & Service Saia-Burgess Makroprojekt	Saia-Burgess Controls Ltd. <small>Control Systems and Components</small>	Saia-Burgess Controls Ltd.	SPS-Übersicht	= PCD3 Module		Blatt 10
		Bearb.	KAF	+ PCD3.F110							
		Gepr								Blatt 522	
Änderung	Datum	Name	Urspr		Ersatz von	Ersetzt durch					

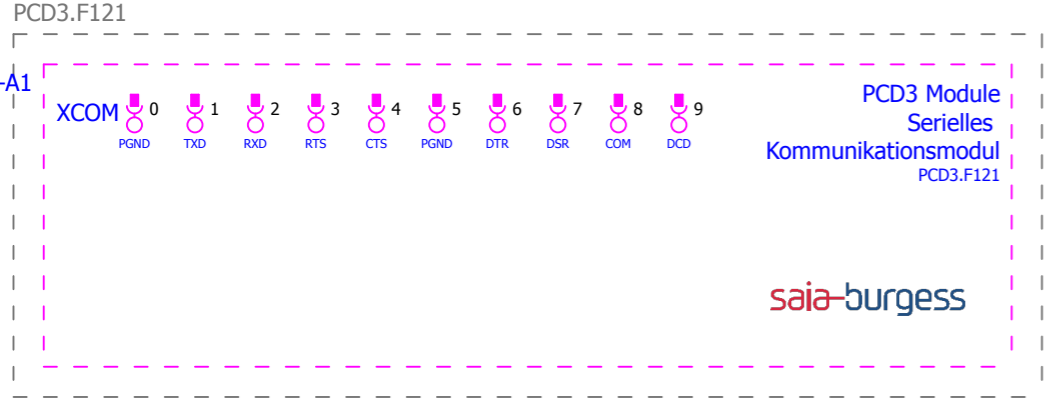

Saia-Burgess\PCD3 Module\PCD3.F121.ema
 Multi-line
 Variant A
 2012-10-26 / 2.1.4

			Datum	26.10.2012	EPLAN Software & Service Saia-Burgess Makroprojekt	Saia-Burgess Controls Ltd. Control Systems and Components	Saia-Burgess Controls Ltd.	Allpolig	= PCD3 Module	
			Bearb.	KAF					+ PCD3.F121	
			Gepr						Blatt	1
Änderung	Datum	Name	Urspr		Ersatz von	Ersetzt durch			Blatt	522

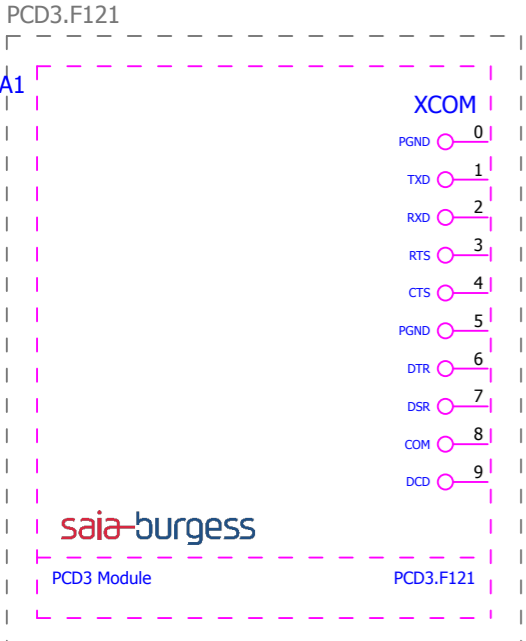

Saia-Burgess\PCD3 Module\PCD3.F121.ema
 Overview
 Variant A
 2012-10-26 / 2.1.4

			Datum	26.10.2012	EPLAN Software & Service Saia-Burgess Makroprojekt	Saia-Burgess Controls Ltd. Control Systems and Components	Saia-Burgess Controls Ltd.	SPS-Übersicht	= PCD3 Module		Blatt 10	
			Bearb.	KAF					+ PCD3.F121			Blatt 522
			Gepr									
Änderung	Datum	Name	Urspr		Ersatz von	Ersetzt durch						

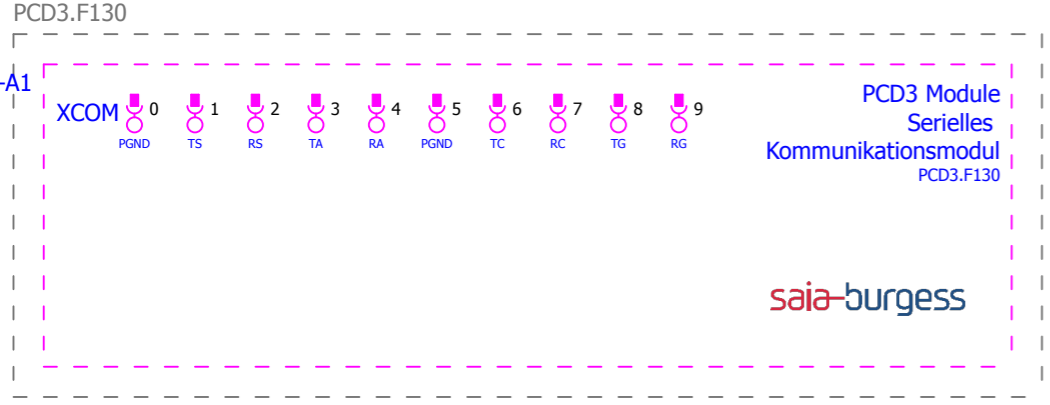

Saia-Burgess\PCD3 Module\PCD3.F130.ema
 Multi-line
 Variant A
 2012-10-26 / 2.1.4

			Datum	26.10.2012	EPLAN Software & Service Saia-Burgess Makroprojekt	Saia-Burgess Controls Ltd. Control Systems and Components	Saia-Burgess Controls Ltd.	Allpolig	= PCD3 Module	
			Bearb.	KAF					+ PCD3.F130	
			Gepr						Blatt	1
Änderung	Datum	Name	Urspr		Ersatz von	Ersetzt durch			Blatt	522

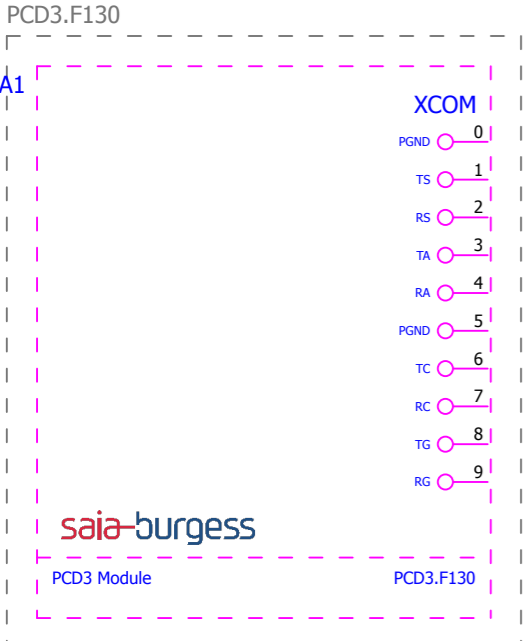

Saia-Burgess\PCD3 Module\PCD3.F130.ema
 Overview
 Variant A
 2012-10-26 / 2.1.4

			Datum	26.10.2012	EPLAN Software & Service Saia-Burgess Makroprojekt	Saia-Burgess Controls Ltd. Control Systems and Components	Saia-Burgess Controls Ltd.	SPS-Übersicht	= PCD3 Module		Blatt 10
		Bearb.	KAF	+ PCD3.F130							
		Gepr									
Änderung	Datum	Name	Urspr		Ersatz von	Ersetzt durch				Blatt 522	

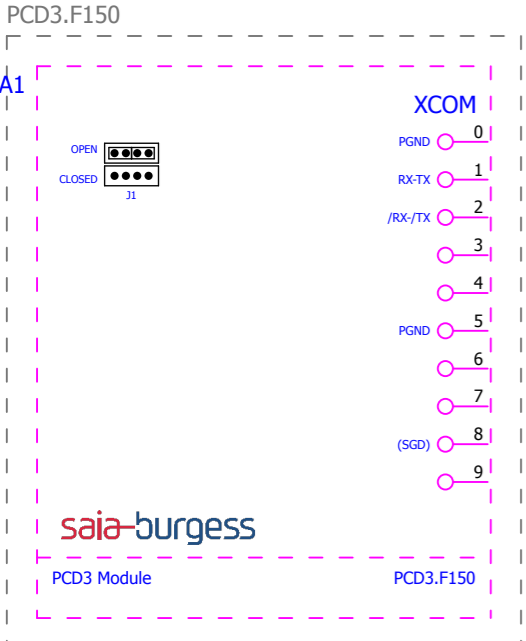

Saia-Burgess\PCD3 Module\PCD3.F150.ema
 Overview
 Variant A
 2012-10-26 / 2.1.4

			Datum	26.10.2012	EPLAN Software & Service Saia-Burgess Makroprojekt	Saia-Burgess Controls Ltd. Control Systems and Components	Saia-Burgess Controls Ltd.	SPS-Übersicht	= PCD3 Module		Blatt 10
		Bearb.	KAF	+ PCD3.F150							
		Gepr									
Änderung	Datum	Name	Ürspr		Ersatz von	Ersetzt durch				Blatt	522

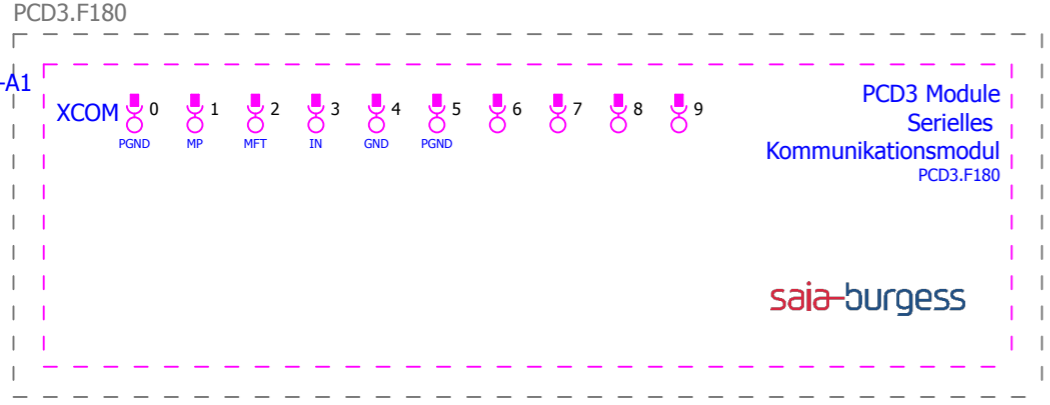

Saia-Burgess\PCD3 Module\PCD3.F180.ema
 Multi-line
 Variant A
 2012-10-26 / 2.1.4

			Datum	26.10.2012	EPLAN Software & Service Saia-Burgess Makroprojekt	Saia-Burgess Controls Ltd. Control Systems and Components	Saia-Burgess Controls Ltd.	Allpolig	= PCD3 Module	
		Bearb.	KAF	+ PCD3.F180						
		Gepr		Blatt					1	
Änderung	Datum	Name	Urspr	Ersatz von	Ersetzt durch				Blatt	522

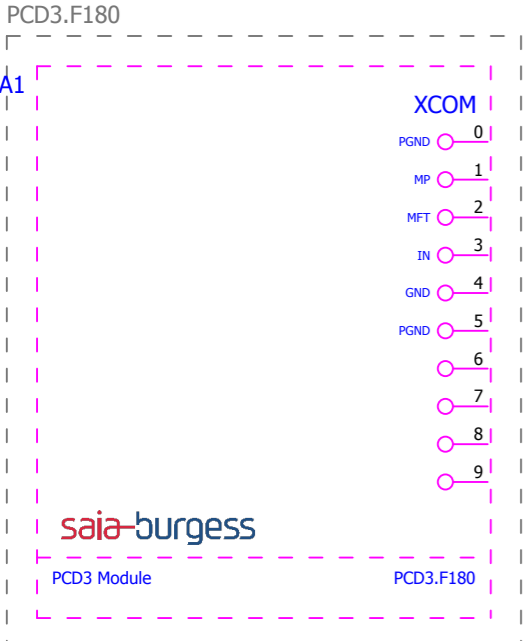

Saia-Burgess\PCD3 Module\PCD3.F180.ema
 Overview
 Variant A
 2012-10-26 / 2.1.4

			Datum	26.10.2012	EPLAN Software & Service Saia-Burgess Makroprojekt	Saia-Burgess Controls Ltd. <small>Control Systems and Components</small>	Saia-Burgess Controls Ltd.	SPS-Übersicht	= PCD3 Module		Blatt 10
		Bearb.	KAF	+ PCD3.F180							
		Gepr									
Änderung	Datum	Name	Urspr		Ersatz von	Ersetzt durch				Blatt	522

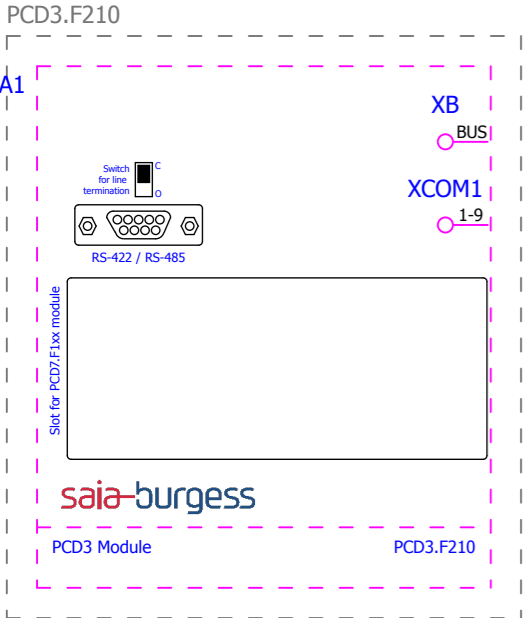

bus connector

Saia-Burgess\PCD3 Module\PCD3.F210.ema
 Overview
 Variant A
 2012-10-26 / 2.1.4

			Datum	26.10.2012	EPLAN Software & Service Saia-Burgess Makroprojekt	Saia-Burgess Controls Ltd. Control Systems and Components	Saia-Burgess Controls Ltd.	SPS-Übersicht	= PCD3 Module		Blatt 10
		Bearb.	KAF	+ PCD3.F210							
		Gepr									
Änderung	Datum	Name	Ürspr		Ersatz von	Ersetzt durch				Blatt 522	

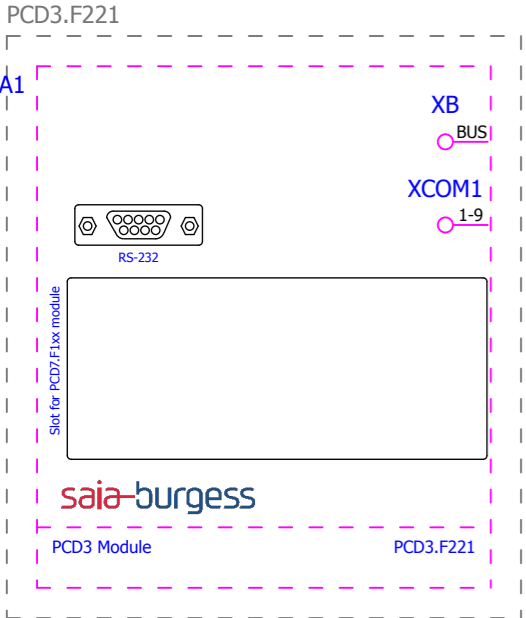

bus connector

Saia-Burgess\PCD3 Module\PCD3.F221.ema
 Overview
 Variant A
 2012-10-26 / 2.1.4

			Datum	26.10.2012	EPLAN Software & Service Saia-Burgess Makroprojekt	Saia-Burgess Controls Ltd. Control Systems and Components	Saia-Burgess Controls Ltd.	SPS-Übersicht	= PCD3 Module		Blatt 10
		Bearb.	KAF	+ PCD3.F221							
		Gepr									
Änderung	Datum	Name	Ürspr		Ersatz von	Ersetzt durch				Blatt	522

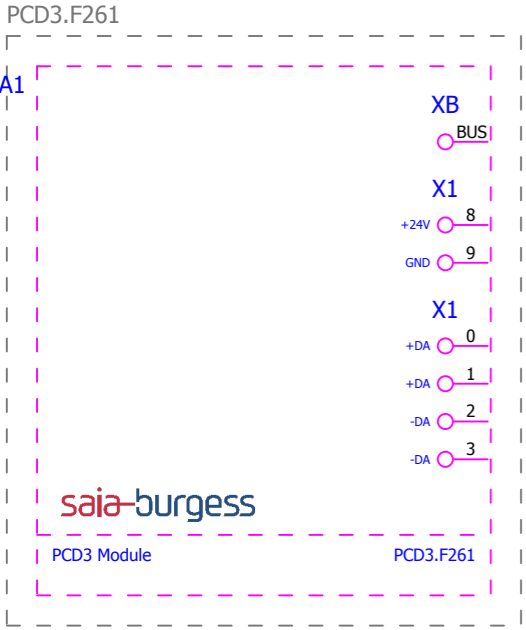

bus connector

Saia-Burgess\PCD3 Module\PCD3.F261.ema
 Overview
 Variant A
 2012-10-26 / 2.1.4

			Datum	26.10.2012	EPLAN Software & Service Saia-Burgess Makroprojekt	Saia-Burgess Controls Ltd. Control Systems and Components	Saia-Burgess Controls Ltd.	SPS-Übersicht	= PCD3 Module		Blatt 10
		Bearb.	KAF	+ PCD3.F261							
		Gepr									
Änderung	Datum	Name	Urspr		Ersatz von	Ersetzt durch				Blatt 522	

PCD3.F270

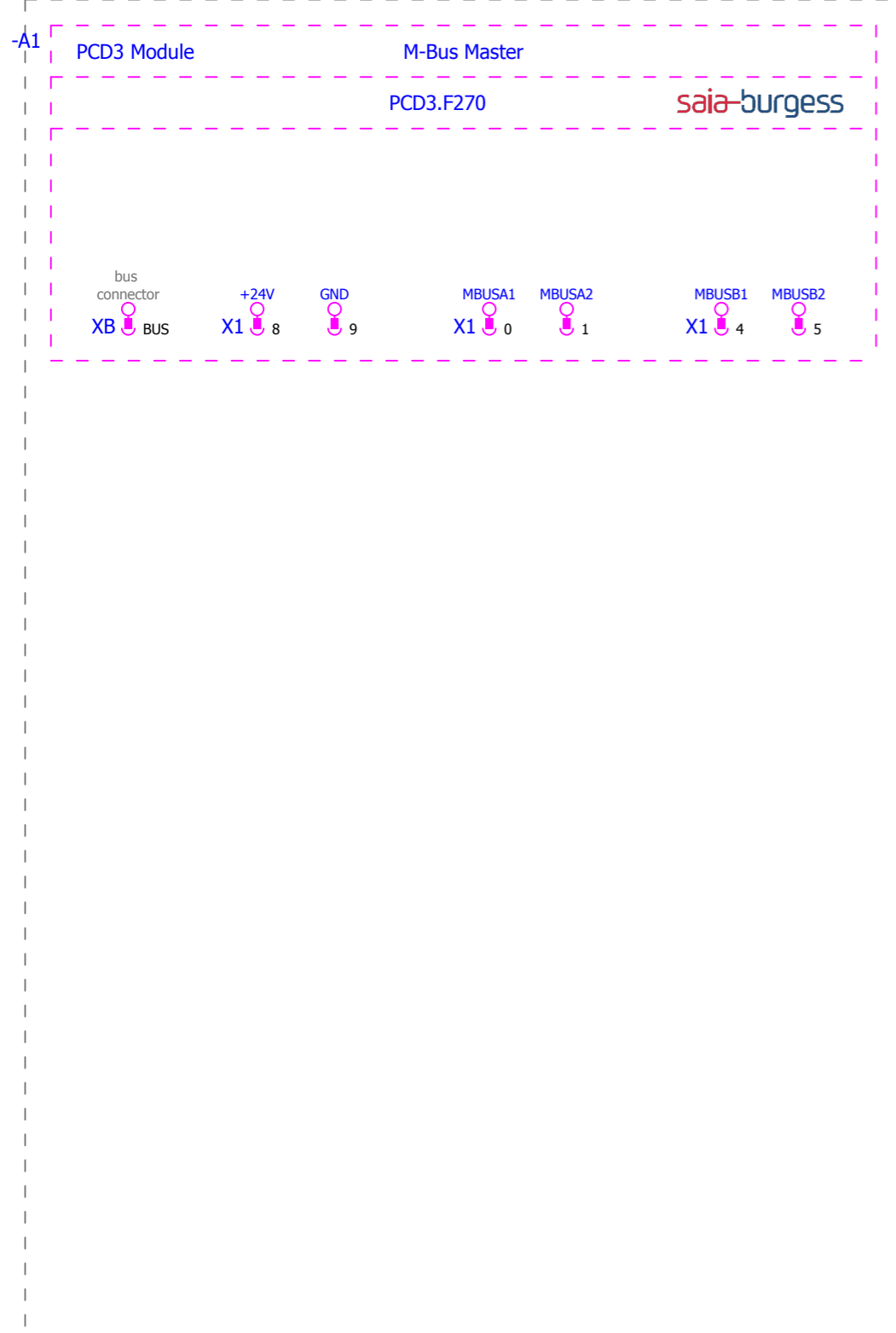

Saia-Burgess\PCD3 Module\PCD3.F270.ema
 Multi-line
 Variant A
 2012-10-26 / 2.1.4

+.F261/10

10

			Datum	26.10.2012	EPLAN Software & Service Saia-Burgess Makroprojekt	Saia-Burgess Controls Ltd. <small>Control Systems and Components</small>	Allpolig	= PCD3 Module		
		Bearb.	KAF	+ PCD3.F270						
		Gepr						Blatt	1	
Änderung	Datum	Name	Urspr	Ersatz von	Ersetzt durch				Blatt	522

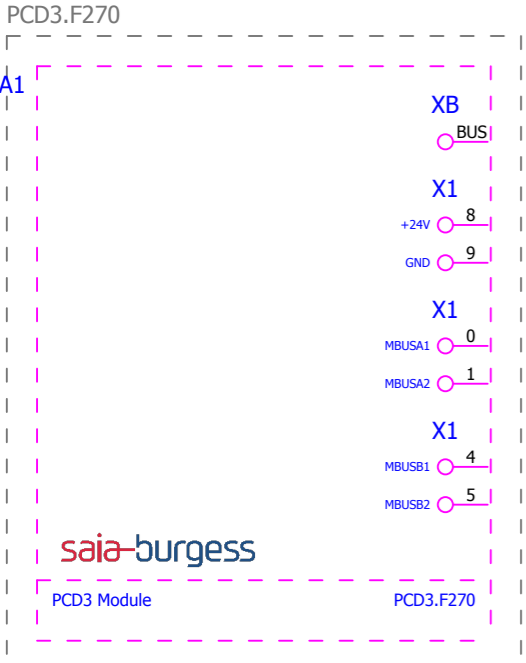

bus connector

Saia-Burgess\PCD3 Module\PCD3.F270.ema
 Overview
 Variant A
 2012-10-26 / 2.1.4

			Datum	26.10.2012	EPLAN Software & Service Saia-Burgess Makroprojekt	Saia-Burgess Controls Ltd. Control Systems and Components	Saia-Burgess Controls Ltd.	SPS-Übersicht	= PCD3 Module		Blatt 10
		Bearb.	KAF	+ PCD3.F270							
		Gepr									
Änderung	Datum	Name	Urspr		Ersatz von	Ersetzt durch				Blatt	522

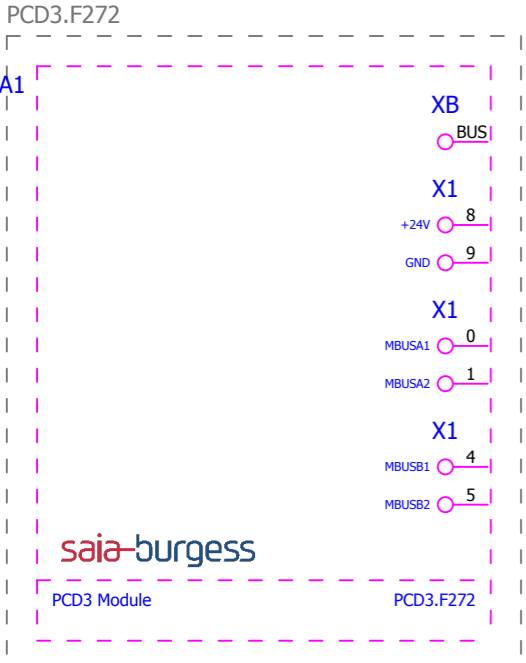

Saia-Burgess\PCD3 Module\PCD3.F272.ema
 Overview
 Variant A
 2012-10-26 / 2.1.4

			Datum	26.10.2012	EPLAN Software & Service Saia-Burgess Makroprojekt <small>Control Systems and Components</small>	Saia-Burgess Controls Ltd.	SPS-Übersicht	= PCD3 Module		
		Bearb.	KAF	+ PCD3.F272						
		Gepr						Blatt	10	
Änderung	Datum	Name	Urspr		Ersatz von	Ersetzt durch			Blatt	522

PCD3.F273

-A1

PCD3 Module

M-Bus Master

PCD3.F273

saia-burgess



Saia-Burgess\PCD3 Module\PCD3.F273.ema
Multi-line
Variant A
2012-10-26 / 2.1.4

+.F272/10

10

			Datum	26.10.2012	EPLAN Software & Service Saia-Burgess Makroprojekt	Saia-Burgess Controls Ltd. Control Systems and Components	Saia-Burgess Controls Ltd.	Allpolig	= PCD3 Module		Blatt 1
		Bearb.	KAF	+ PCD3.F273							
		Gepr									
Änderung	Datum	Name	Urspr		Ersatz von	Ersetzt durch				Blatt 522	

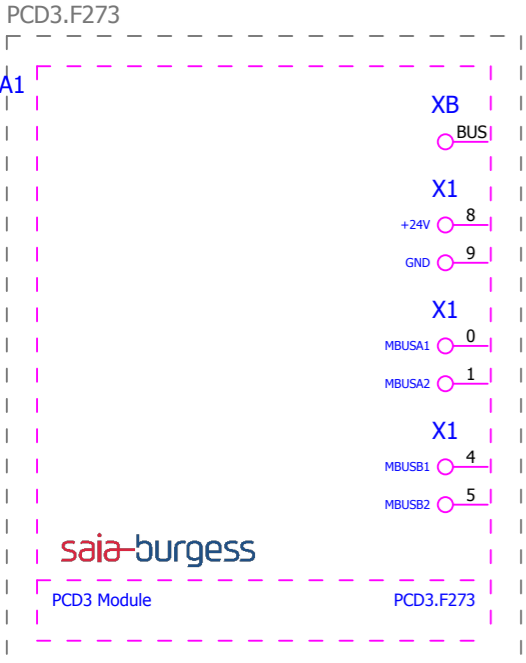

Saia-Burgess\PCD3 Module\PCD3.F273.ema
 Overview
 Variant A
 2012-10-26 / 2.1.4

			Datum	26.10.2012	EPLAN Software & Service Saia-Burgess Makroprojekt	Saia-Burgess Controls Ltd. Control Systems and Components	Saia-Burgess Controls Ltd.	SPS-Übersicht	= PCD3 Module		Blatt 10
		Bearb.	KAF	+ PCD3.F273							
		Gepr									
Änderung	Datum	Name	Urspr		Ersatz von	Ersetzt durch				Blatt	522

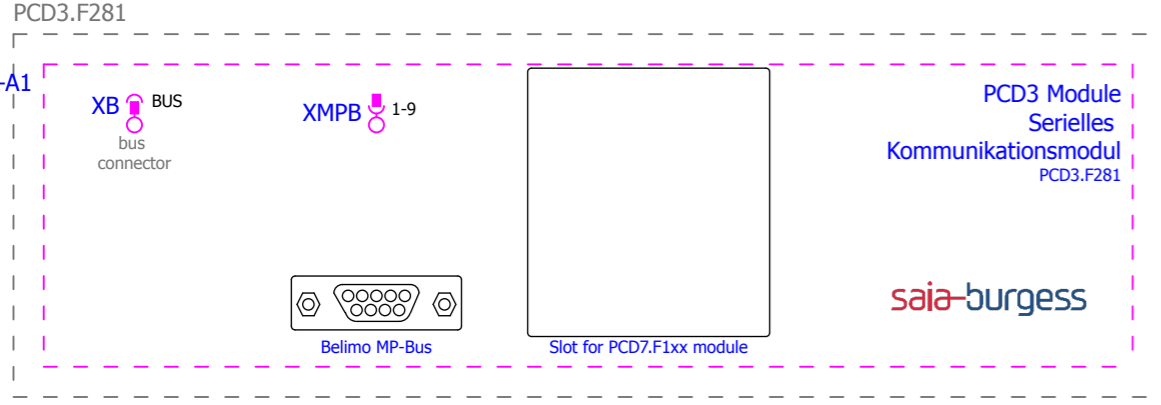

Saia-Burgess\PCD3 Module\PCD3.F281.ema
 Multi-line
 Variant A
 2012-10-26 / 2.1.4

			Datum	26.10.2012	 EPLAN Software & Service  Saia-Burgess Makroprojekt	 Saia-Burgess Controls Ltd. Control Systems and Components	Saia-Burgess Controls Ltd.	Allpolig	= PCD3 Module		Blatt 1
		Bearb.	KAF	+ PCD3.F281							
		Gepr									
Änderung	Datum	Name	Urspr		Ersatz von	Ersetzt durch				Blatt 522	

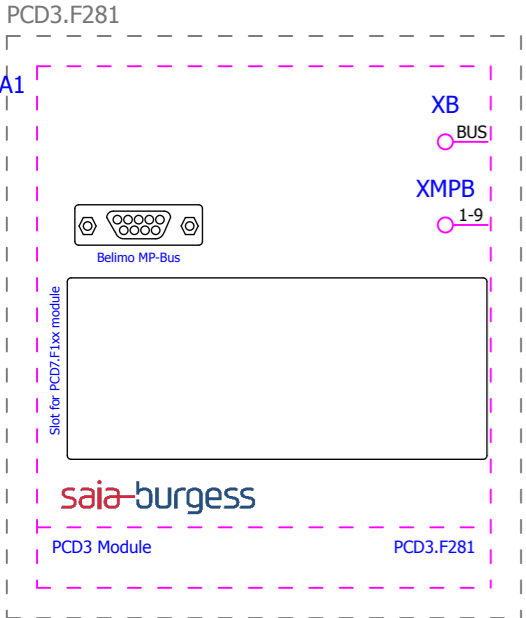

bus connector

Saia-Burgess\PCD3 Module\PCD3.F281.ema
 Overview
 Variant A
 2012-10-26 / 2.1.4

			Datum	26.10.2012	EPLAN Software & Service Saia-Burgess Makroprojekt	Saia-Burgess Controls Ltd. Control Systems and Components	Saia-Burgess Controls Ltd.	SPS-Übersicht	= PCD3 Module		Blatt 10
		Bearb.	KAF	+ PCD3.F281							
		Gepr									
Änderung	Datum	Name	Urspr		Ersatz von	Ersetzt durch				Blatt	522

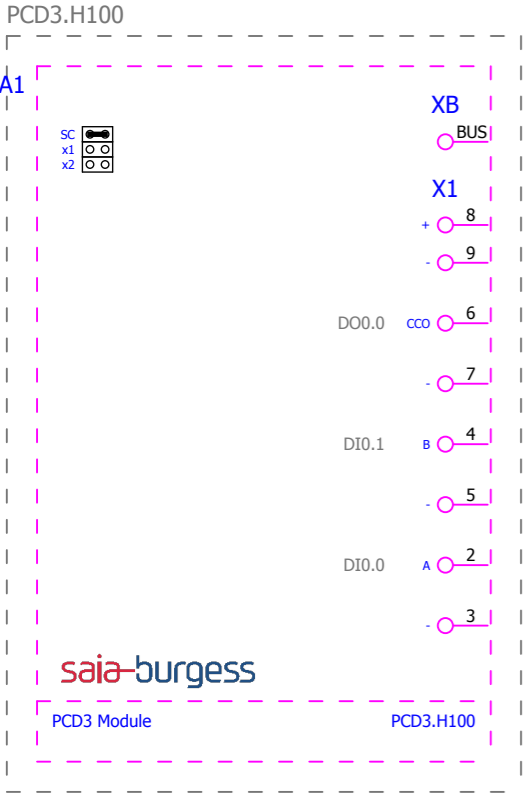

bus connector

Reserve

Reserve

Reserve

Saia-Burgess\PCD3 Module\PCD3.H100.ema
 Overview
 Variant A
 2012-10-26 / 2.1.4

			Datum	26.10.2012	EPLAN Software & Service Saia-Burgess Makroprojekt	Saia-Burgess Controls Ltd. Control Systems and Components	Saia-Burgess Controls Ltd.	SPS-Übersicht	= PCD3 Module		Blatt 10
		Bearb.	KAF	+ PCD3.H100							
		Gepr									
Änderung	Datum	Name	Urspr		Ersatz von	Ersetzt durch				Blatt	522

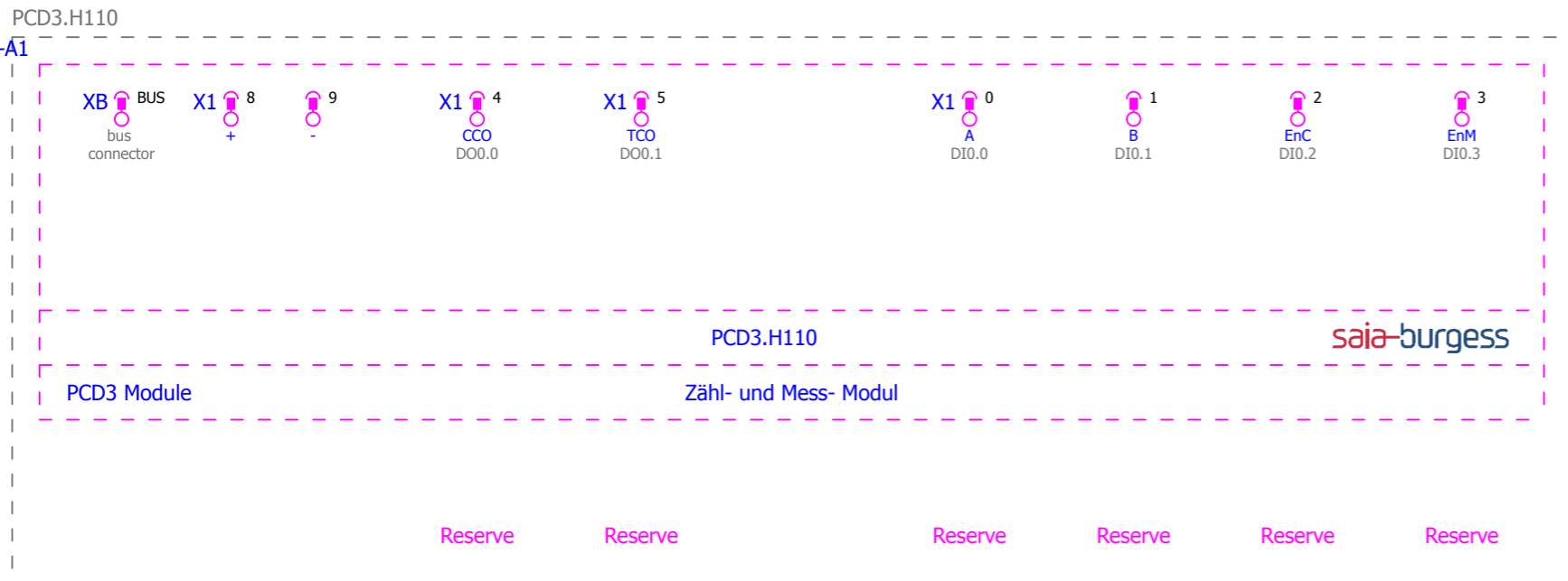

Saia-Burgess\PCD3 Module\PCD3.H110.ema
 Multi-line
 Variant A
 2012-10-26 / 2.1.4

			Datum 26.10.2012		EPLAN Software & Service Saia-Burgess Makroprojekt	Saia-Burgess Controls Ltd. Control Systems and Components	Allpolig	= PCD3 Module		Blatt 1	
			Bearb. KAF					+ PCD3.H110			Blatt 522
			Gepr.								
Änderung	Datum	Name	Urspr	Ersatz von	Ersetzt durch						



Saia-Burgess\PCD3 Module\PCD3.H110.ema
 Overview
 Variant A
 2012-10-26 / 2.1.4

bus connector

 Reserve
 Reserve
 Reserve
 Reserve
 Reserve
 Reserve

			Datum	26.10.2012	EPLAN Software & Service Saia-Burgess Makroprojekt	Saia-Burgess Controls Ltd. Control Systems and Components	Saia-Burgess Controls Ltd.	SPS-Übersicht	= PCD3 Module		Blatt 10
			Bearb.	KAF					+ PCD3.H110		
			Gepr								
Änderung	Datum	Name	Urspr		Ersatz von	Ersetzt durch				Blatt	522

PCD3.H112

-A1

PCD3 Module

Schnelles Zählermodul

PCD3.H112

saia-burgess

bus connector

XB BUS

CTR_0_A

CTR_0_B

CTR_0_C

CCO_0

CTR_1_A

CTR_1_B

CTR_1_C

CCO_1

GND

+24V

X0 0

1

2

3

4

5

6

7

8

9

Saia-Burgess\PCD3 Module\PCD3.H112.ema

Multi-line

Variant A

2012-10-26 / 2.1.4

+.H110/10

10

			Datum	26.10.2012	 EPLAN Software & Service  Saia-Burgess Makroprojekt	 Saia-Burgess Controls Ltd. <small>Control Systems and Components</small>	Saia-Burgess Controls Ltd.	Allpolig	= PCD3 Module		Blatt 1
		Bearb.	KAF	+ PCD3.H112							
		Gepr									
Änderung	Datum	Name	Urspr		Ersatz von	Ersetzt durch				Blatt 522	

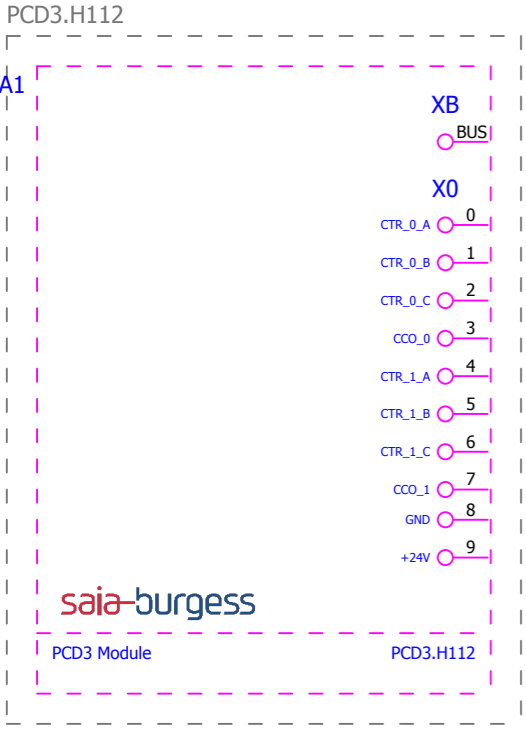

bus connector

Saia-Burgess\PCD3 Module\PCD3.H112.ema
 Overview
 Variant A
 2012-10-26 / 2.1.4

			Datum	26.10.2012	EPLAN Software & Service Saia-Burgess Makroprojekt	Saia-Burgess Controls Ltd. Control Systems and Components	Saia-Burgess Controls Ltd.	SPS-Übersicht	= PCD3 Module		Blatt 10
		Bearb.	KAF	+ PCD3.H112							
		Gepr									
Änderung	Datum	Name	Üspr		Ersatz von	Ersetzt durch				Blatt	522



Saia-Burgess\PCD3 Module\PCD3.H114.ema
 Multi-line
 Variant A
 2012-10-26 / 2.1.4

			Saia-Burgess\PCD3 Module\PCD3.H114.ema		EPLAN Software & Service		Saia-Burgess Controls Ltd.		Allpolig		= PCD3 Module	
			Multi-line		EPLAN Saia-Burgess Makroprojekt		Ltd.				+ PCD3.H114	
			Variant A		Ersatz von						Blatt 1	
			2012-10-26 / 2.1.4		Ersetzt durch						Blatt 522	
+.H112/10												



Saia-Burgess\PCD3 Module\PCD3.H150.ema
 Multi-line
 Variant A
 2012-10-26 / 2.1.4

+.H114/10

10

			Datum	26.10.2012	EPLAN Software & Service Saia-Burgess Makroprojekt	 Control Systems and Components	Saia-Burgess Controls Ltd.	Allpolig	= PCD3 Module		Blatt 1
		Bearb.	KAF	+ PCD3.H150							
		Gepr									
Änderung	Datum	Name	Urspr	Ersatz von	Ersetzt durch					Blatt 522	

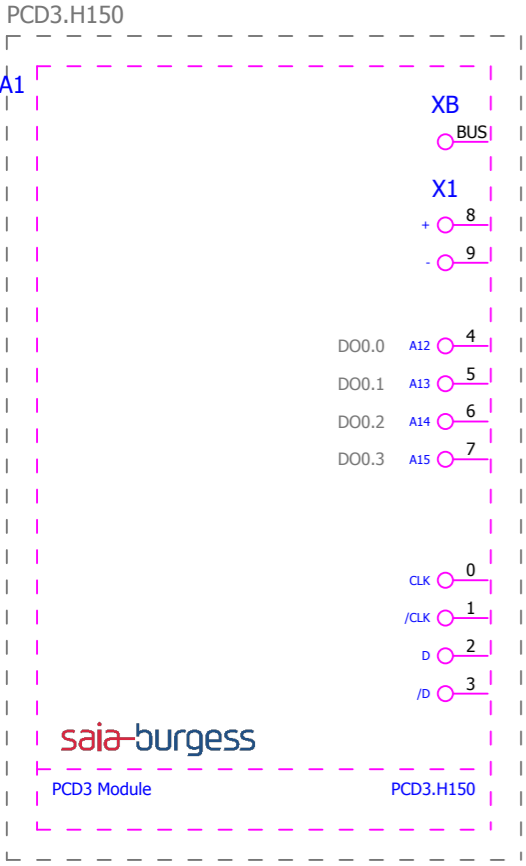

bus connector
 24V DC
 Reserve
 Reserve
 Reserve
 Reserve

Saia-Burgess\PCD3 Module\PCD3.H150.ema
 Overview
 Variant A
 2012-10-26 / 2.1.4

			Datum	26.10.2012	EPLAN Software & Service Saia-Burgess Makroprojekt	Saia-Burgess Controls Ltd. Control Systems and Components	Saia-Burgess Controls Ltd.	SPS-Übersicht	= PCD3 Module		Blatt 10
			Bearb.	KAF					+ PCD3.H150		
			Gepr								
Änderung	Datum	Name	Urspr		Ersatz von	Ersetzt durch					

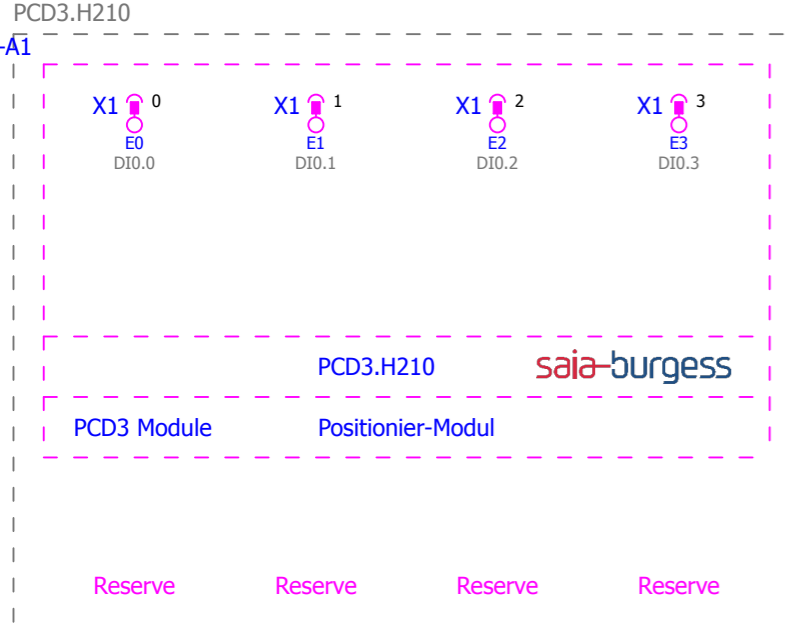

Saia-Burgess\PCD3 Module\PCD3.H210.ema
 Multi-line
 Variant B
 2012-10-26 / 2.1.4

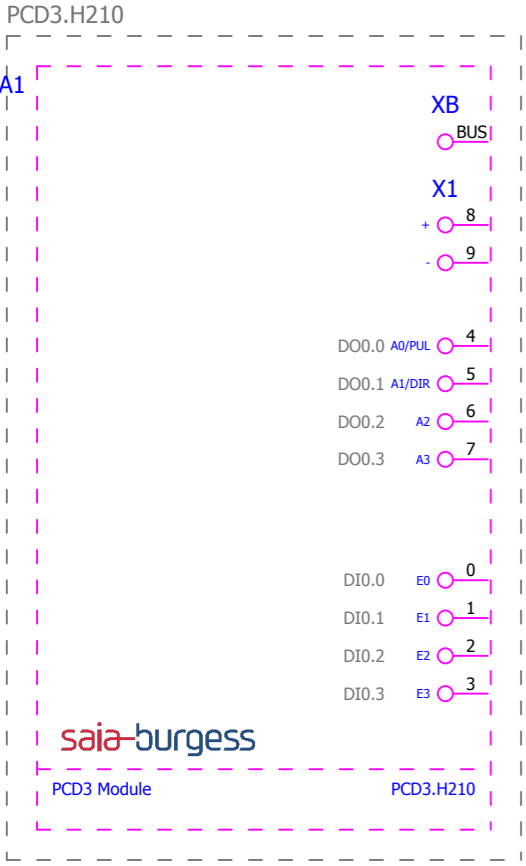

bus connector

24V DC

Reserve

Reserve

Reserve

Reserve

Reserve

Reserve

Reserve

Reserve

Reserve

Saia-Burgess\PCD3 Module\PCD3.H210.ema
 Overview
 Variant A
 2012-10-26 / 2.1.4

			Datum	26.10.2012	EPLAN Software & Service Saia-Burgess Makroprojekt	Saia-Burgess Controls Ltd. Control Systems and Components	Saia-Burgess Controls Ltd.	SPS-Übersicht	= PCD3 Module		Blatt 10
			Bearb.	KAF					+ PCD3.H210		
			Gepr								
Änderung	Datum	Name	Urspr		Ersatz von	Ersetzt durch				Blatt	522

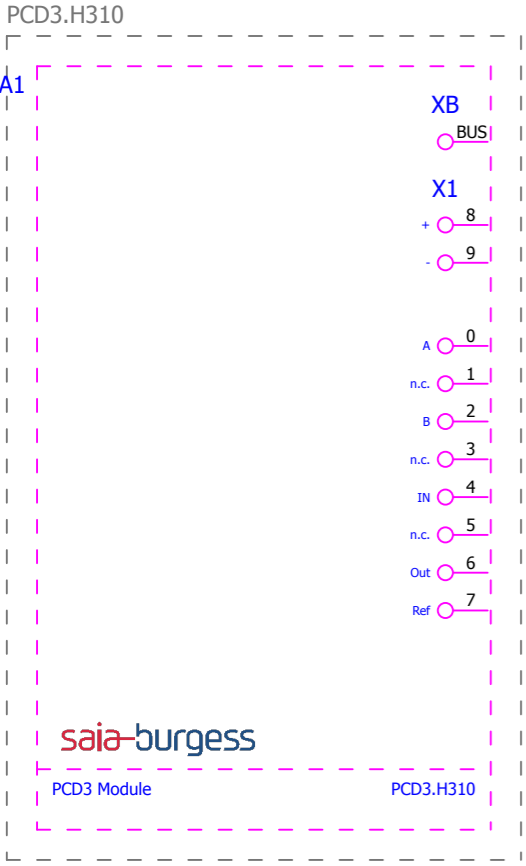

bus connector

24V DC

Saia-Burgess\PCD3 Module\PCD3.H310.ema
 Overview
 Variant A
 2012-10-26 / 2.1.4

			Datum	26.10.2012	EPLAN Software & Service Saia-Burgess Makroprojekt	Saia-Burgess Controls Ltd. Control Systems and Components	Saia-Burgess Controls Ltd.	SPS-Übersicht	= PCD3 Module		Blatt 10
		Bearb.	KAF	+ PCD3.H310							
		Gepr									
Änderung	Datum	Name	Urspr		Ersatz von	Ersetzt durch				Blatt	522

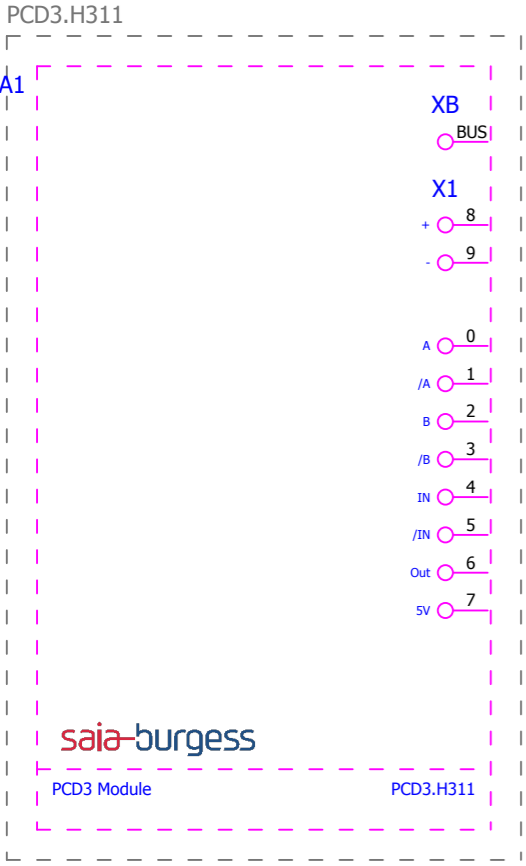

bus connector

24V DC

Saia-Burgess\PCD3 Module\PCD3.H311.ema
 Overview
 Variant A
 2012-10-26 / 2.1.4

			Datum	26.10.2012	EPLAN Software & Service Saia-Burgess Makroprojekt	Saia-Burgess Controls Ltd. Control Systems and Components	Saia-Burgess Controls Ltd.	SPS-Übersicht	= PCD3 Module		Blatt 10
		Bearb.	KAF	+ PCD3.H311							
		Gepr									
Änderung	Datum	Name	Urspr		Ersatz von	Ersetzt durch				Blatt 522	



Saia-Burgess\PCD3 Module\PCD3.H222.ema
 Multi-line
 Variant A
 2012-10-26 / 2.1.4

+.H311/10

			Datum	26.10.2012	EPLAN Software & Service Saia-Burgess Makroprojekt	Saia-Burgess Controls Ltd. <small>Control Systems and Components</small>	Allpolig	= PCD3 Module	
		Bearb.	KAF	+ PCD3.H222					
		Gepr		Blatt				1	
Änderung	Datum	Name	Urspr	Ersatz von	Ersetzt durch			Blatt	522

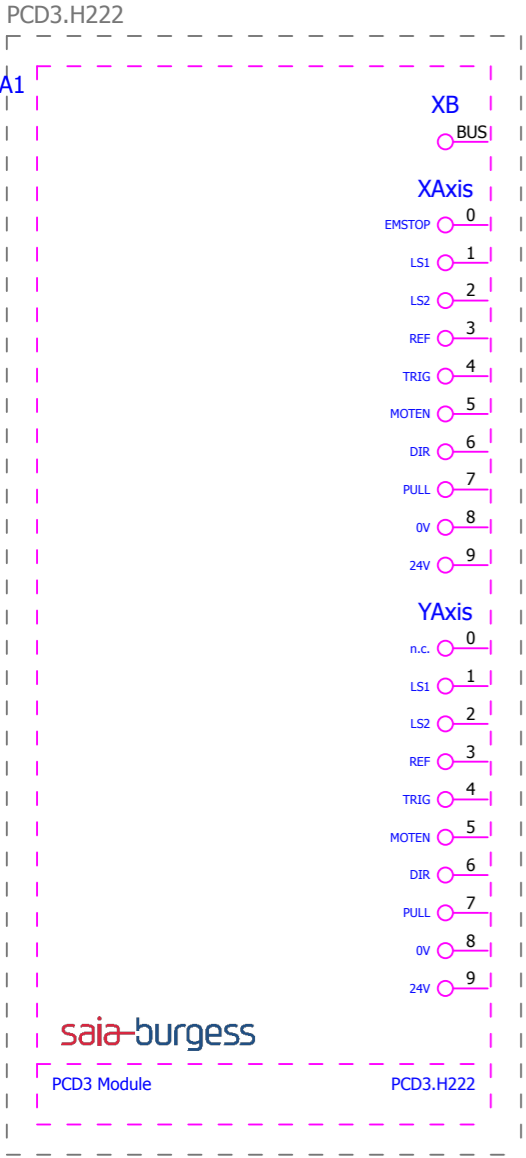

Saia-Burgess\PCD3 Module\PCD3.H222.ema
 Overview
 Variant A
 2012-10-26 / 2.1.4

			Datum	26.10.2012	EPLAN Software & Service Saia-Burgess Makroprojekt	Saia-Burgess Controls Ltd. Control Systems and Components	Saia-Burgess Controls Ltd.	SPS-Übersicht	= PCD3 Module		Blatt 10
		Bearb.	KAF	+ PCD3.H222							
		Gepr									
Änderung	Datum	Name	Ürspr		Ersatz von	Ersetzt durch				Blatt 522	

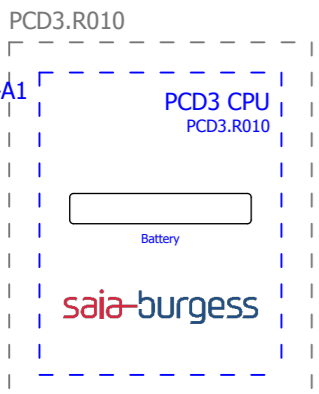

Saia-Burgess\PCD3 Module\PCD3.R010.ema
Multi-line
Variant A
2012-10-26 / 2.1.4

			Datum	26.10.2012	 EPLAN Software & Service  Saia-Burgess Makroprojekt	 Saia-Burgess Controls Ltd. <small>Control Systems and Components</small>	Saia-Burgess Controls Ltd.	Allpolig	= PCD3 Module	
		Bearb.	KAF	+ PCD3.R010						
		Gepr							Blatt 1	
Änderung	Datum	Name	Urspr		Ersatz von	Ersetzt durch			Blatt 522	

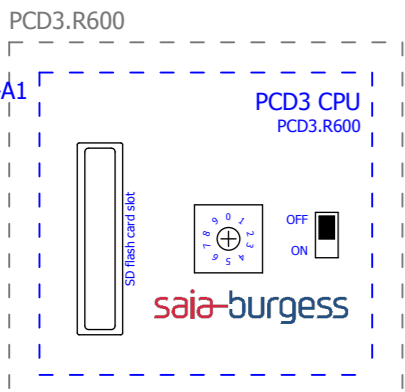

Saia-Burgess\PCD3 Module\PCD3.R600.ema
 Multi-line
 Variant A
 2012-10-26 / 2.1.4

			Datum	26.10.2012	 EPLAN Software & Service  Saia-Burgess Makroprojekt	 Saia-Burgess Controls Ltd. <small>Control Systems and Components</small>	Saia-Burgess Controls Ltd.	Allpolig	= PCD3 Module		Blatt 1
		Bearb.	KAF	+ PCD3.R600							
		Gepr									
Änderung	Datum	Name	Urspr		Ersatz von	Ersetzt durch				Blatt 522	

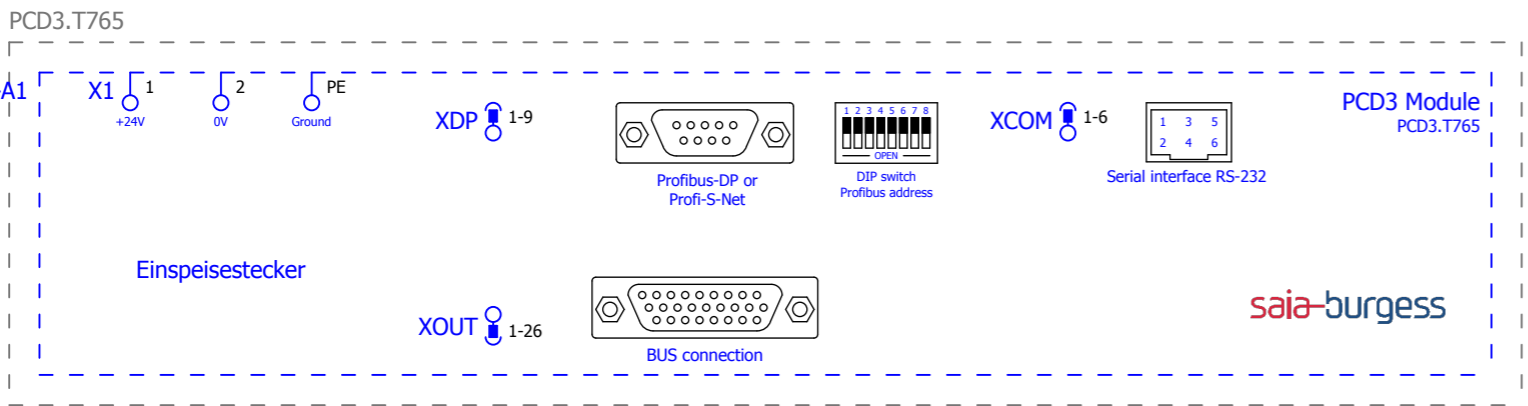

Saia-Burgess\PCD3 Module\PCD3.T765.ema
 Multi-line
 Variant A
 2012-10-26 / 2.1.4

			Datum	26.10.2012	EPLAN Software & Service Saia-Burgess Makroprojekt	 Control Systems and Components	Saia-Burgess Controls Ltd.	Allpolig		= PCD3 Module		
			Bearb.	KAF							+ PCD3.T765	
			Gepr									Blatt
Änderung	Datum	Name	Urspr		Ersatz von	Ersetzt durch				Blatt	522	

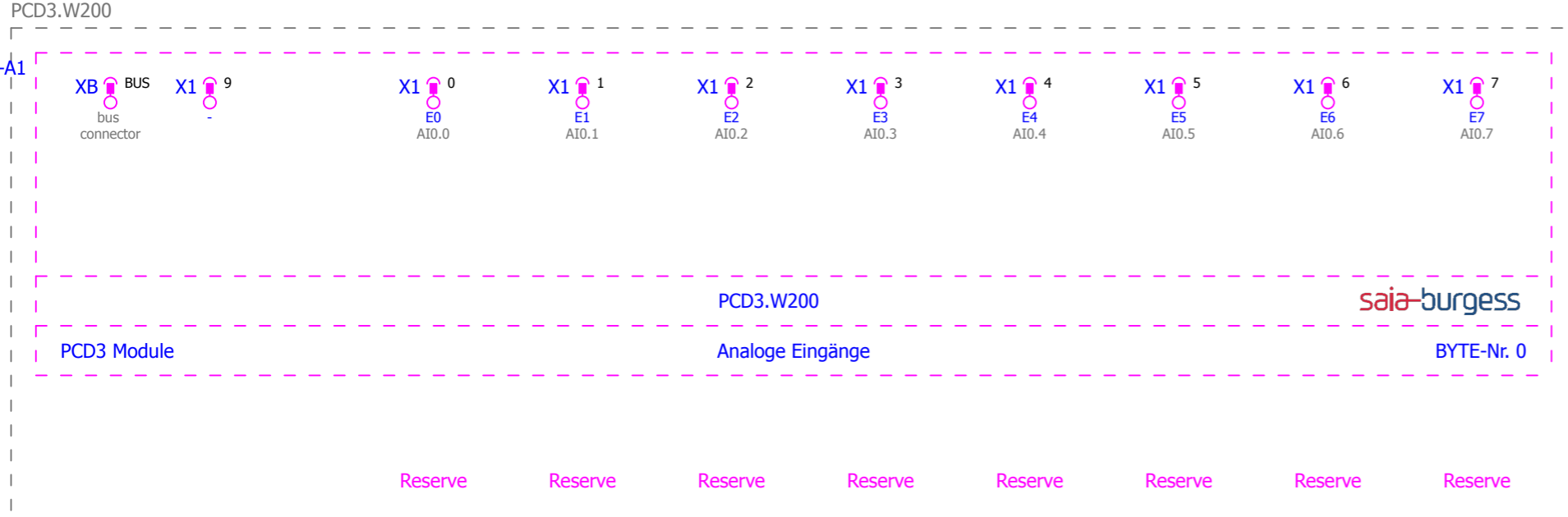

Saia-Burgess\PCD3 Module\PCD3.W200.ema
 Multi-line
 Variant A
 2012-10-26 / 2.1.4

+..T765/1

			Datum	26.10.2012	EPLAN Software & Service Saia-Burgess Makroprojekt	Saia-Burgess Controls Ltd. Control Systems and Components	Saia-Burgess Controls Ltd.	Allpolig	= PCD3 Module		Blatt 1
		Bearb.	KAF	+ PCD3.W200							
		Gepr									
Änderung	Datum	Name	Urspr	Ersatz von	Ersetzt durch					Blatt	522

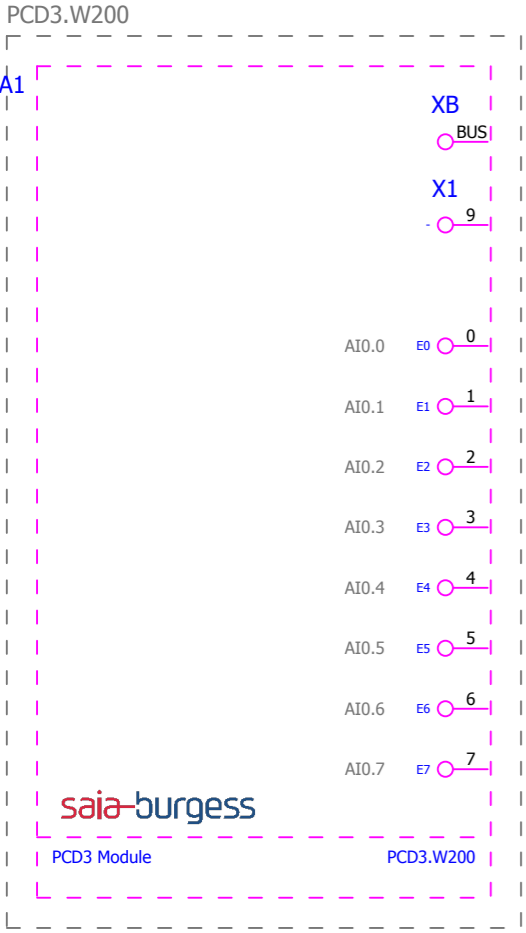

bus connector

Reserve

Reserve

Reserve

Reserve

Reserve

Reserve

Reserve

Reserve

Reserve

Saia-Burgess\PCD3 Module\PCD3.W200.ema
 Overview
 Variant A
 2012-10-26 / 2.1.4

			Datum	26.10.2012	EPLAN Software & Service Saia-Burgess Makroprojekt	Saia-Burgess Controls Ltd. Control Systems and Components	Saia-Burgess Controls Ltd.	SPS-Übersicht	= PCD3 Module		Blatt 10
			Bearb.	KAF					+ PCD3.W200		
			Gepr								
Änderung	Datum	Name	Urspr		Ersatz von	Ersetzt durch					

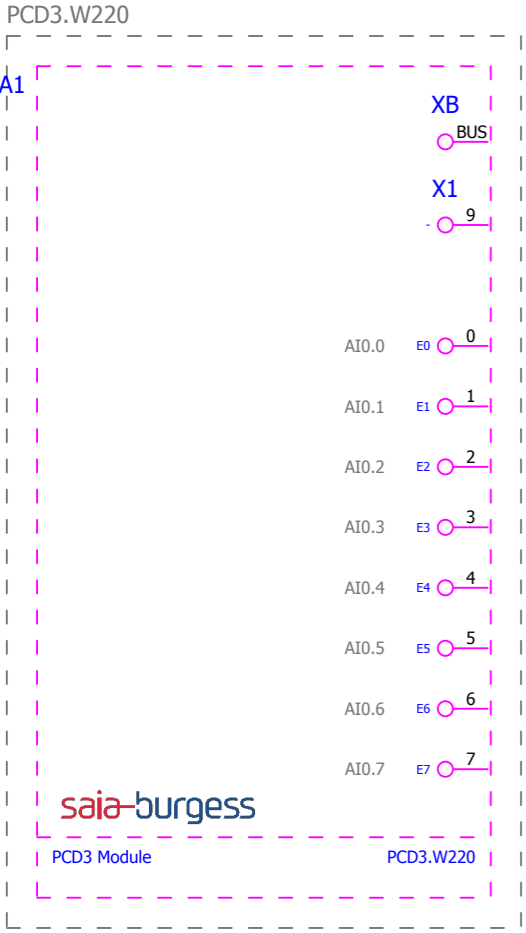

bus connector

Reserve

Reserve

Reserve

Reserve

Reserve

Reserve

Reserve

Reserve

Reserve

Saia-Burgess\PCD3 Module\PCD3.W220.ema
 Overview
 Variant A
 2012-10-26 / 2.1.4

			Datum	26.10.2012	EPLAN Software & Service Saia-Burgess Makroprojekt	Saia-Burgess Controls Ltd. Control Systems and Components	Saia-Burgess Controls Ltd.	SPS-Übersicht	= PCD3 Module		Blatt 10
		Bearb.	KAF	+ PCD3.W220							
		Gepr									
Änderung	Datum	Name	Urspr		Ersatz von	Ersetzt durch				Blatt	522

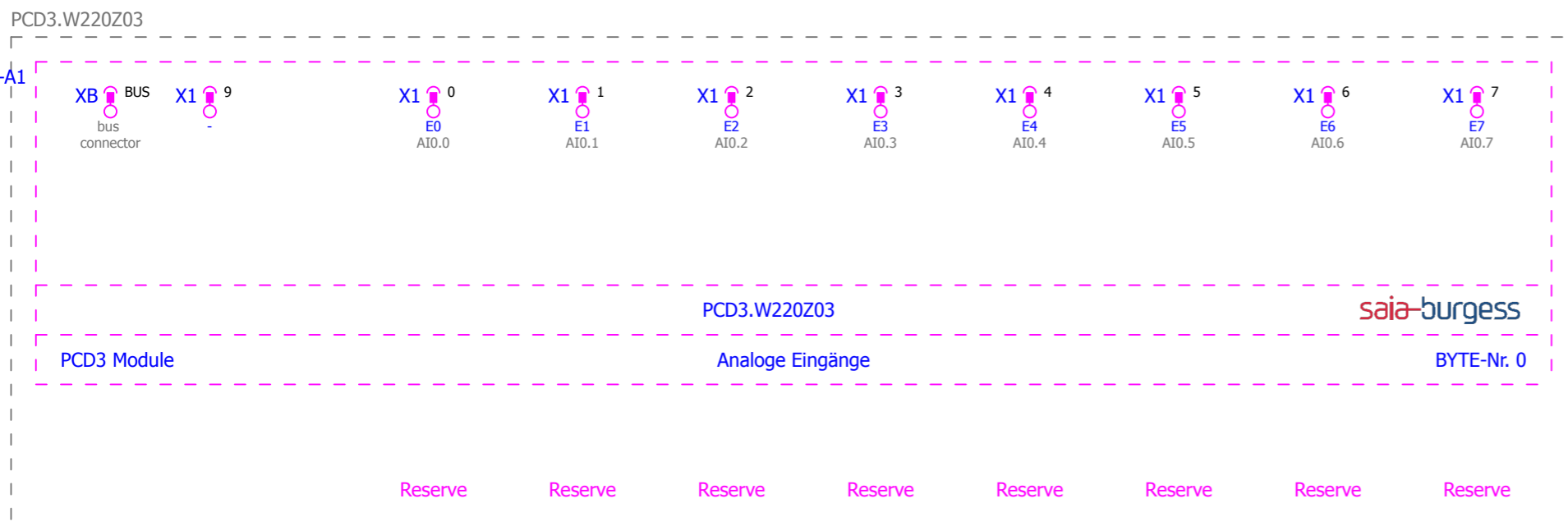

Saia-Burgess\PCD3 Module\PCD3.W220Z03.ema
 Multi-line
 Variant A
 2012-10-26 / 2.1.4

+ .W220/10

10

			Datum	26.10.2012	EPLAN Software & Service Saia-Burgess Makroprojekt	 Control Systems and Components	Saia-Burgess Controls Ltd.	Allpolig	= PCD3 Module		Blatt 1
		Bearb.	KAF	+ PCD3.W220Z03							
		Gepr									
Änderung	Datum	Name	Urspr	Ersatz von	Ersetzt durch					Blatt	522

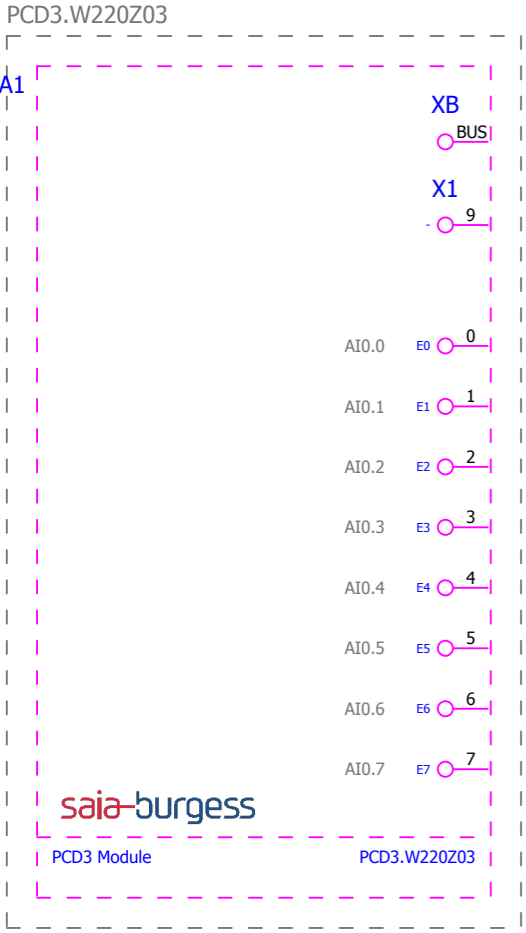

bus connector

Reserve

Reserve

Reserve

Reserve

Reserve

Reserve

Reserve

Reserve

Reserve

Saia-Burgess\PCD3 Module\PCD3.W220Z03.ema
Overview
Variant A
2012-10-26 / 2.1.4

			Datum	26.10.2012	EPLAN Software & Service Saia-Burgess Makroprojekt	Saia-Burgess Controls Ltd. Control Systems and Components	Saia-Burgess Controls Ltd.	SPS-Übersicht	= PCD3 Module		Blatt 10
			Bearb.	KAF					+ PCD3.W220Z03		
			Gepr								
Änderung	Datum	Name	Urspr		Ersatz von	Ersetzt durch				Blatt	522

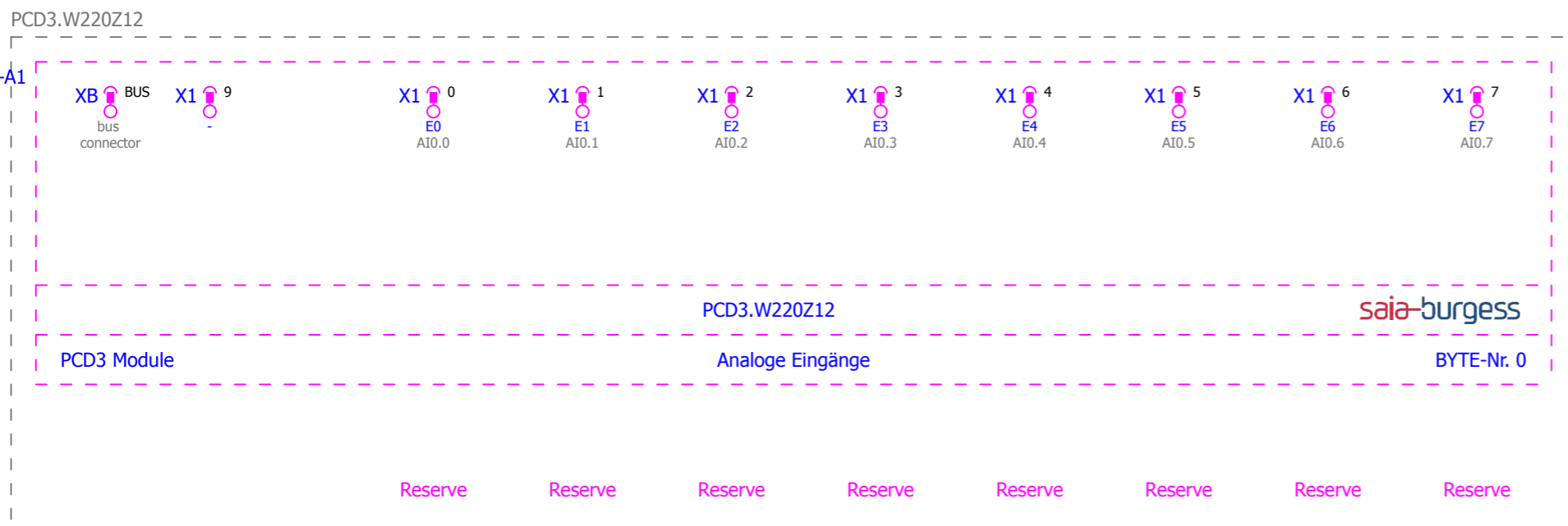

Saia-Burgess\PCD3 Module\PCD3.W220Z12.ema
 Multi-line
 Variant A
 2012-10-26 / 2.1.4
 +.W220Z03/10

			Datum	26.10.2012	EPLAN Software & Service Saia-Burgess Makroprojekt	Saia-Burgess Controls Ltd. Control Systems and Components	Saia-Burgess Controls Ltd.	Allpolig			= PCD3 Module	
			Bearb.	KAF							+ PCD3.W220Z12	
			Gepr									
Änderung	Datum	Name	Urspr		Ersatz von	Ersetzt durch			Blatt	1		
									Blatt	522		

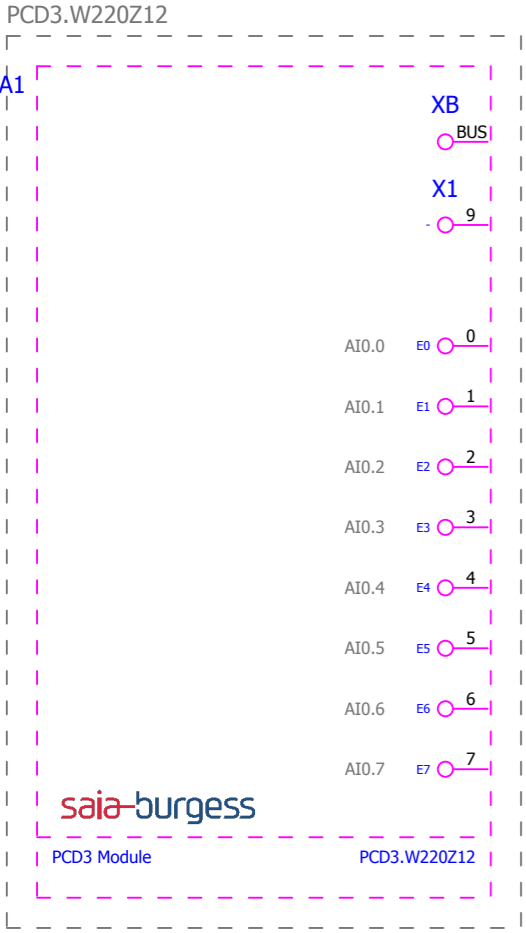

bus connector

Reserve

Reserve

Reserve

Reserve

Reserve

Reserve

Reserve

Reserve

Reserve

Saia-Burgess\PCD3 Module\PCD3.W220Z12.ema
Overview
Variant A
2012-10-26 / 2.1.4

			Datum	26.10.2012	EPLAN Software & Service Saia-Burgess Makroprojekt	Saia-Burgess Controls Ltd. Control Systems and Components	Saia-Burgess Controls Ltd.	SPS-Übersicht	= PCD3 Module		Blatt 10
			Bearb.	KAF					+ PCD3.W220Z12		
			Gepr								
Änderung	Datum	Name	Urspr		Ersatz von	Ersetzt durch				Blatt	522

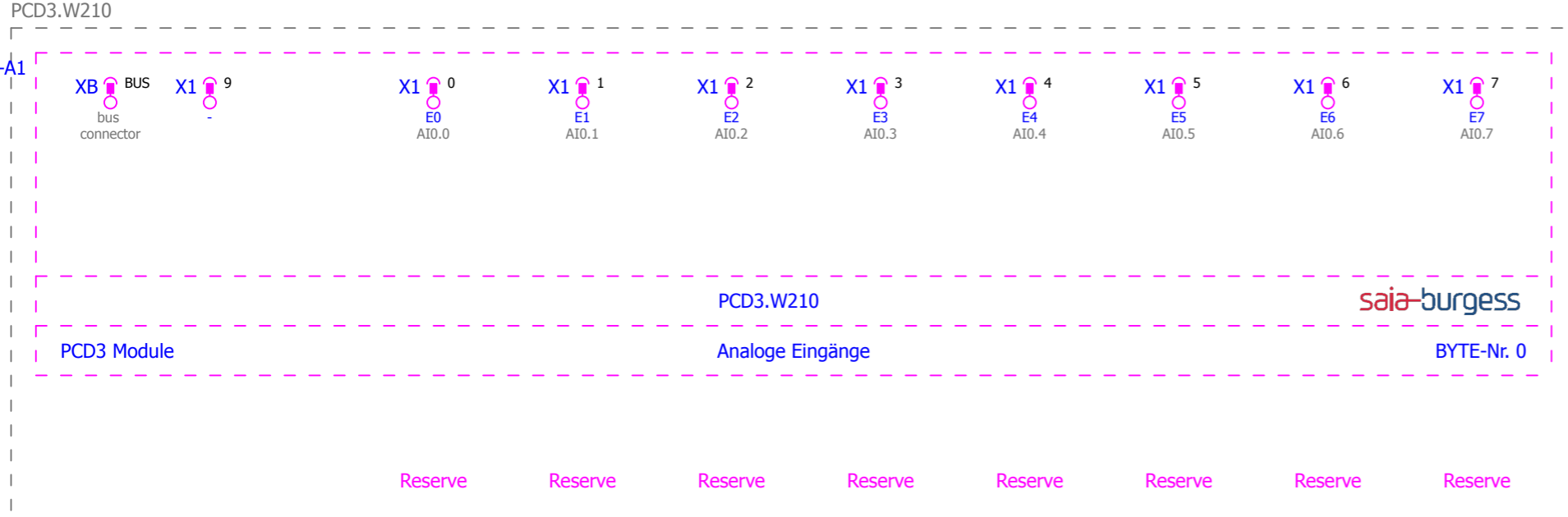

Saia-Burgess\PCD3 Module\PCD3.W210.ema
 Multi-line
 Variant A
 2012-10-26 / 2.1.4
 +.W220Z12/10

			Datum	26.10.2012	EPLAN Software & Service Saia-Burgess Makroprojekt	Saia-Burgess Controls Ltd. Control Systems and Components	Saia-Burgess Controls Ltd.	Allpolig			= PCD3 Module		
			Bearb.	KAF									+ PCD3.W210
			Gepr										Blatt 1
Änderung	Datum	Name	Urspr		Ersatz von	Ersetzt durch					Blatt 522		

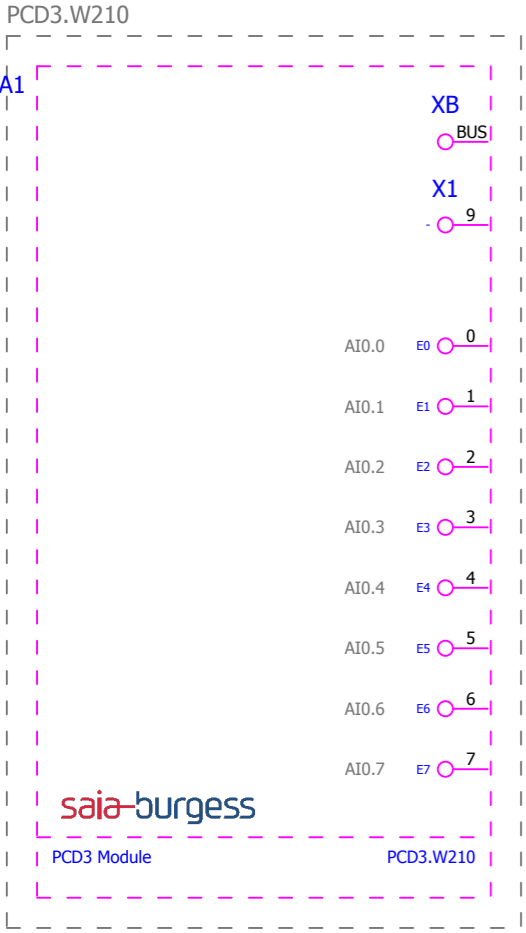

bus connector

Reserve

Reserve

Reserve

Reserve

Reserve

Reserve

Reserve

Reserve

Reserve

Saia-Burgess\PCD3 Module\PCD3.W210.ema
 Overview
 Variant A
 2012-10-26 / 2.1.4

			Datum	26.10.2012	EPLAN Software & Service Saia-Burgess Makroprojekt <small>Control Systems and Components</small>	Saia-Burgess Controls Ltd.	SPS-Übersicht	= PCD3 Module		
		Bearb.	KAF	+ PCD3.W210						
		Gepr							Blatt	10
Änderung	Datum	Name	Urspr		Ersatz von	Ersetzt durch			Blatt	522

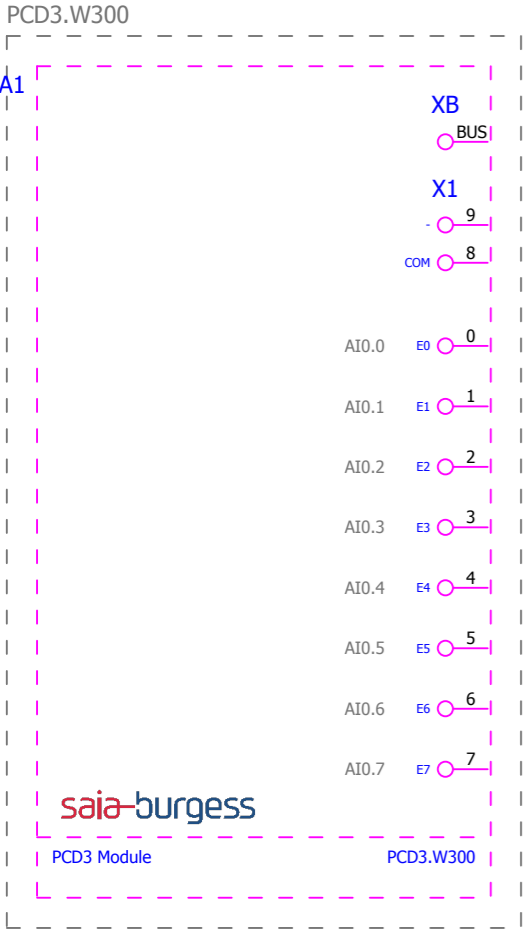

bus connector

Reserve

Reserve

Reserve

Reserve

Reserve

Reserve

Reserve

Reserve

Saia-Burgess\PCD3 Module\PCD3.W300.ema
 Overview
 Variant A
 2012-10-26 / 2.1.4

			Datum	26.10.2012	EPLAN Software & Service Saia-Burgess Makroprojekt	Saia-Burgess Controls Ltd. Control Systems and Components	Saia-Burgess Controls Ltd.	SPS-Übersicht	= PCD3 Module		Blatt 10
			Bearb.	KAF					+ PCD3.W300		
			Gepr								
Änderung	Datum	Name	Urspr		Ersatz von	Ersetzt durch					

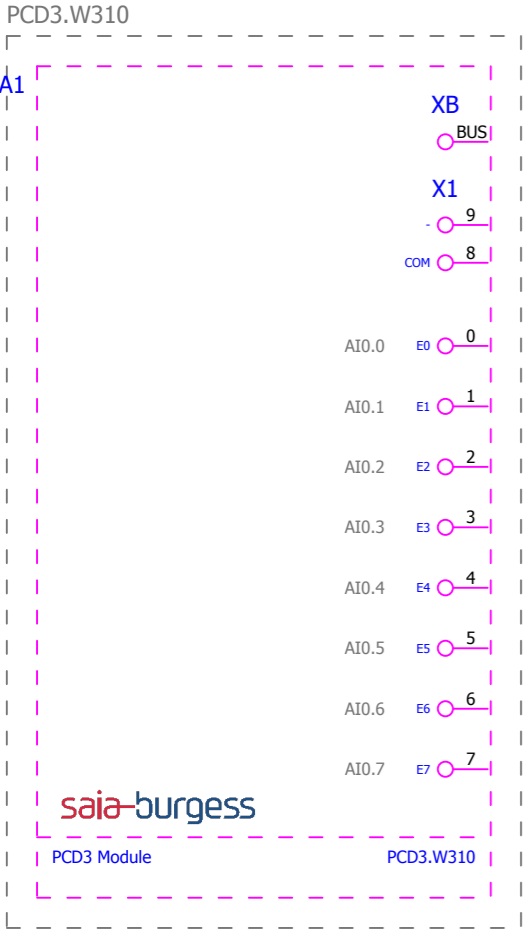

bus connector

Reserve

Reserve

Reserve

Reserve

Reserve

Reserve

Reserve

Reserve

Reserve

Saia-Burgess\PCD3 Module\PCD3.W310.ema
Overview
Variant A
2012-10-26 / 2.1.4

			Datum	26.10.2012	EPLAN Software & Service Saia-Burgess Makroprojekt	Saia-Burgess Controls Ltd.	SPS-Übersicht	= PCD3 Module		
		Bearb.	KAF	+ PCD3.W310						
		Gepr						Blatt	10	
Änderung	Datum	Name	Üspr		Ersatz von	Ersetzt durch			Blatt	522

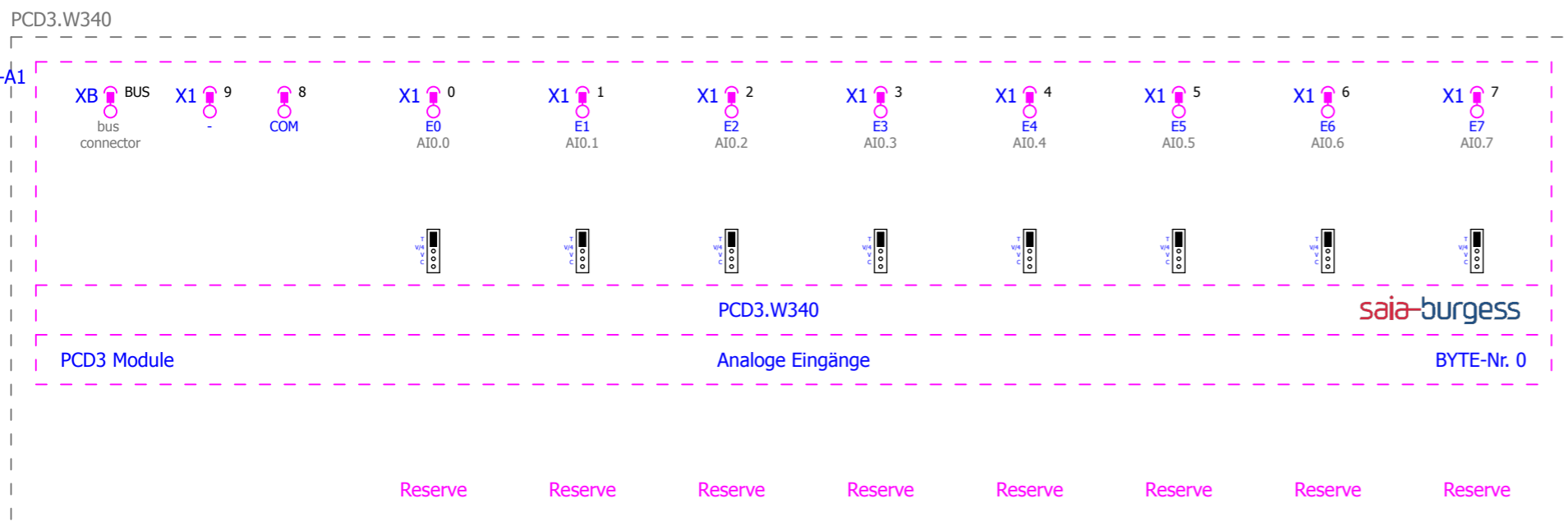

Saia-Burgess\PCD3 Module\PCD3.W340.ema
 Multi-line
 Variant A
 2012-10-26 / 2.1.4

+ .W310/10

			Datum	26.10.2012	EPLAN Software & Service Saia-Burgess Makroprojekt	Saia-Burgess Controls Ltd. Control Systems and Components	Saia-Burgess Controls Ltd.	Allpolig	= PCD3 Module		Blatt 1	
			Bearb.	KAF					+ PCD3.W340			Blatt 522
			Gepr									
Änderung	Datum	Name	Urspr	Ersatz von	Ersetzt durch							



bus connector

Reserve

Reserve

Reserve

Reserve

Reserve

Reserve

Reserve

Reserve

Reserve

Saia-Burgess\PCD3 Module\PCD3.W340.ema
 Overview
 Variant A
 2012-10-26 / 2.1.4

			Datum	26.10.2012	EPLAN Software & Service Saia-Burgess Makroprojekt	Saia-Burgess Controls Ltd. Control Systems and Components	Saia-Burgess Controls Ltd.	SPS-Übersicht	= PCD3 Module		Blatt 10
		Bearb.	KAF	+ PCD3.W340							
		Gepr									
Änderung	Datum	Name	Urspr		Ersatz von	Ersetzt durch				Blatt	522

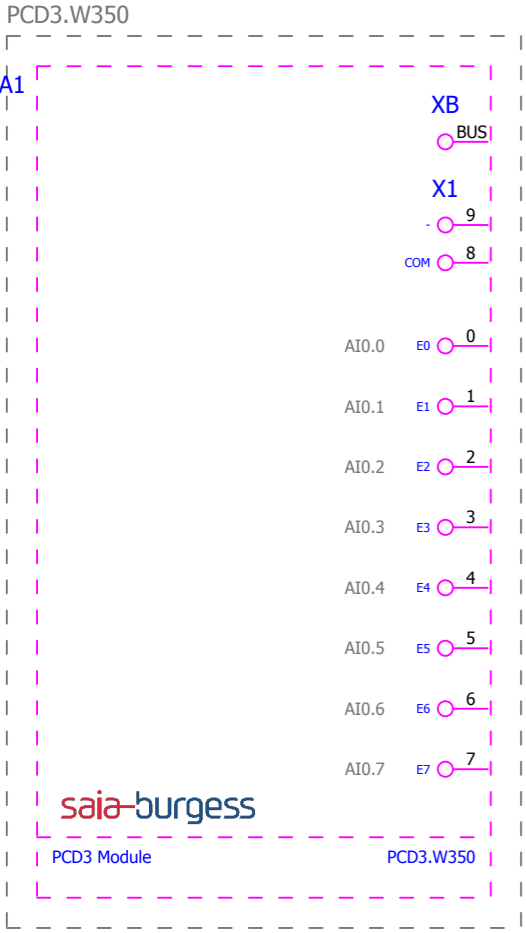

bus connector

Reserve

Reserve

Reserve

Reserve

Reserve

Reserve

Reserve

Reserve

Saia-Burgess\PCD3 Module\PCD3.W350.ema
 Overview
 Variant A
 2012-10-26 / 2.1.4

			Datum	26.10.2012	EPLAN Software & Service Saia-Burgess Makroprojekt	Saia-Burgess Controls Ltd. Control Systems and Components	Saia-Burgess Controls Ltd.	SPS-Übersicht	= PCD3 Module		Blatt 10
			Bearb.	KAF					+ PCD3.W350		
			Gepr								
Änderung	Datum	Name	Urspr		Ersatz von	Ersetzt durch				Blatt	522

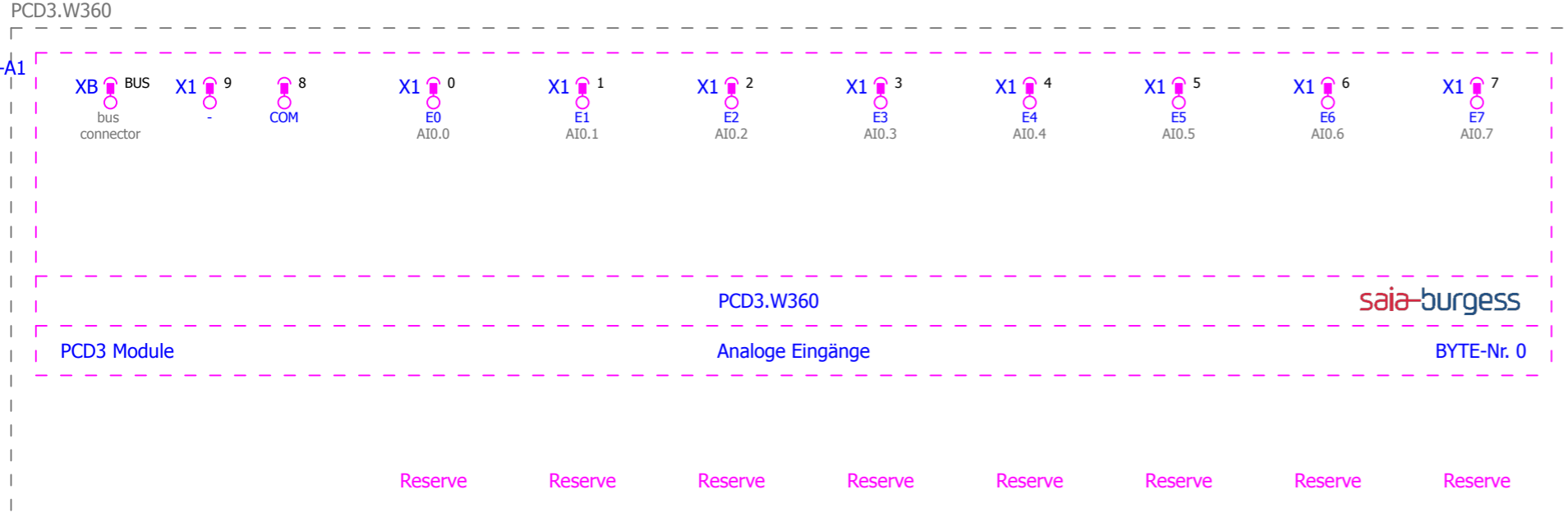

Saia-Burgess\PCD3 Module\PCD3.W360.ema
 Multi-line
 Variant A
 2012-10-26 / 2.1.4

			Datum	26.10.2012	EPLAN Software & Service Saia-Burgess Makroprojekt	Saia-Burgess Controls Ltd. Control Systems and Components	Saia-Burgess Controls Ltd.	Allpolig	= PCD3 Module		Blatt 1	
			Bearb.	KAF					+ PCD3.W360			Blatt 522
			Gepr									
Änderung	Datum	Name	Urspr		Ersatz von	Ersetzt durch						

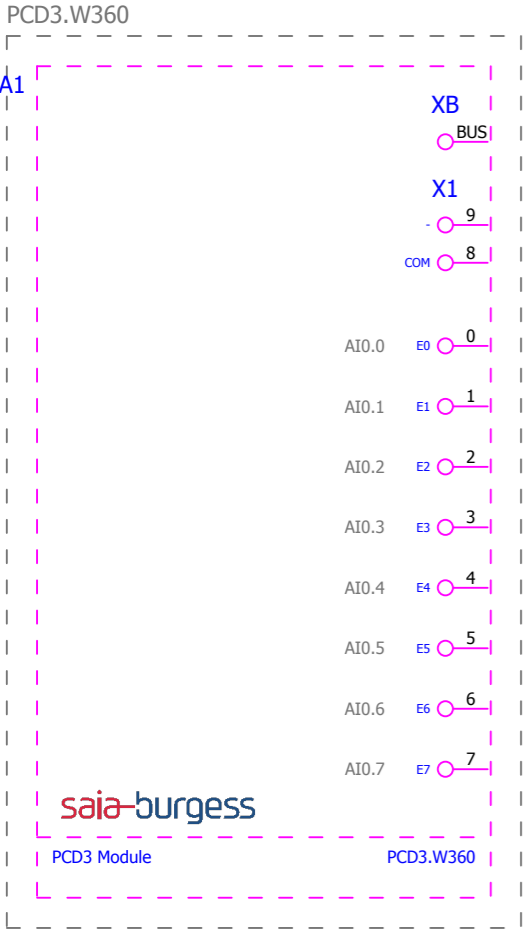

bus connector

Reserve

Reserve

Reserve

Reserve

Reserve

Reserve

Reserve

Reserve

Saia-Burgess\PCD3 Module\PCD3.W360.ema
 Overview
 Variant A
 2012-10-26 / 2.1.4

			Datum	26.10.2012	EPLAN Software & Service Saia-Burgess Makroprojekt	Saia-Burgess Controls Ltd. Control Systems and Components	Saia-Burgess Controls Ltd.	SPS-Übersicht	= PCD3 Module		Blatt 10
			Bearb.	KAF					+ PCD3.W360		
			Gepr								
Änderung	Datum	Name	Urspr		Ersatz von	Ersetzt durch				Blatt	522

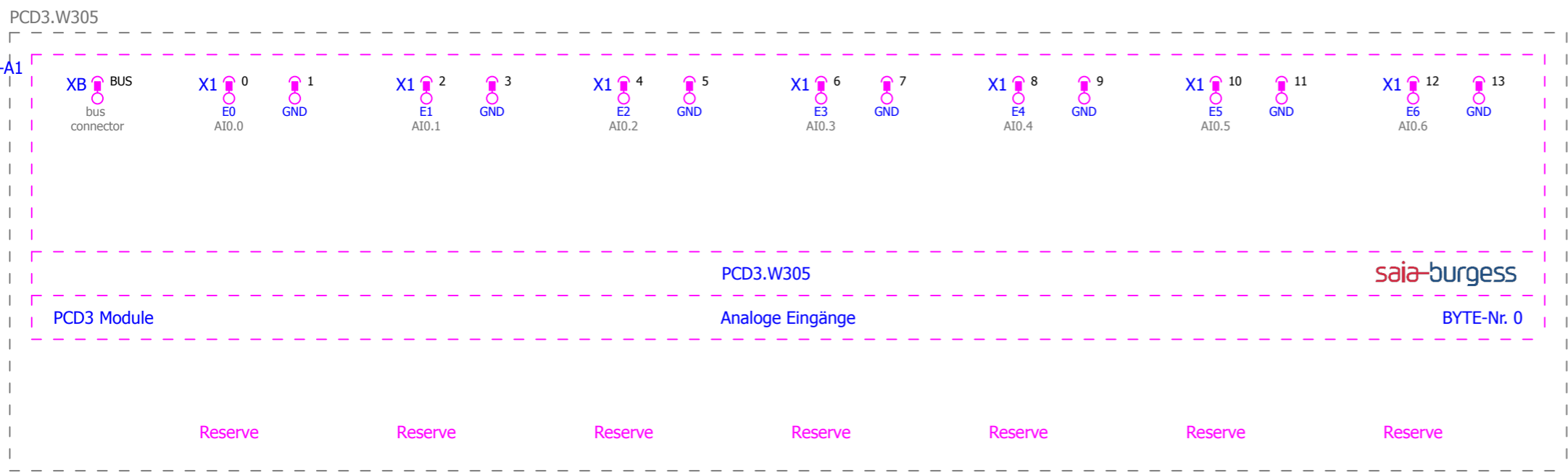

Saia-Burgess\PCD3 Module\PCD3.W305.ema
 Multi-line
 Variant A
 2012-10-26 / 2.1.4

+ .W360/10

			Datum	26.10.2012	EPLAN Software & Service Saia-Burgess Makroprojekt	Saia-Burgess Controls Ltd. Control Systems and Components	Saia-Burgess Controls Ltd.	Allpolig	= PCD3 Module		Blatt 1	
			Bearb.	KAF					+ PCD3.W305			Blatt 522
			Gepr									
Änderung	Datum	Name	Urspr		Ersatz von	Ersetzt durch						



bus connector
Reserve
Reserve
Reserve
Reserve
Reserve
Reserve
Reserve



Saia-Burgess\PCD3 Module\PCD3.W305.ema
Overview
Variant A
2012-10-26 / 2.1.4

			Datum	26.10.2012	EPLAN Software & Service Saia-Burgess Makroprojekt	Saia-Burgess Controls Ltd. Control Systems and Components	Saia-Burgess Controls Ltd.	SPS-Übersicht	= PCD3 Module		Blatt 10
		Bearb.	KAF	+ PCD3.W305							
		Gepr									
Änderung	Datum	Name	Ürspr		Ersatz von	Ersetzt durch				Blatt	522



bus connector
Reserve
Reserve
Reserve
Reserve
Reserve
Reserve
Reserve



Saia-Burgess\PCD3 Module\PCD3.W315.ema
Overview
Variant A
2012-10-26 / 2.1.4

			Datum	26.10.2012	EPLAN Software & Service Saia-Burgess Makroprojekt	Saia-Burgess Controls Ltd. Control Systems and Components	Saia-Burgess Controls Ltd.	SPS-Übersicht	= PCD3 Module		Blatt 10
		Bearb.	KAF	+ PCD3.W315							
		Gepr									
Änderung	Datum	Name	Urspr		Ersatz von	Ersetzt durch				Blatt	522

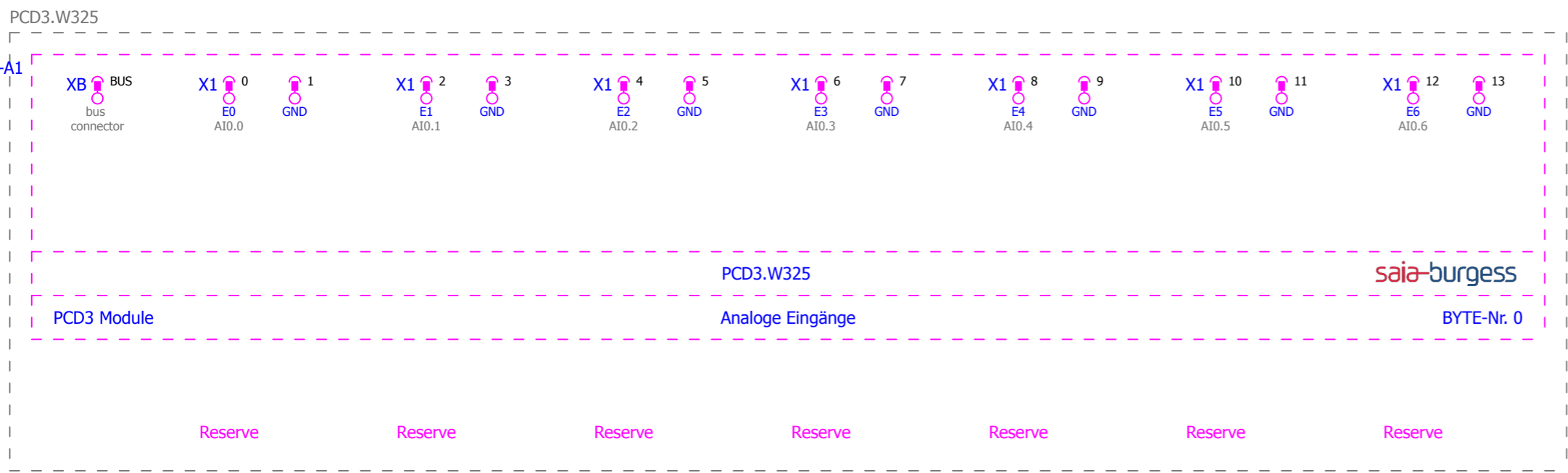

Saia-Burgess\PCD3 Module\PCD3.W325.ema
 Multi-line
 Variant A
 2012-10-26 / 2.1.4

+ .W315/10

			Datum	26.10.2012	EPLAN Software & Service Saia-Burgess Makroprojekt	Saia-Burgess Controls Ltd. Control Systems and Components	Saia-Burgess Controls Ltd.	Allpolig	= PCD3 Module		Blatt 1	
			Bearb.	KAF					+ PCD3.W325			Blatt 522
			Gepr									
Änderung	Datum	Name	Urspr		Ersatz von	Ersetzt durch						



bus connector
Reserve
Reserve
Reserve
Reserve
Reserve
Reserve
Reserve



Saia-Burgess\PCD3 Module\PCD3.W325.ema
Overview
Variant A
2012-10-26 / 2.1.4

			Datum	26.10.2012	EPLAN Software & Service Saia-Burgess Makroprojekt	Saia-Burgess Controls Ltd. Control Systems and Components	Saia-Burgess Controls Ltd.	SPS-Übersicht	= PCD3 Module		Blatt 10
			Bearb.	KAF					+ PCD3.W325		
			Gepr								
Änderung	Datum	Name	Ürspr		Ersatz von	Ersetzt durch				Blatt	522

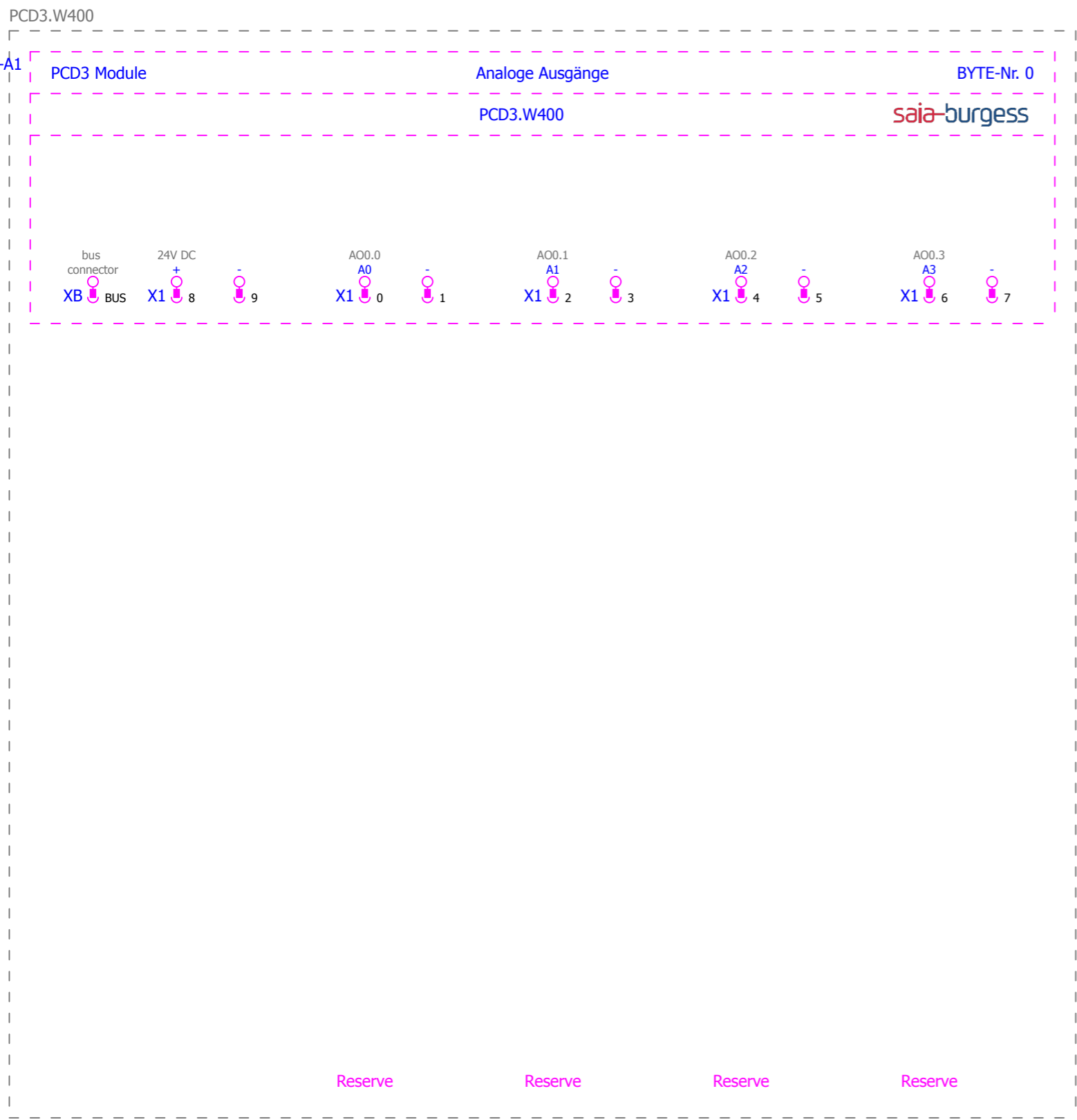

Saia-Burgess\PCD3 Module\PCD3.W400.ema
 Multi-line
 Variant A
 2012-10-26 / 2.1.4

+ .W325/10

			Datum	26.10.2012	EPLAN Software & Service Saia-Burgess Makroprojekt	 Control Systems and Components	Saia-Burgess Controls Ltd.	Allpolig		= PCD3 Module		
			Bearb.	KAF						+ PCD3.W400		
			Gepr									Blatt 1
Änderung	Datum	Name	Urspr		Ersatz von	Ersetzt durch					Blatt 522	



bus connector
 24V DC
 Reserve
 Reserve
 Reserve
 Reserve

Saia-Burgess\PCD3 Module\PCD3.W400.ema
 Overview
 Variant A
 2012-10-26 / 2.1.4

			Datum	26.10.2012	EPLAN Software & Service Saia-Burgess Makroprojekt	Saia-Burgess Controls Ltd. Control Systems and Components	Saia-Burgess Controls Ltd.	SPS-Übersicht	= PCD3 Module		Blatt 10
		Bearb.	KAF	+ PCD3.W400							
		Gepr									
Änderung	Datum	Name	Urspr	Ersatz von	Ersetzt durch					Blatt 522	

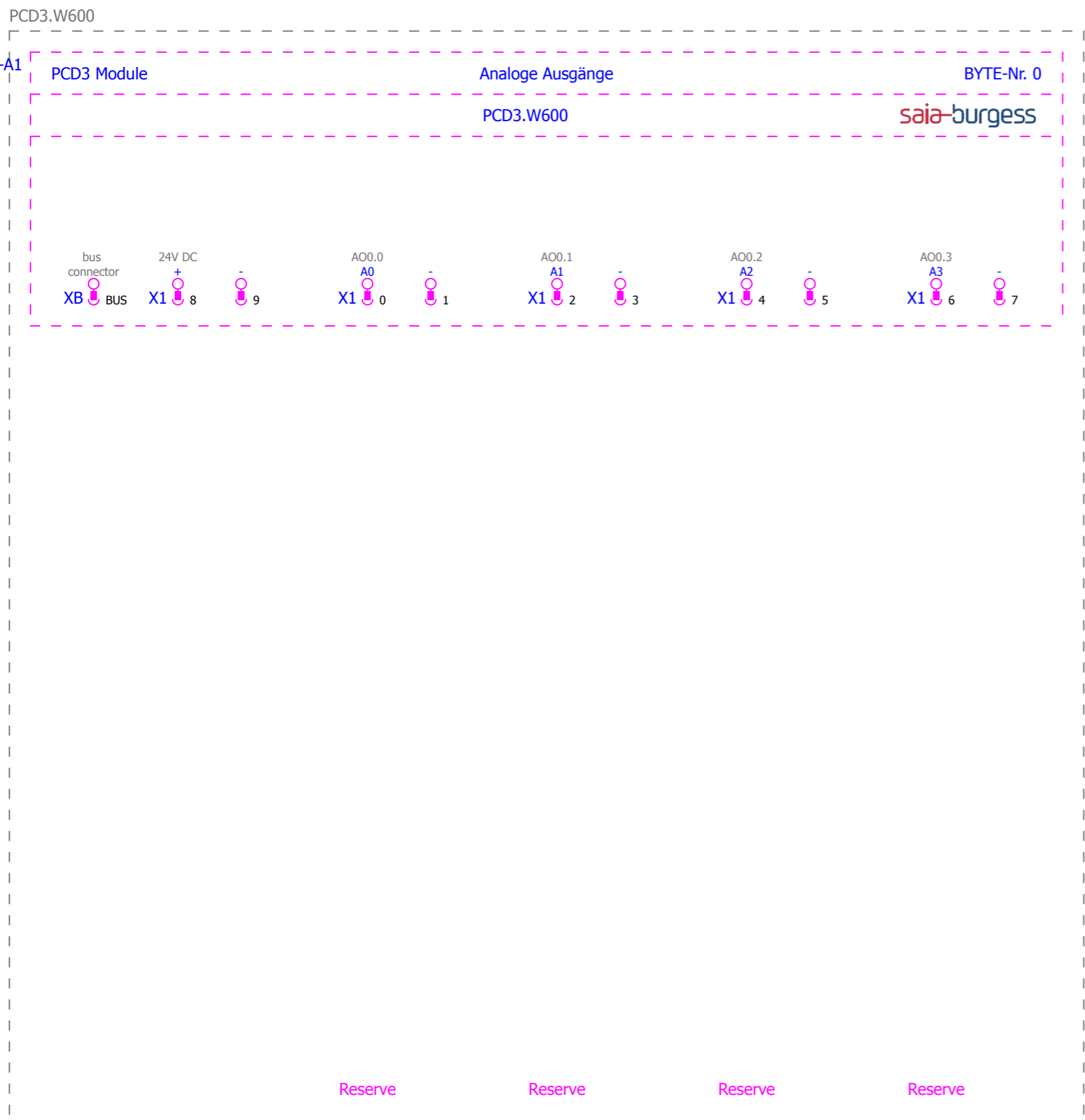

Saia-Burgess\PCD3 Module\PCD3.W600.ema
 Multi-line
 Variant A
 2012-10-26 / 2.1.4

+ .W410/10

10

			Datum	26.10.2012	EPLAN Software & Service Saia-Burgess Makroprojekt	 Control Systems and Components	Saia-Burgess Controls Ltd.	Allpolig		= PCD3 Module		
			Bearb.	KAF						+ PCD3.W600		
			Gepr									Blatt 1
Änderung	Datum	Name	Urspr		Ersatz von	Ersetzt durch					Blatt 522	



bus connector
 24V DC
 Reserve
 Reserve
 Reserve
 Reserve

Saia-Burgess\PCD3 Module\PCD3.W600.ema
 Overview
 Variant A
 2012-10-26 / 2.1.4

			Datum	26.10.2012	EPLAN Software & Service Saia-Burgess Makroprojekt	Saia-Burgess Controls Ltd. Control Systems and Components	Saia-Burgess Controls Ltd.	SPS-Übersicht	= PCD3 Module		Blatt 10
		Bearb.	KAF	+ PCD3.W600							
		Gepr									
Änderung	Datum	Name	Urspr		Ersatz von	Ersetzt durch				Blatt	522

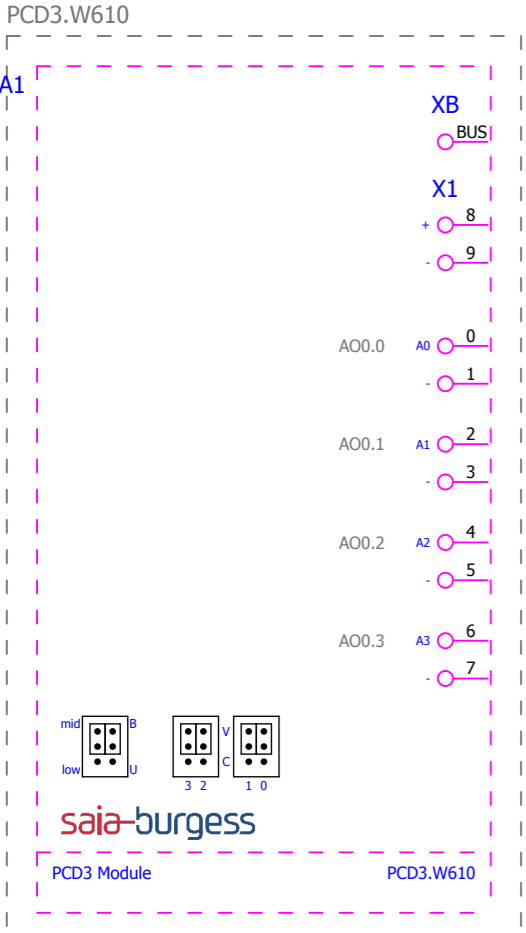

- bus connector
- 24V DC
- Reserve
- Reserve
- Reserve
- Reserve

Saia-Burgess\PCD3 Module\PCD3.W610.ema
 Overview
 Variant A
 2012-10-26 / 2.1.4

			Datum	26.10.2012	EPLAN Software & Service Saia-Burgess Makroprojekt	Saia-Burgess Controls Ltd. Control Systems and Components	Saia-Burgess Controls Ltd.	SPS-Übersicht	= PCD3 Module		Blatt 10
		Bearb.	KAF	+ PCD3.W610							
		Gepr									
Änderung	Datum	Name	Urspr		Ersatz von	Ersetzt durch				Blatt	522

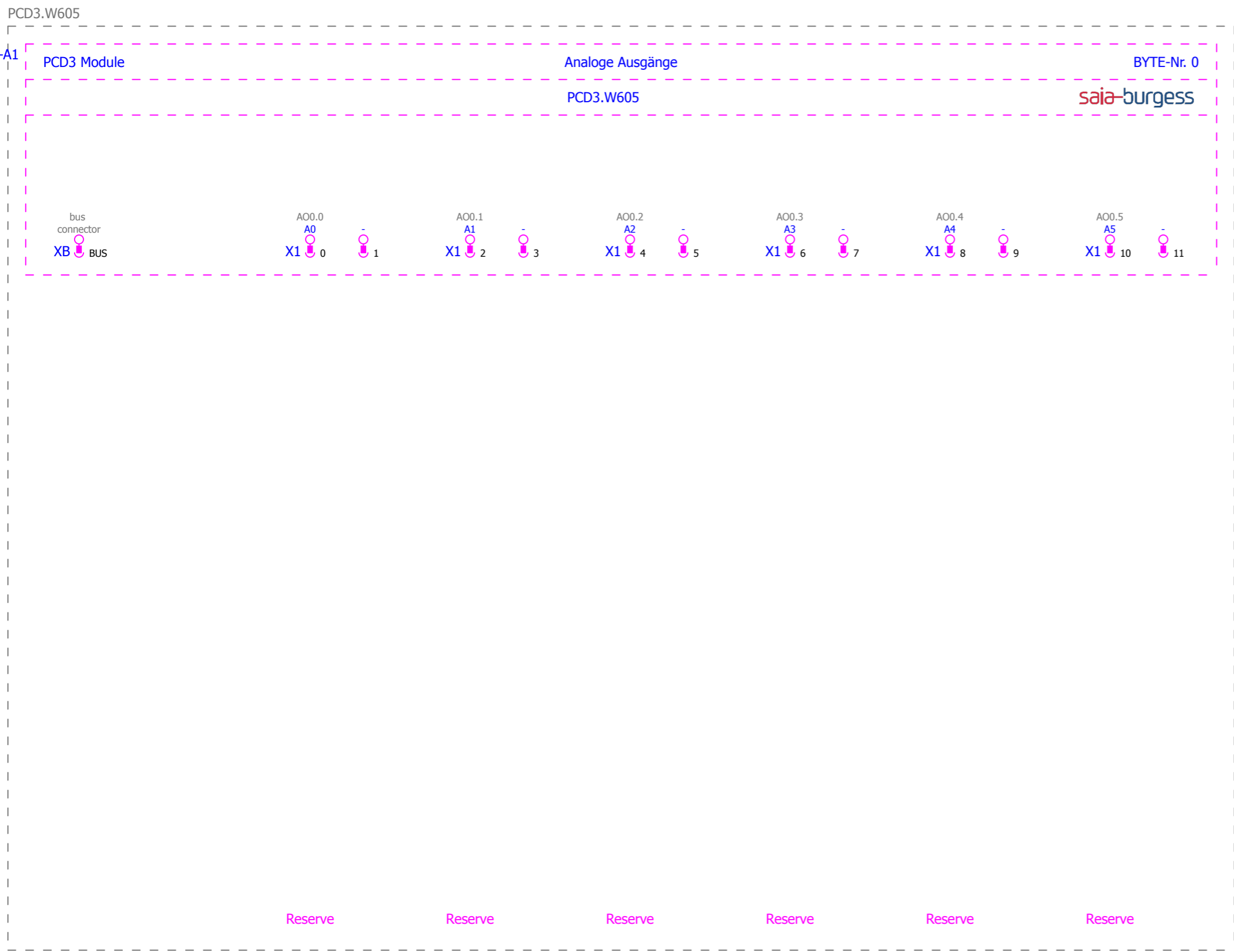

Saia-Burgess\PCD3 Module\PCD3.W605.ema
 Multi-line
 Variant A
 2012-10-26 / 2.1.4

+ .W610/10

			Datum	26.10.2012	EPLAN Software & Service Saia-Burgess Makroprojekt	Saia-Burgess Controls Ltd. <small>Control Systems and Components</small>	Allpolig	= PCD3 Module	
		Bearb.	KAF	+ PCD3.W605					
		Gepr		Blatt				1	
Änderung	Datum	Name	Urspr	Ersatz von	Ersetzt durch			Blatt	522

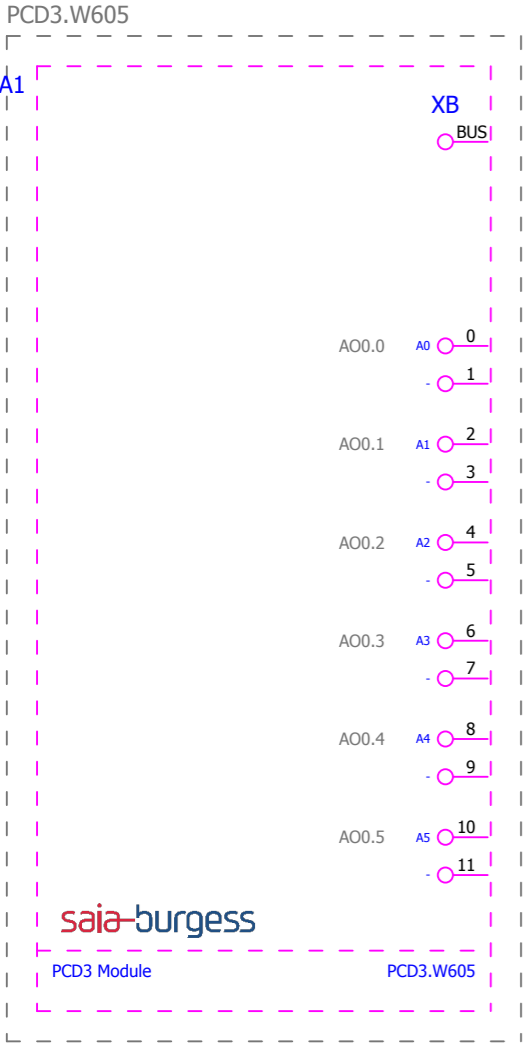

bus connector

Reserve

Reserve

Reserve

Reserve

Reserve

Reserve

Saia-Burgess\PCD3 Module\PCD3.W605.ema
 Overview
 Variant A
 2012-10-26 / 2.1.4

			Datum	26.10.2012	EPLAN Software & Service Saia-Burgess Makroprojekt	Saia-Burgess Controls Ltd. Control Systems and Components	Saia-Burgess Controls Ltd.	SPS-Übersicht	= PCD3 Module		Blatt 10
			Bearb.	KAF					+ PCD3.W605		
			Gepr								
Änderung	Datum	Name	Urspr		Ersatz von	Ersetzt durch					

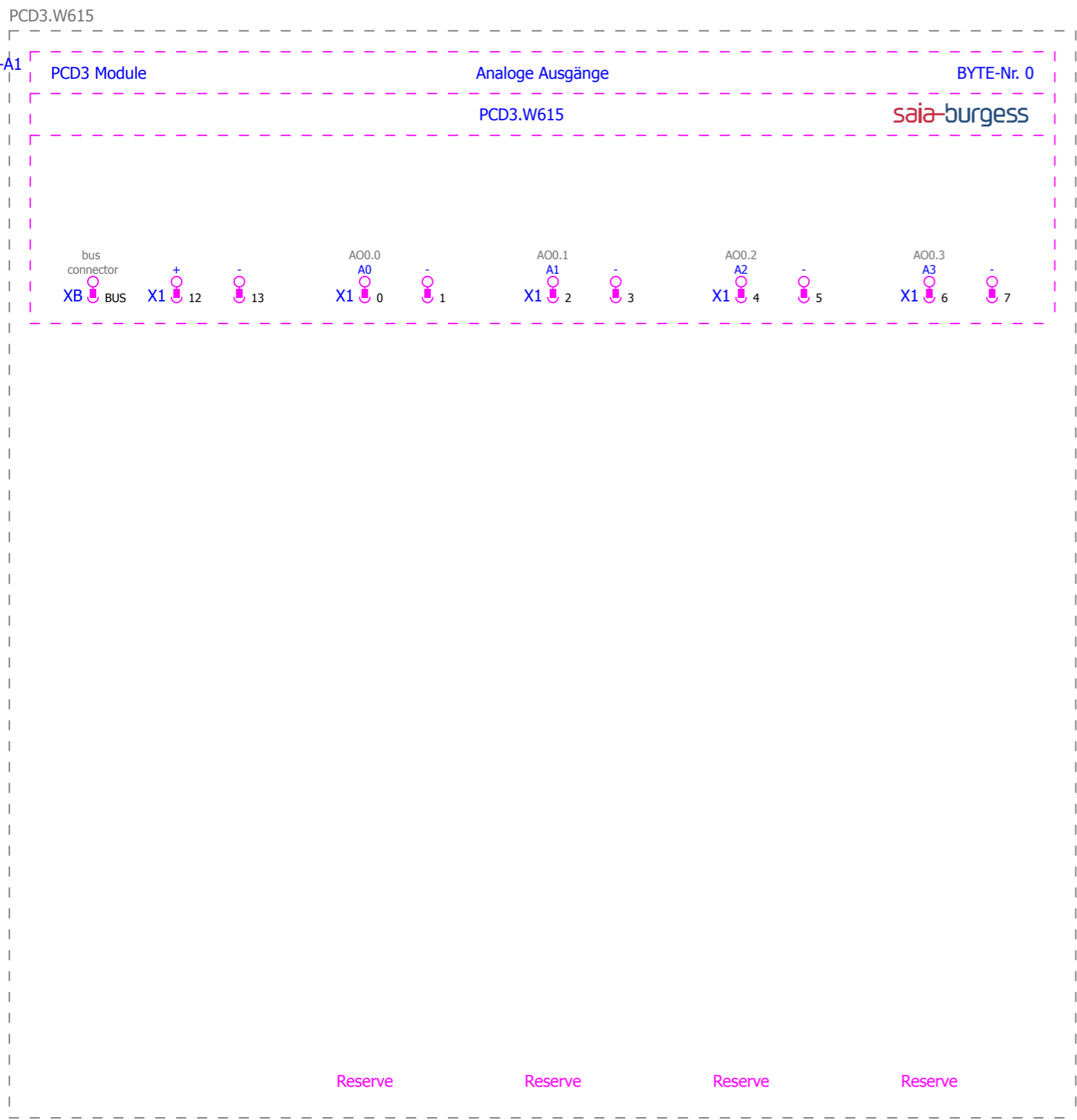

Saia-Burgess\PCD3 Module\PCD3.W615.ema
 Multi-line
 Variant A
 2012-10-26 / 2.1.4

+ .W605/10

10

			Datum	26.10.2012	EPLAN Software & Service Saia-Burgess Makroprojekt	 Control Systems and Components	Saia-Burgess Controls Ltd.	Allpolig		= PCD3 Module		
			Bearb.	KAF							+ PCD3.W615	
			Gepr									Blatt
Änderung	Datum	Name	Urspr		Ersatz von	Ersetzt durch					Blatt	522

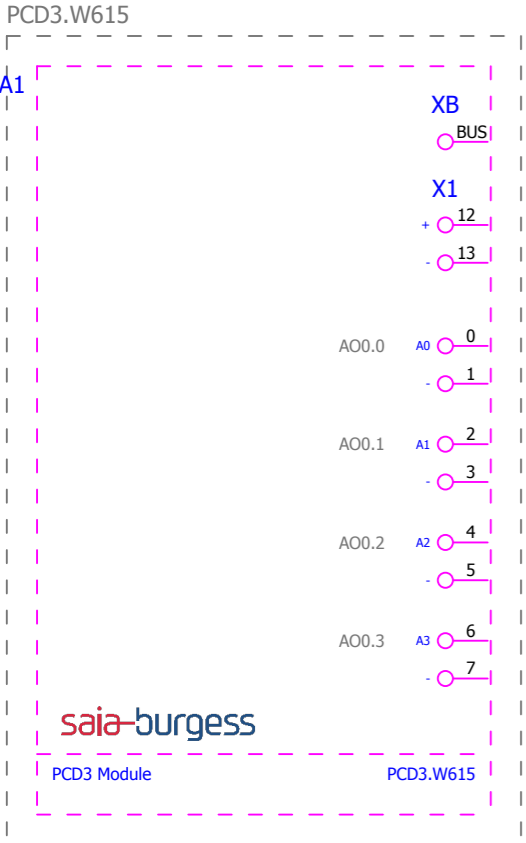

bus connector

Reserve

Reserve

Reserve

Reserve

Saia-Burgess\PCD3 Module\PCD3.W615.ema
 Overview
 Variant A
 2012-10-26 / 2.1.4

			Datum	26.10.2012	EPLAN Software & Service Saia-Burgess Makroprojekt	Saia-Burgess Controls Ltd. Control Systems and Components	Saia-Burgess Controls Ltd.	SPS-Übersicht	= PCD3 Module		Blatt 10
			Bearb.	KAF					+ PCD3.W615		
			Gepr								
Änderung	Datum	Name	Urspr		Ersatz von	Ersetzt durch				Blatt	522

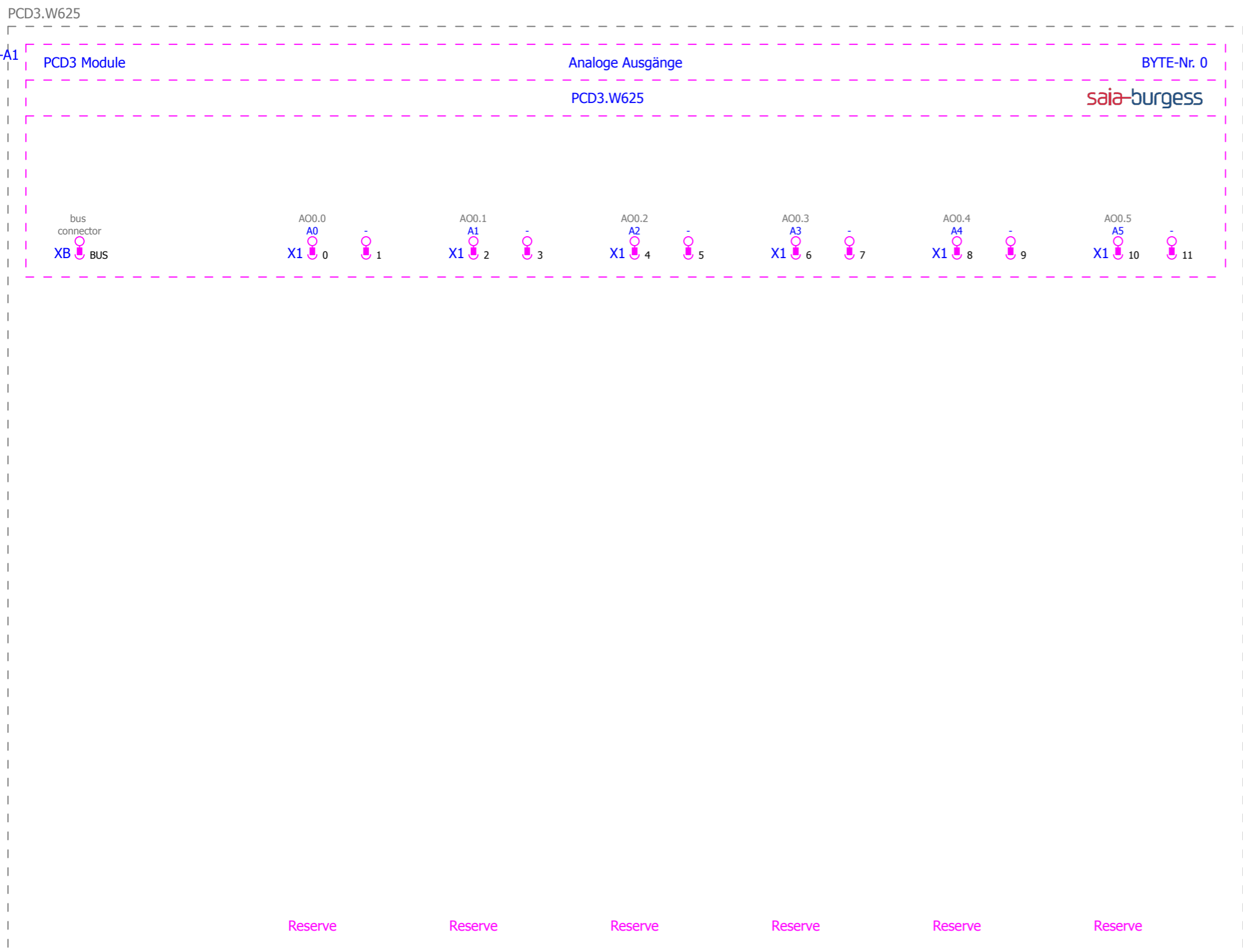

Saia-Burgess\PCD3 Module\PCD3.W625.ema
 Multi-line
 Variant A
 2012-10-26 / 2.1.4

+ .W615/10

10

			Datum	26.10.2012	EPLAN Software & Service Saia-Burgess Makroprojekt	Saia-Burgess Controls Ltd. <small>Control Systems and Components</small>	Allpolig	= PCD3 Module	
		Bearb.	KAF	+ PCD3.W625					
		Gepr		Blatt				1	
Änderung	Datum	Name	Urspr	Ersatz von	Ersetzt durch			Blatt	522

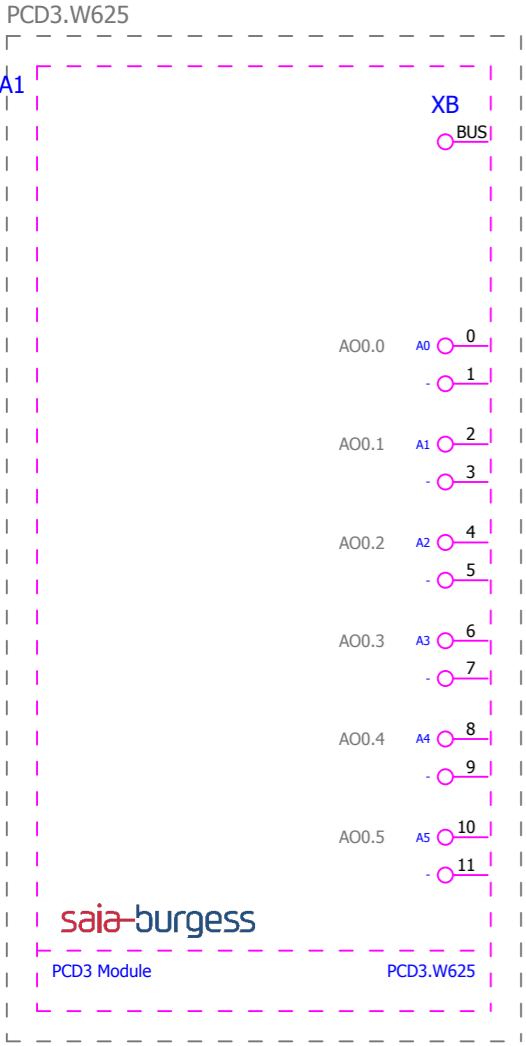

Saia-Burgess\PCD3 Module\PCD3.W625.ema
 Overview
 Variant A
 2012-10-26 / 2.1.4

			Datum	26.10.2012	EPLAN Software & Service Saia-Burgess Makroprojekt	Saia-Burgess Controls Ltd. Control Systems and Components	Saia-Burgess Controls Ltd.	SPS-Übersicht	= PCD3 Module		Blatt 10
		Bearb.	KAF	+ PCD3.W625							
		Gepr								Blatt 522	
Änderung	Datum	Name	Urspr		Ersatz von	Ersetzt durch					

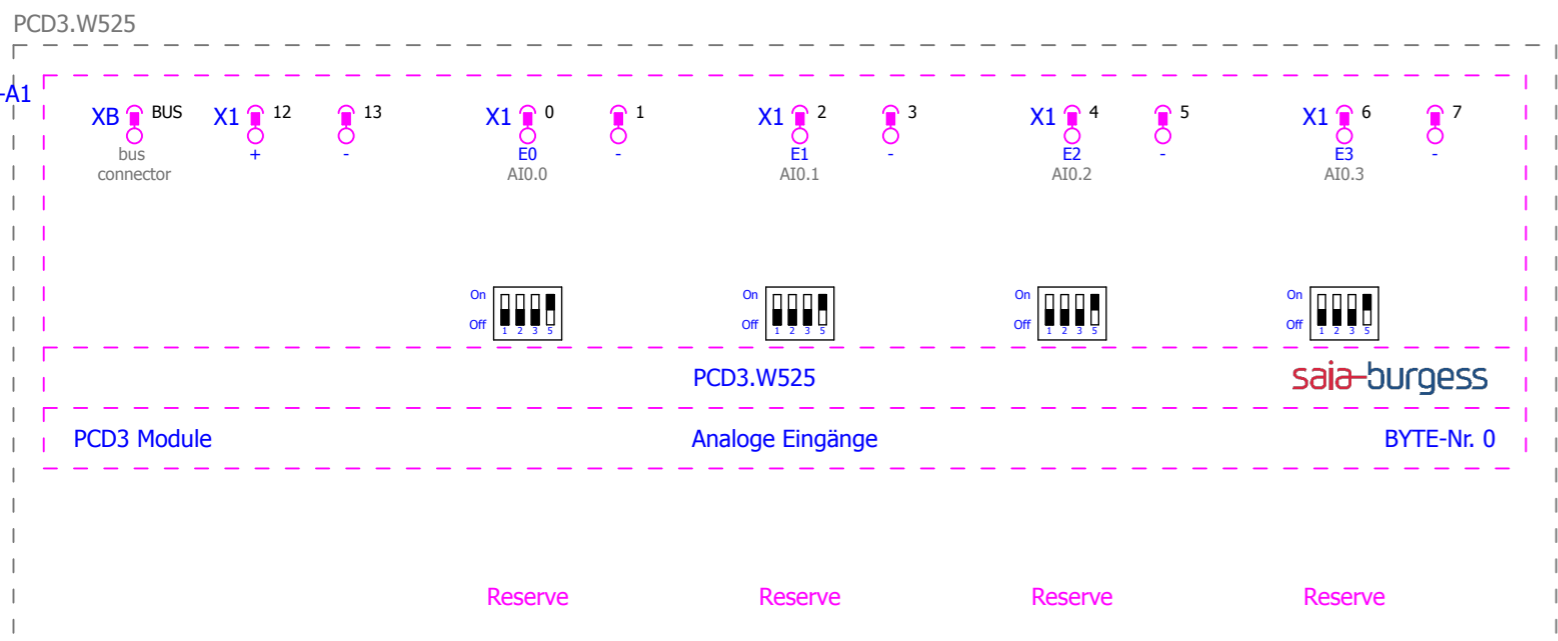

Saia-Burgess\PCD3 Module\PCD3.W525.ema
 Multi-line
 Variant A
 2012-10-26 / 2.1.4

+.W625/10

			Datum	26.10.2012	EPLAN Software & Service Saia-Burgess Makroprojekt	 Control Systems and Components	Saia-Burgess Controls Ltd.	Allpolig		= PCD3 Module		
			Bearb.	KAF							+ PCD3.W525	
			Gepr									Blatt
Änderung	Datum	Name	Urspr		Ersatz von	Ersetzt durch					Blatt	522

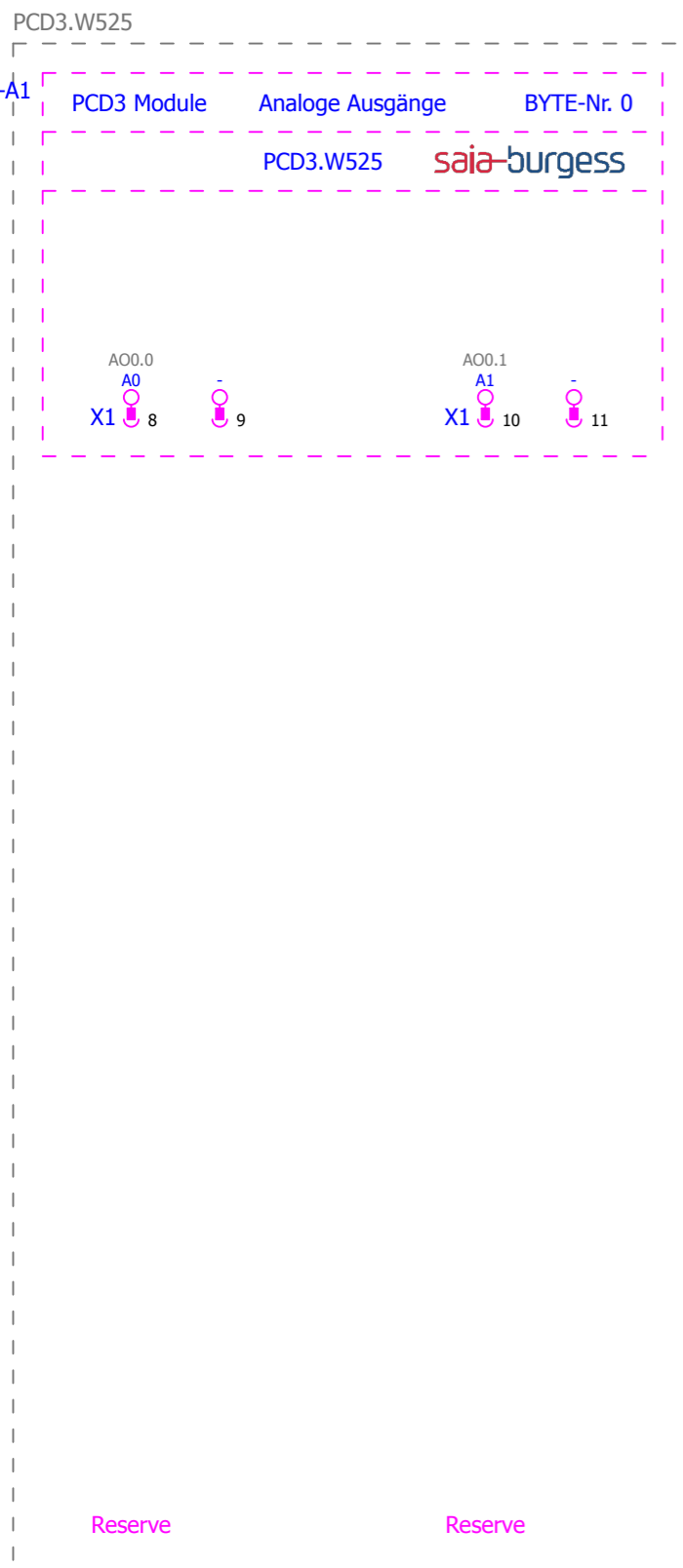

Saia-Burgess\PCD3 Module\PCD3.W525.ema
 Multi-line
 Variant B
 2012-10-26 / 2.1.4

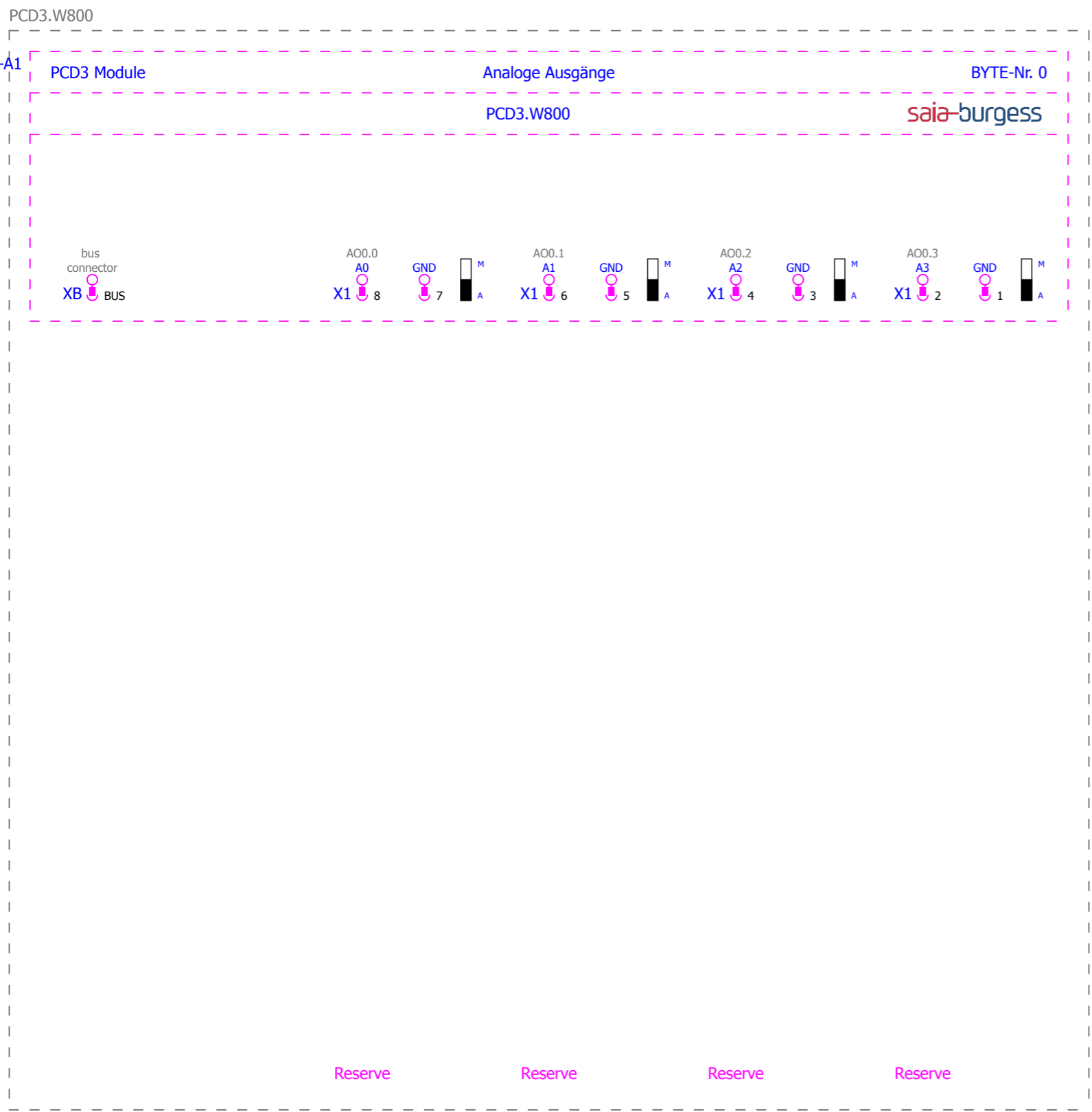

Saia-Burgess\PCD3 Module\PCD3.W800.ema
 Multi-line
 Variant A
 2012-10-26 / 2.1.4

+ .W525/10

			Datum	26.10.2012	EPLAN Software & Service Saia-Burgess Makroprojekt	 Control Systems and Components	Saia-Burgess Controls Ltd.	Allpolig	= PCD3 Module		Blatt 1
			Bearb.	KAF					+ PCD3.W800		
			Gepr								
Änderung	Datum	Name	Urspr		Ersatz von	Ersetzt durch			Blatt 522		

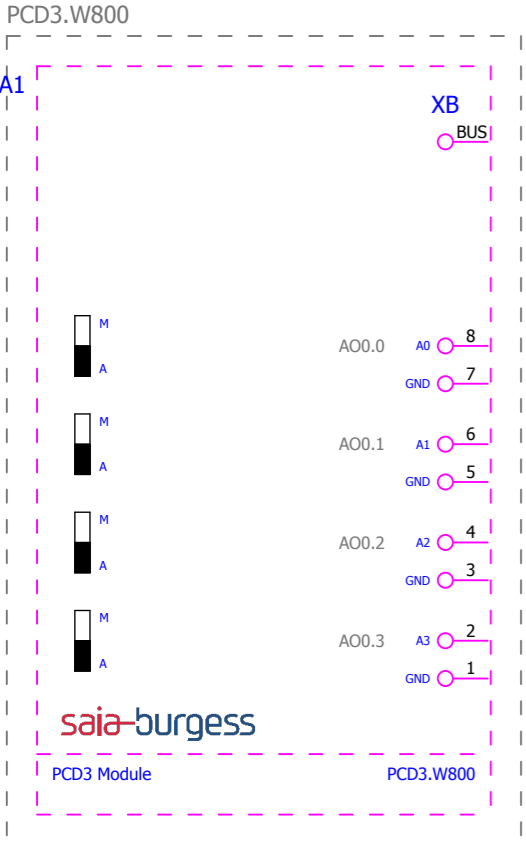

bus connector

Reserve

Reserve

Reserve

Reserve

Saia-Burgess\PCD3 Module\PCD3.W800.ema
 Overview
 Variant A
 2012-10-26 / 2.1.4

			Datum	26.10.2012	EPLAN Software & Service Saia-Burgess Makroprojekt	Saia-Burgess Controls Ltd. Control Systems and Components	Saia-Burgess Controls Ltd.	SPS-Übersicht	= PCD3 Module		Blatt 10
			Bearb.	KAF					+ PCD3.W800		
			Gepr								
Änderung	Datum	Name	Urspr		Ersatz von	Ersetzt durch				Blatt	522

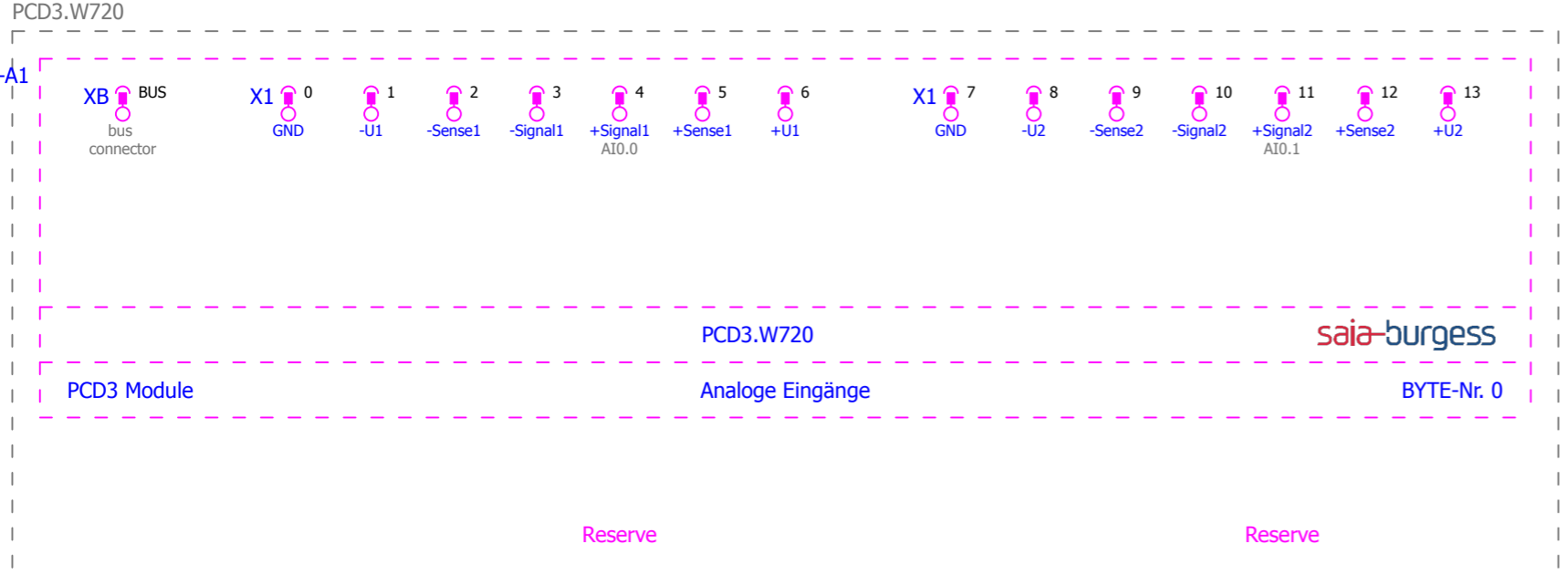

Saia-Burgess\PCD3 Module\PCD3.W720.ema
 Multi-line
 Variant A
 2012-10-26 / 2.1.4

			Datum	26.10.2012	EPLAN Software & Service Saia-Burgess Makroprojekt	 Control Systems and Components	Saia-Burgess Controls Ltd.	Allpolig			= PCD3 Module	
			Bearb.	KAF								+ PCD3.W720
			Gepr									
Änderung	Datum	Name	Urspr		Ersatz von	Ersetzt durch					Blatt 1	
											Blatt 522	



bus connector

Reserve

Reserve

Saia-Burgess\PCD3 Module\PCD3.W720.ema
 Overview
 Variant A
 2012-10-26 / 2.1.4

			Datum	26.10.2012	EPLAN Software & Service Saia-Burgess Makroprojekt	Saia-Burgess Controls Ltd. Control Systems and Components	Saia-Burgess Controls Ltd.	SPS-Übersicht	= PCD3 Module		Blatt 10
			Bearb.	KAF					+ PCD3.W720		
			Gepr								
Änderung	Datum	Name	Üspr		Ersatz von	Ersetzt durch				Blatt	522

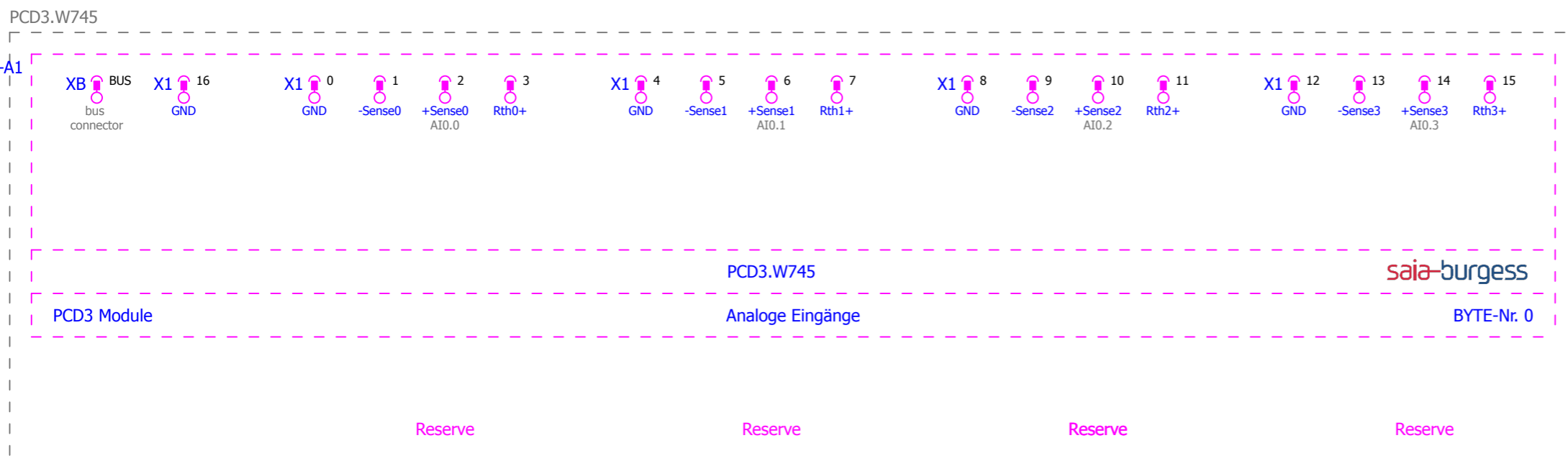

Saia-Burgess\PCD3 Module\PCD3.W745.ema
 Multi-line
 Variant A
 2012-10-26 / 2.1.4

+.W720/10

			Datum	26.10.2012	EPLAN Software & Service Saia-Burgess Makroprojekt	Saia-Burgess Controls Ltd. Control Systems and Components	Allpolig	= PCD3 Module	
			Bearb.	KAF				+ PCD3.W745	
			Gepr					Blatt	1
Änderung	Datum	Name	Urspr		Ersatz von	Ersetzt durch		Blatt	522



Saia-Burgess\PCD3 Module\PCD3.W745.ema
 Overview
 Variant A
 2012-10-26 / 2.1.4

bus connector

Reserve

Reserve

Reserve

Reserve

			Datum	26.10.2012	EPLAN Software & Service Saia-Burgess Makroprojekt	Saia-Burgess Controls Ltd.	SPS-Übersicht	= PCD3 Module		
			Bearb.	KAF				+ PCD3.W745		
			Gepr							Blatt
Änderung	Datum	Name	Üspr		Ersatz von	Ersetzt durch			Blatt	522

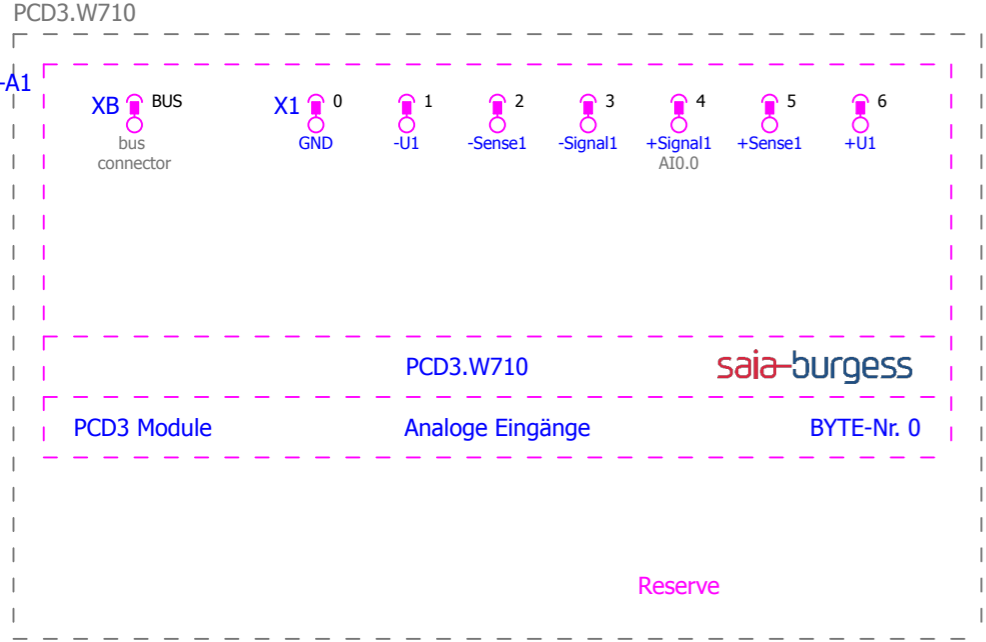

Saia-Burgess\PCD3 Module\PCD3.W710.ema
 Multi-line
 Variant A
 2012-10-26 / 2.1.4

+.W745/10

			Datum	26.10.2012	EPLAN Software & Service Saia-Burgess Makroprojekt	 Control Systems and Components	Saia-Burgess Controls Ltd.	Allpolig		= PCD3 Module			
			Bearb.	KAF							+ PCD3.W710		
			Gepr										Blatt
Änderung	Datum	Name	Urspr		Ersatz von	Ersetzt durch					Blatt	522	

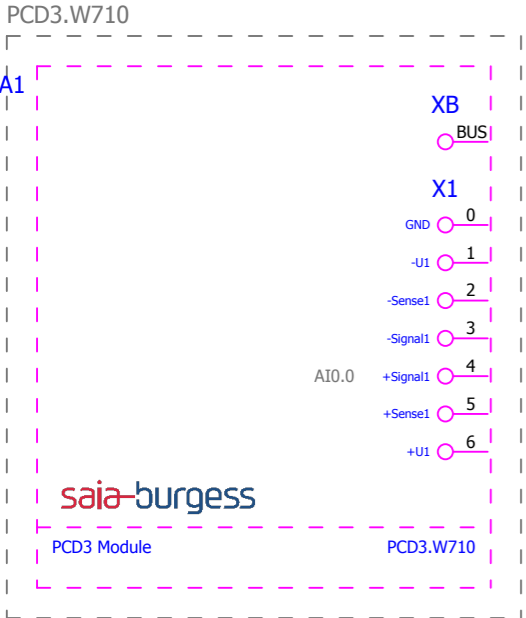

Saia-Burgess\PCD3 Module\PCD3.W710.ema
 Overview
 Variant A
 2012-10-26 / 2.1.4

			Datum	26.10.2012	EPLAN Software & Service Saia-Burgess Makroprojekt	Saia-Burgess Controls Ltd. Control Systems and Components	Saia-Burgess Controls Ltd.	SPS-Übersicht	= PCD3 Module		Blatt 10
		Bearb.	KAF	+ PCD3.W710							
		Gepr									
Änderung	Datum	Name	Urspr		Ersatz von	Ersetzt durch				Blatt 522	

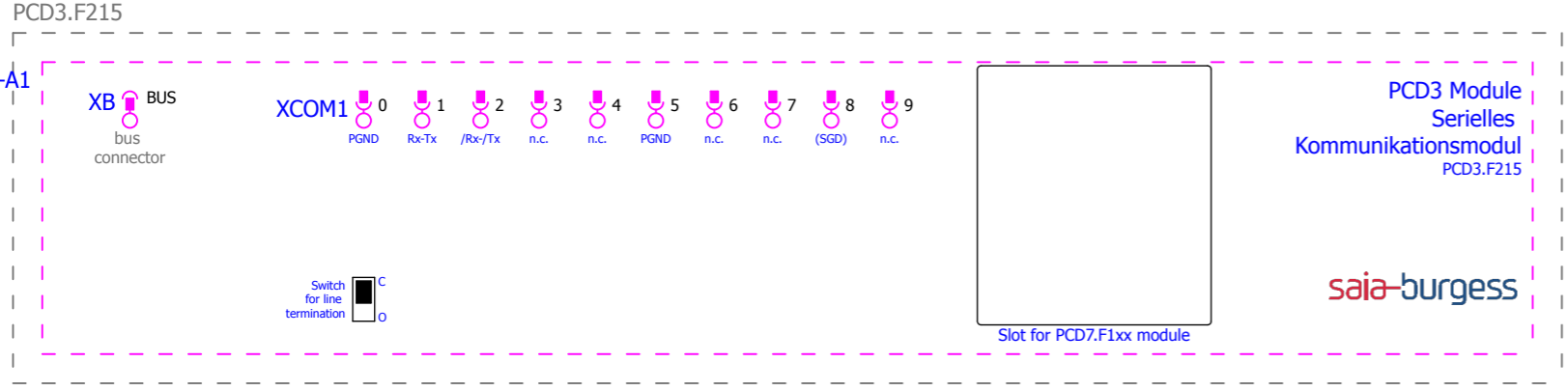

Saia-Burgess\PCD3 Module\PCD3.F215.ema
 Multi-line
 Variant A
 2012-10-26 / 2.1.4

			Datum	26.10.2012	EPLAN Software & Service Saia-Burgess Makroprojekt	 Control Systems and Components	Saia-Burgess Controls Ltd.	Allpolig	= PCD3 Module	
			Bearb.	KAF					+ PCD3.F215	
			Gepr						Blatt	1
Änderung	Datum	Name	Urspr		Ersatz von	Ersetzt durch			Blatt	522

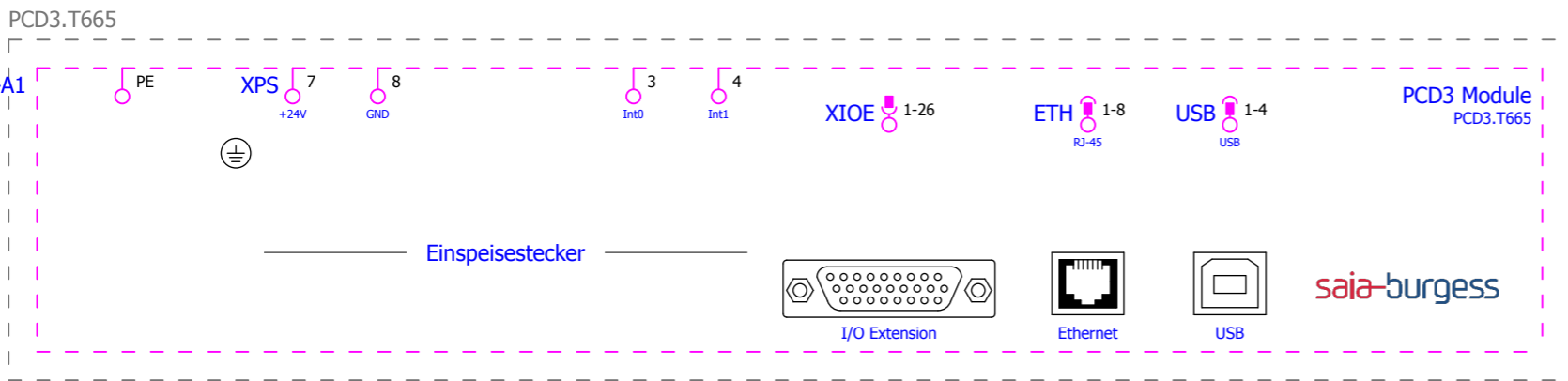

Saia-Burgess\PCD3 Module\PCD3.T665.ema
 Multi-line
 Variant A
 2012-10-26 / 2.1.4

			Datum	26.10.2012	EPLAN Software & Service Saia-Burgess Makroprojekt	 Control Systems and Components	Saia-Burgess Controls Ltd.	Allpolig		= PCD3 Module	
			Bearb.	KAF						+ PCD3.T665	
			Gepr								Blatt
Änderung	Datum	Name	Urspr		Ersatz von	Ersetzt durch				Blatt	522

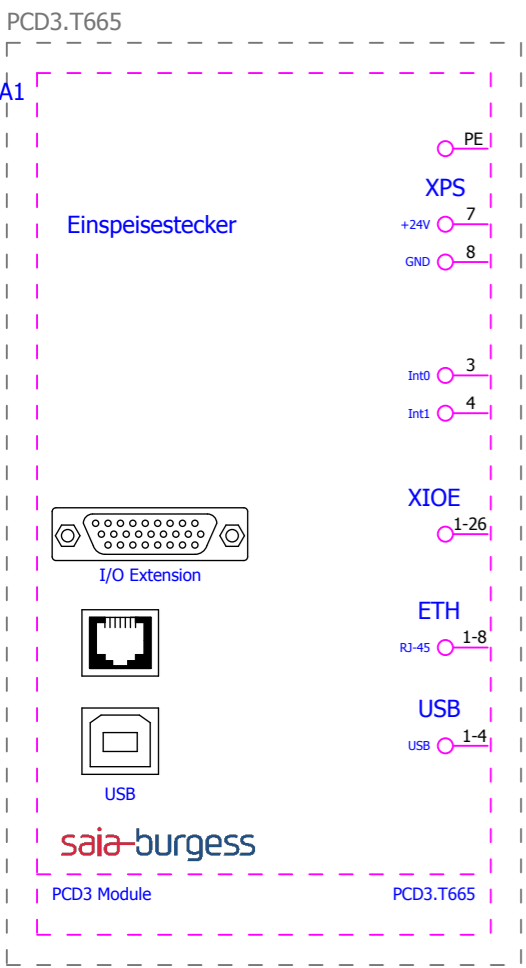

Saia-Burgess\PCD3 Module\PCD3.T665.ema
 Overview
 Variant A
 2012-10-26 / 2.1.4

			Datum	26.10.2012	EPLAN Software & Service Saia-Burgess Makroprojekt	Saia-Burgess Controls Ltd. Control Systems and Components	Saia-Burgess Controls Ltd.	SPS-Übersicht	= PCD3 Module		Blatt 10
		Bearb.	KAF	+ PCD3.T665							
		Gepr									
Änderung	Datum	Name	Urspr		Ersatz von	Ersetzt durch				Blatt	522

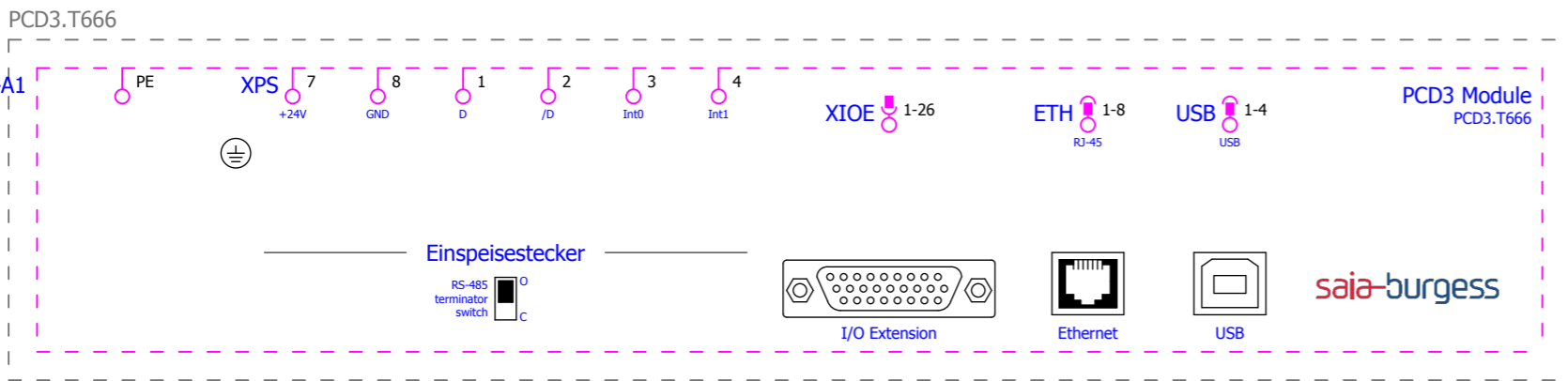

Saia-Burgess\PCD3 Module\PCD3.T666.ema
 Multi-line
 Variant A
 2012-10-26 / 2.1.4

			Datum	26.10.2012	EPLAN Software & Service Saia-Burgess Makroprojekt	Saia-Burgess Controls Ltd. Control Systems and Components	Allpolig	= PCD3 Module		
		Bearb.	KAF	+ PCD3.T666						
		Gepr						Blatt	1	
Änderung	Datum	Name	Urspr		Ersatz von	Ersetzt durch			Blatt	522

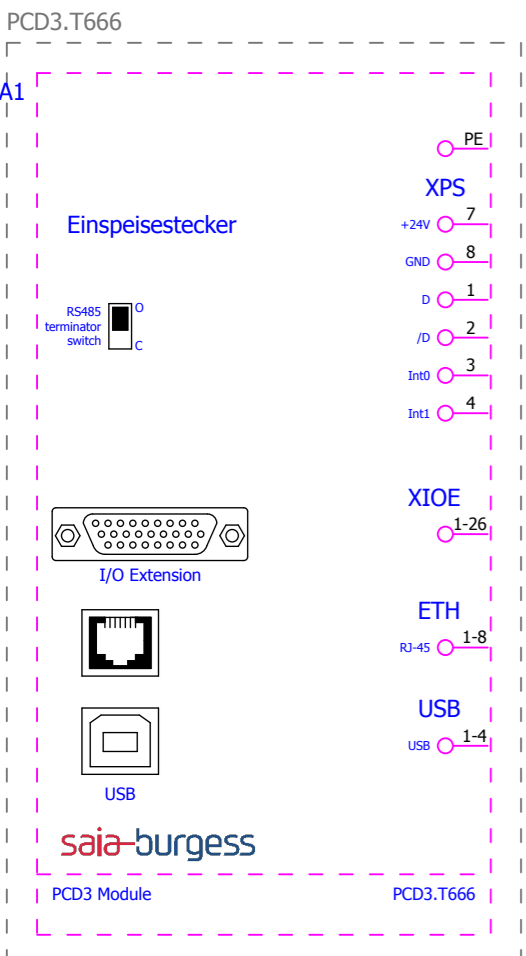

Saia-Burgess\PCD3 Module\PCD3.T666.ema
 Overview
 Variant A
 2012-10-26 / 2.1.4

=PCD3 CPU+.M2130V6/1

1

			Datum	26.10.2012	EPLAN Software & Service Saia-Burgess Makroprojekt	Saia-Burgess Controls Ltd. Control Systems and Components	Saia-Burgess Controls Ltd.	SPS-Übersicht	= PCD3 Module		Blatt 10
		Bearb.	KAF	+ PCD3.T666							
		Gepr									
Änderung	Datum	Name	Urspr		Ersatz von	Ersetzt durch				Blatt	522

PCD3.M2130V6

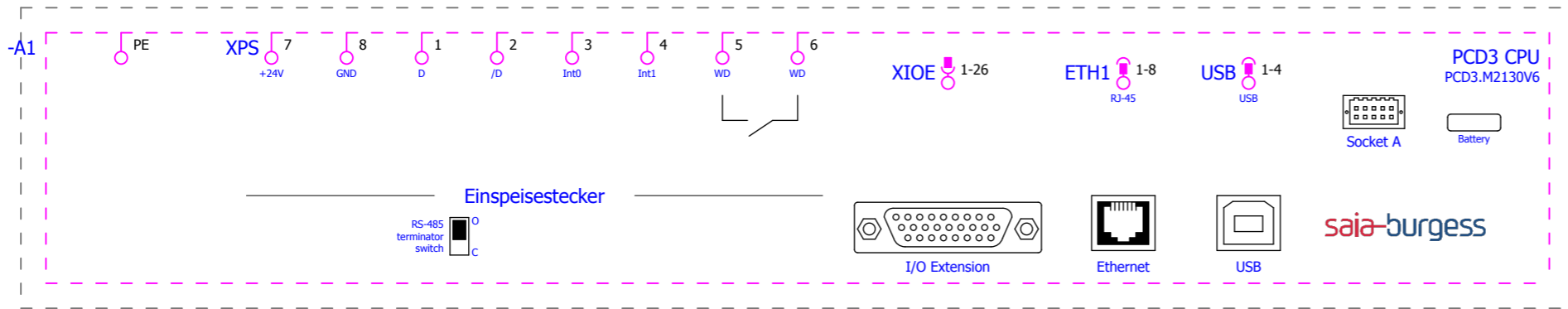

Saia-Burgess\PCD3 CPU\PCD3.M2130V6.ema
 Multi-line
 Variant A
 2012-10-26 / 2.1.4

=PCD3 Module+.T666/10

			Datum	26.10.2012	EPLAN Software & Service Saia-Burgess Makroprojekt	Saia-Burgess Controls Ltd. Control Systems and Components	Saia-Burgess Controls Ltd.	Allpolig	= PCD3 CPU	
			Bearb.	KAF					+ PCD3.M2130V6	
			Gepr						Blatt	1
Änderung	Datum	Name	Urspr		Ersatz von	Ersetzt durch			Blatt	522

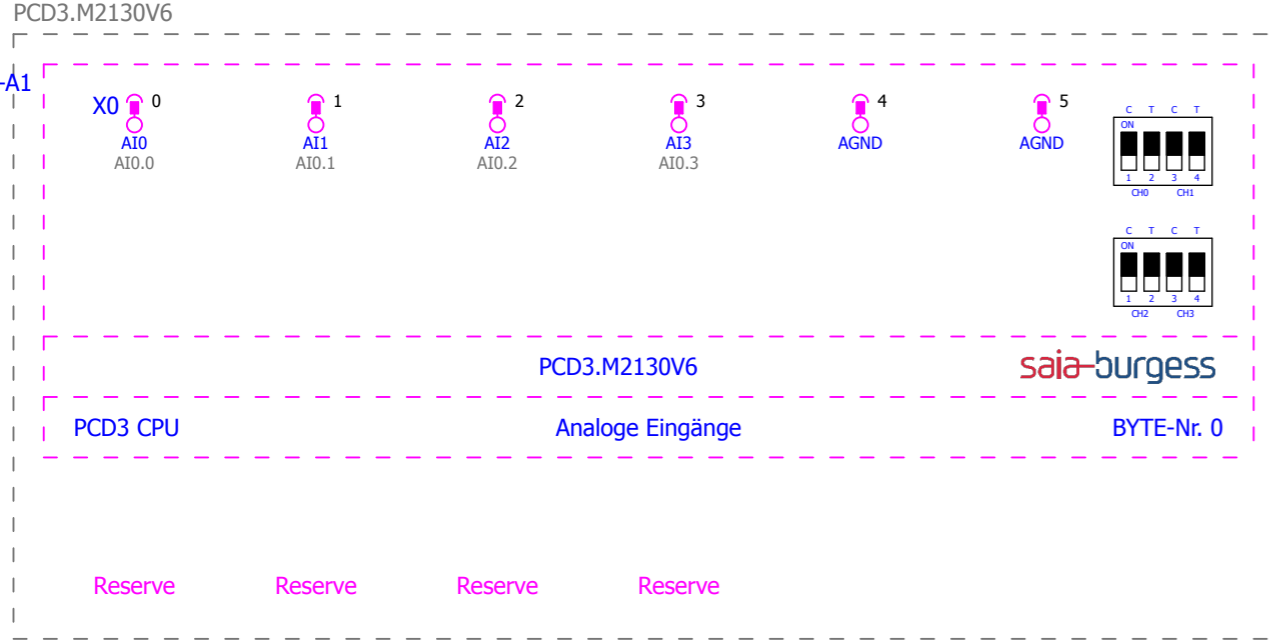

Saia-Burgess\PCD3 CPU\PCD3.M2130V6.ema
 Multi-line
 Variant B
 2012-10-26 / 2.1.4

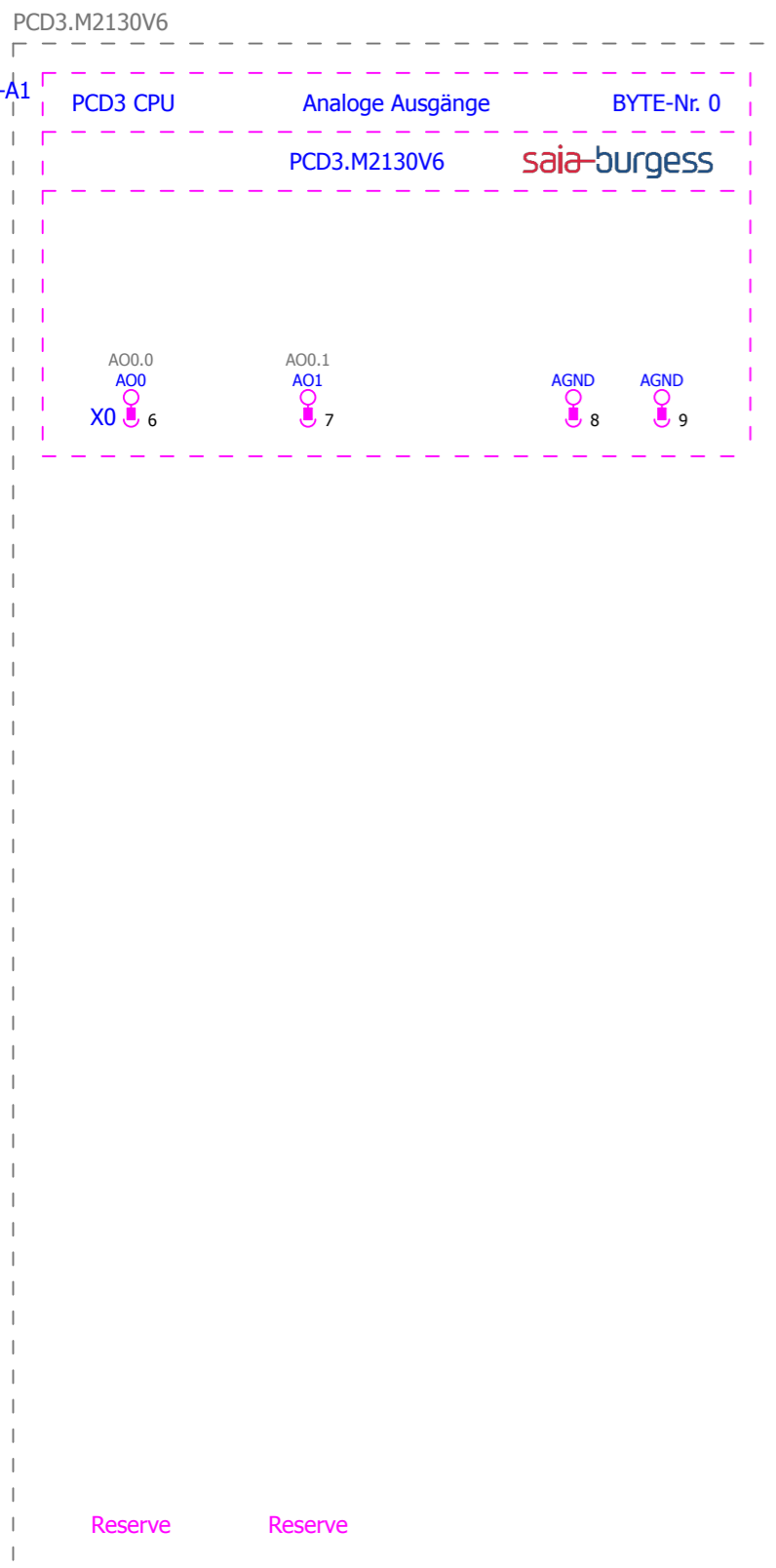

Saia-Burgess\PCD3 CPU\PCD3.M2130V6.ema
 Multi-line
 Variant C
 2012-10-26 / 2.1.4

			Datum	26.10.2012	EPLAN Software & Service Saia-Burgess Makroprojekt <small>Control Systems and Components</small>	Saia-Burgess Controls Ltd.	Allpolig	= PCD3 CPU	
			Bearb.	KAF				+ PCD3.M2130V6	
			Gepr					Blatt	3
Änderung	Datum	Name	Urspr		Ersatz von	Ersetzt durch		Blatt	522

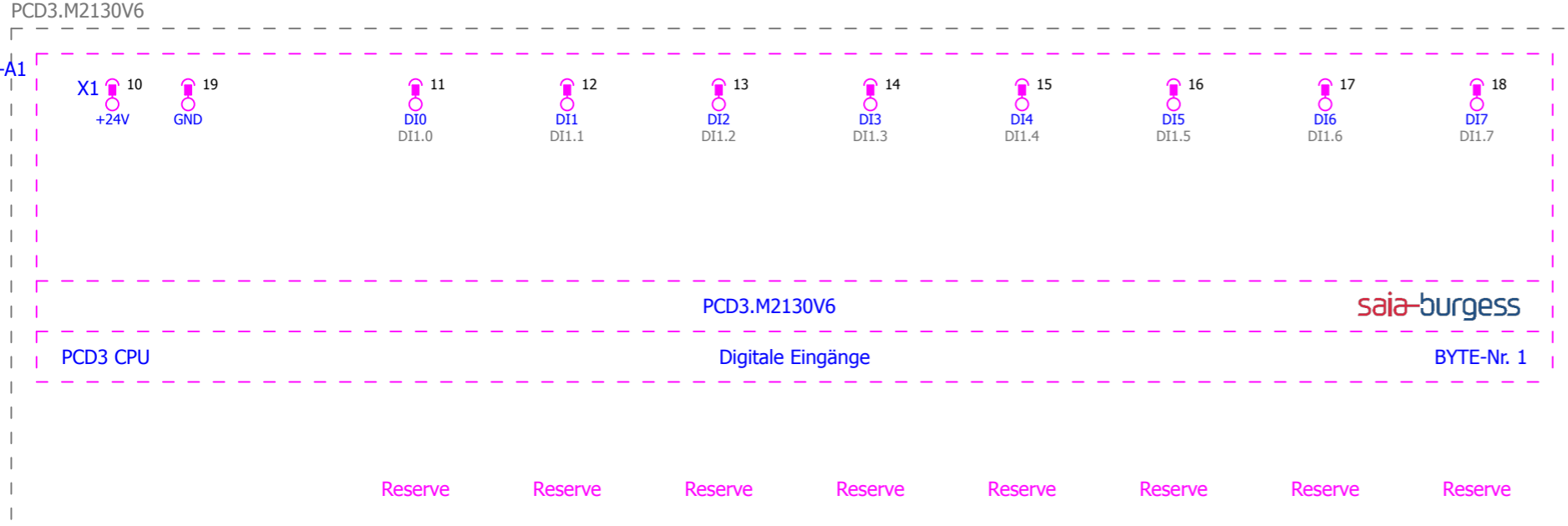

Saia-Burgess\PCD3 CPU\PCD3.M2130V6.ema
 Multi-line
 Variant D
 2012-10-26 / 2.1.4

			Datum	26.10.2012	EPLAN Software & Service Saia-Burgess Makroprojekt	 Control Systems and Components	Saia-Burgess Controls Ltd.		Allpolig		= PCD3 CPU	
			Bearb.	KAF							+ PCD3.M2130V6	
			Gepr								Blatt 4	
Änderung	Datum	Name	Urspr		Ersatz von	Ersetzt durch					Blatt 522	

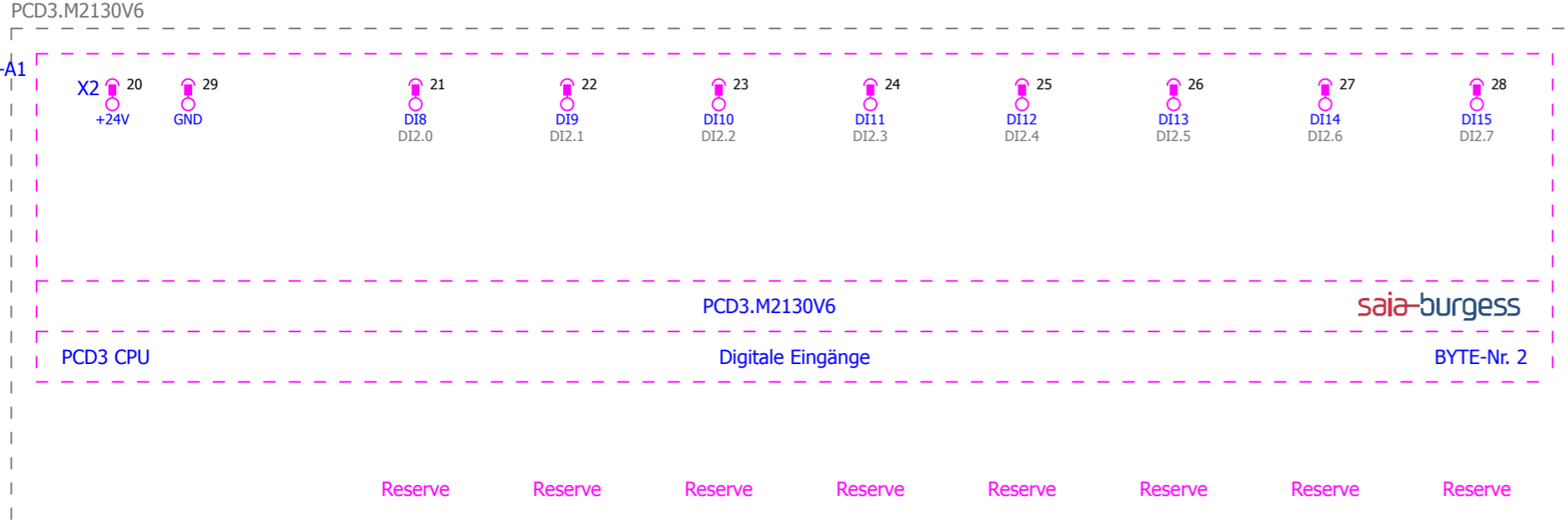

Saia-Burgess\PCD3 CPU\PCD3.M2130V6.ema
 Multi-line
 Variant E
 2012-10-26 / 2.1.4

				EPLAN Software & Service		Saia-Burgess Controls Ltd.		Allpolig		= PCD3 CPU	
				EPLAN Saia-Burgess Makroprojekt		Control Systems and Components				+ PCD3.M2130V6	
				Ersatz von		Ersetzt durch				Blatt 5	
Änderung				Datum		Name		Urspr		Blatt 522	



Saia-Burgess\PCD3 CPU\PCD3.M2130V6.ema
Multi-line
Variant G
2012-10-26 / 2.1.4

6		8		= PCD3 CPU		Blatt 7	
				+ PCD3.M2130V6		Blatt 522	
Datum		26.10.2012		EPLAN Software & Service		Saia-Burgess Controls Ltd.	
Bearb.		KAF		Saia-Burgess Makroprojekt		Allpolig	
Gepr				EPLAN			
Änderung		Datum		Name		Urspr	
						Ersatz von	
						Ersetzt durch	

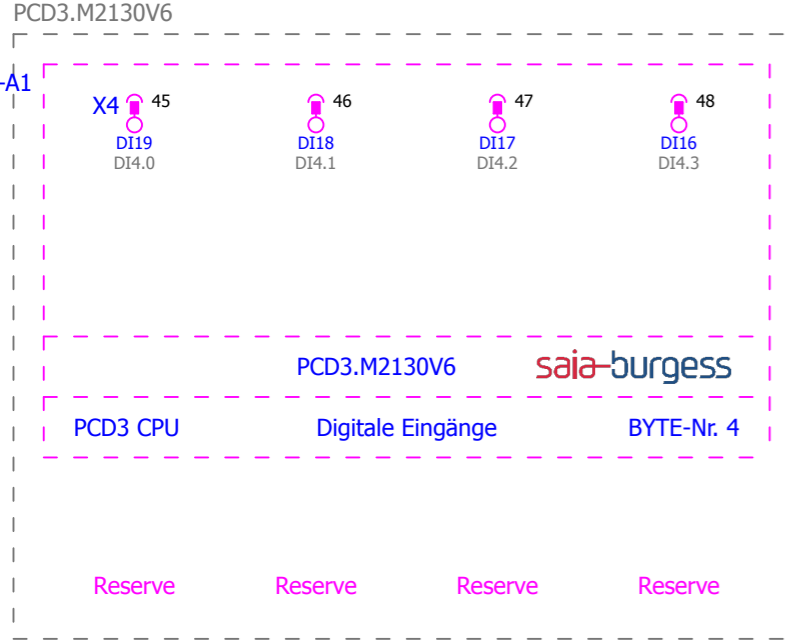

Saia-Burgess\PCD3 CPU\PCD3.M2130V6.ema
Multi-line
Variant H
2012-10-26 / 2.1.4

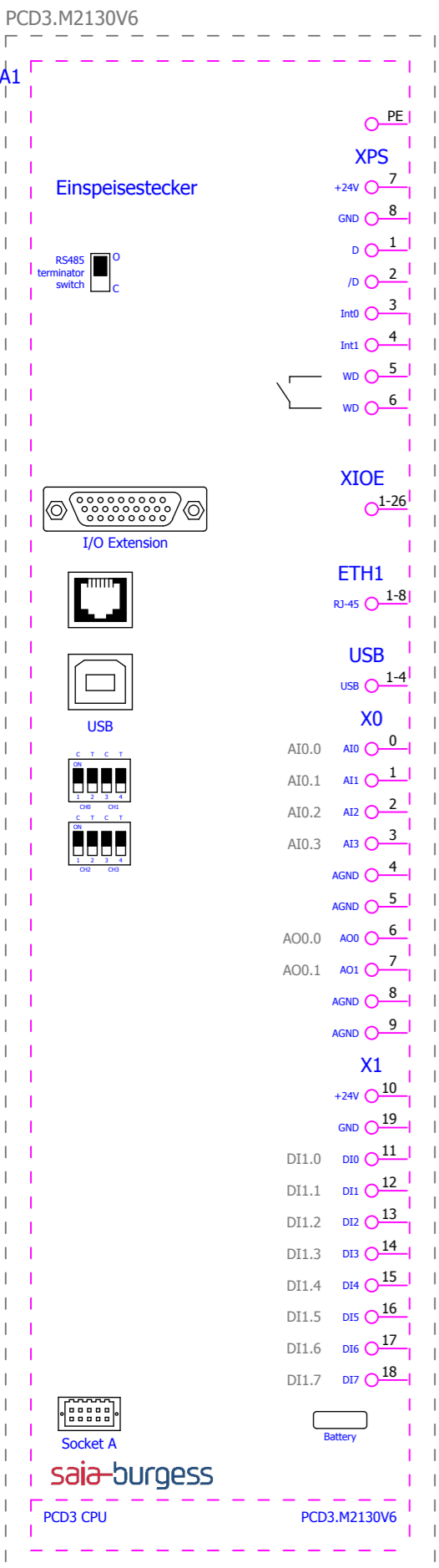

Saia-Burgess\PCD3 CPU\PCD3.M2130V6.ema
 Overview
 Variant A
 2012-10-26 / 2.1.4

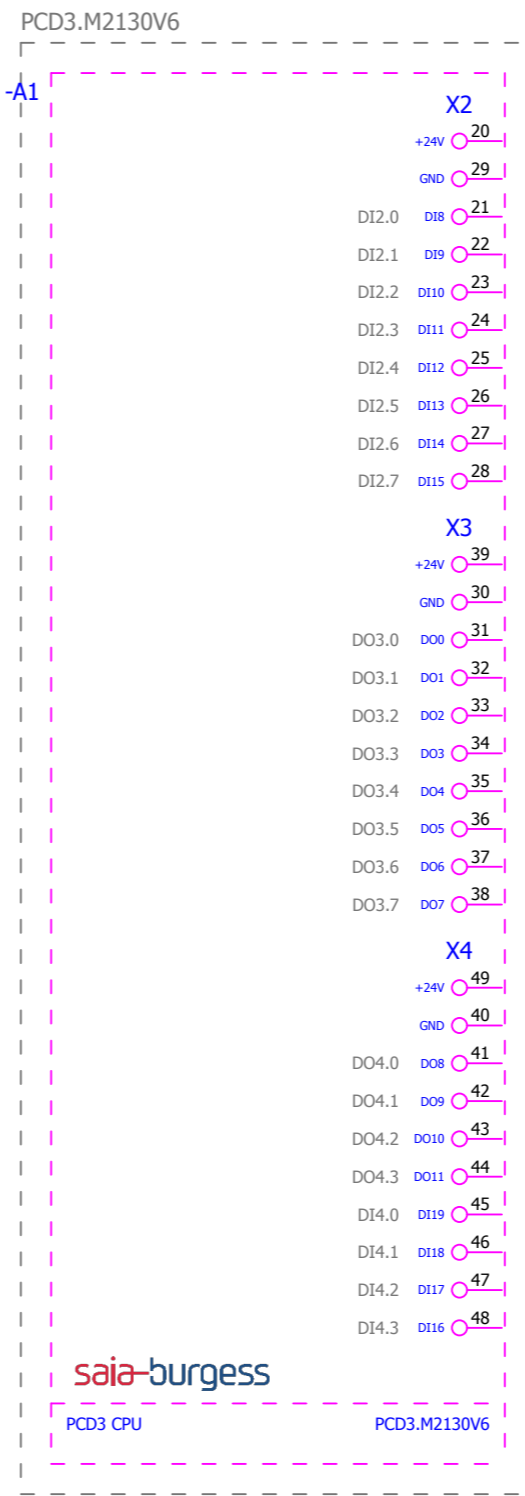

Saia-Burgess\PCD3 CPU\PCD3.M2130V6.ema
 Overview
 Variant B
 2012-10-26 / 2.1.4

Änderung	Datum	Name	Urspr
----------	-------	------	-------

Datum	26.10.2012
Bearb.	KAF
Gepr	

EPLAN Software & Service	
Saia-Burgess Makroprojekt	
Ersatz von	Ersetzt durch



Saia-Burgess Controls Ltd.

SPS-Übersicht

= PCD3 CPU
+ PCD3.M2130V6

Blatt	10
Blatt	522

PCD3.M2030V6

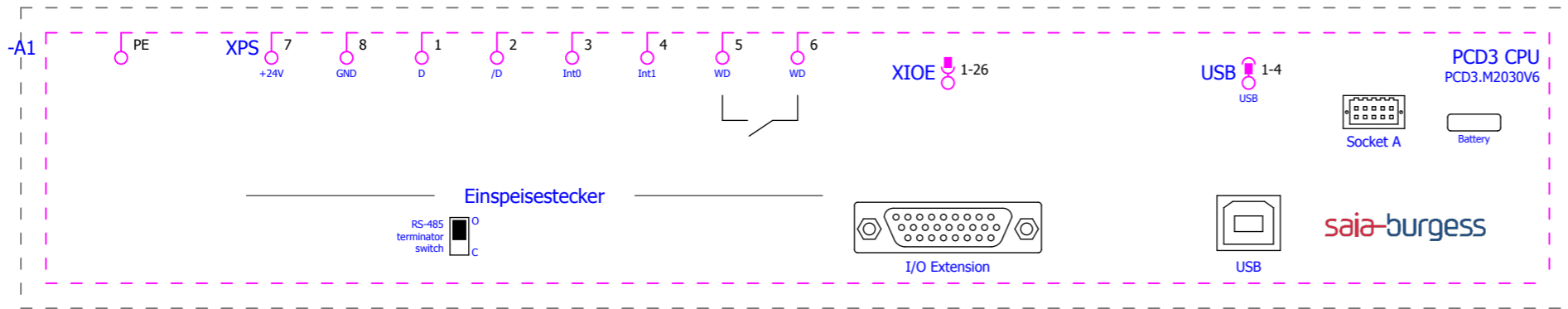

Saia-Burgess\PCD3 CPU\PCD3.M2030V6.ema
 Multi-line
 Variant A
 2012-10-26 / 2.1.4

			Datum	26.10.2012	EPLAN Software & Service Saia-Burgess Makroprojekt	Saia-Burgess Controls Ltd. Control Systems and Components	Saia-Burgess Controls Ltd.	Allpolig			= PCD3 CPU
			Bearb.	KAF							+ PCD3.M2030V6
			Gepr								Blatt
Änderung	Datum	Name	Urspr		Ersatz von	Ersetzt durch			Blatt	522	

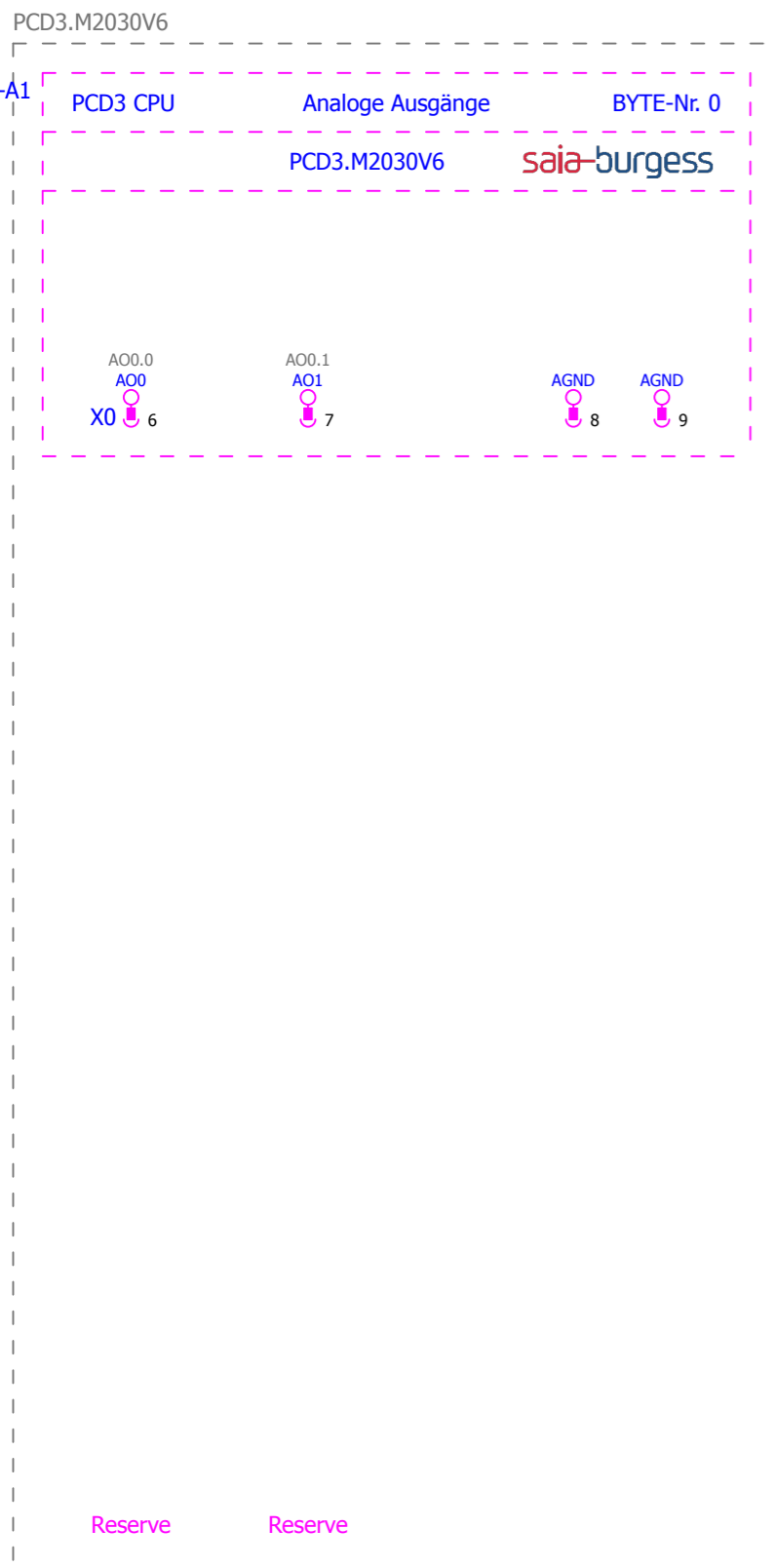

Saia-Burgess\PCD3 CPU\PCD3.M2030V6.ema
 Multi-line
 Variant C
 2012-10-26 / 2.1.4

			Datum	26.10.2012	EPLAN Software & Service Saia-Burgess Makroprojekt	Saia-Burgess Controls Ltd.	Allpolig	= PCD3 CPU	
			Bearb.	KAF				+ PCD3.M2030V6	
			Gepr					Blatt	3
Änderung	Datum	Name	Urspr	Ersatz von	Ersetzt durch			Blatt	522

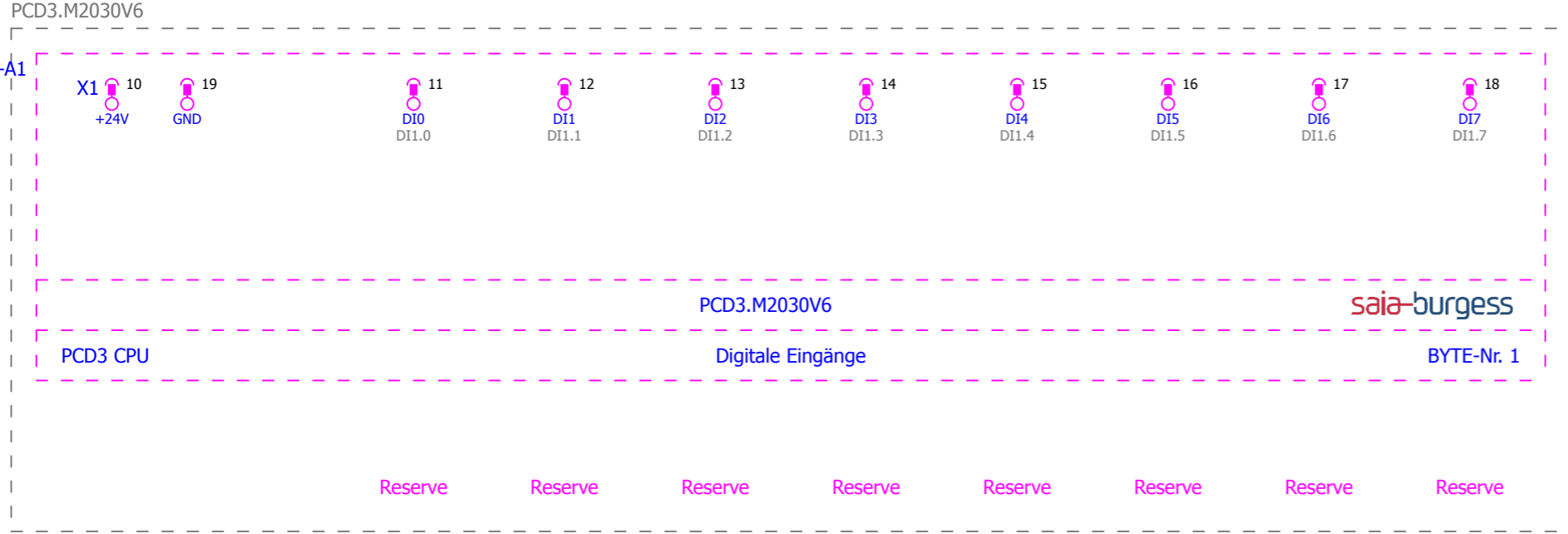

Saia-Burgess\PCD3 CPU\PCD3.M2030V6.ema
 Multi-line
 Variant D
 2012-10-26 / 2.1.4

			Datum	26.10.2012	EPLAN Software & Service Saia-Burgess Makroprojekt	Saia-Burgess Controls Ltd. Control Systems and Components	Allpolig	= PCD3 CPU		Blatt 4
			Bearb.	KAF				+ PCD3.M2030V6		
			Gepr							
Änderung	Datum	Name	Urspr	Ersatz von	Ersetzt durch			Blatt 522		

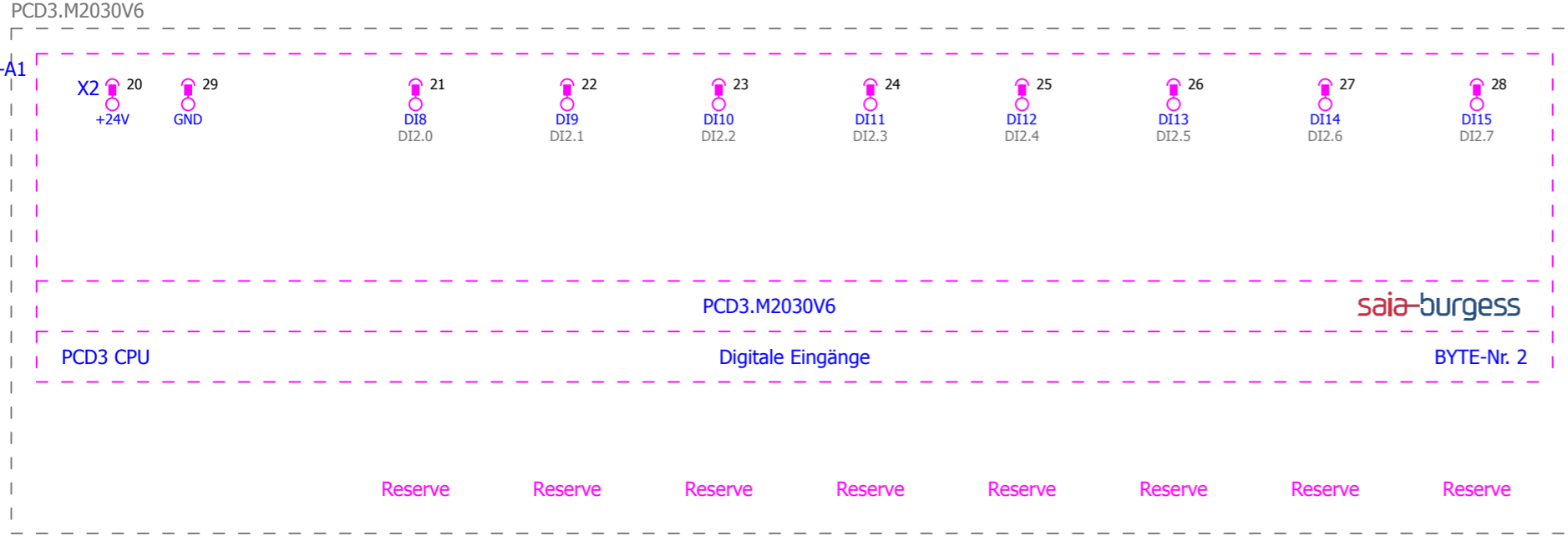

Saia-Burgess\PCD3 CPU\PCD3.M2030V6.ema
 Multi-line
 Variant E
 2012-10-26 / 2.1.4

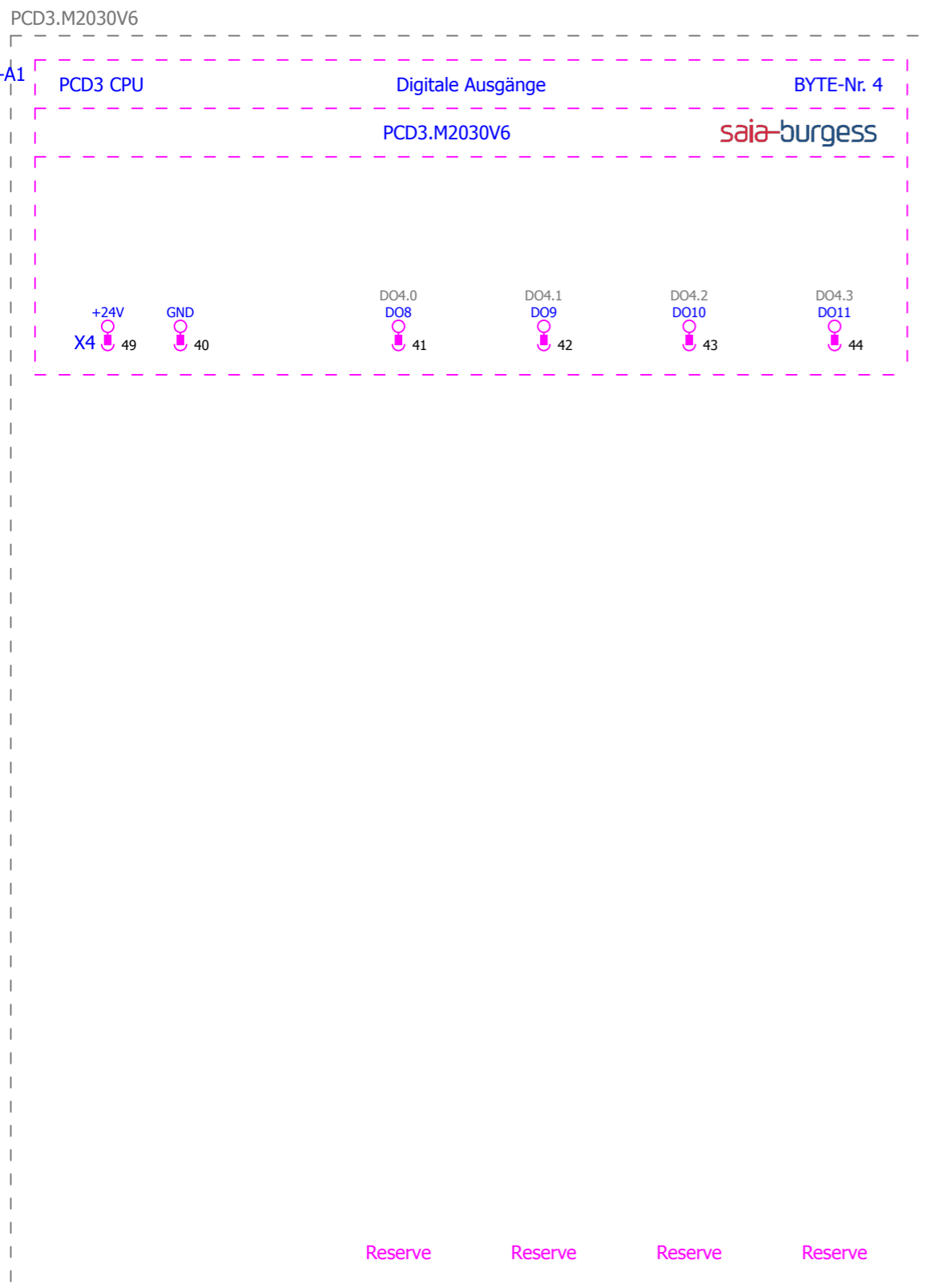

Saia-Burgess\PCD3 CPU\PCD3.M2030V6.ema
Multi-line
Variant G
2012-10-26 / 2.1.4

6		8					
Datum	26.10.2012	EPLAN Software & Service Saia-Burgess Makroprojekt <small>Control Systems and Components</small>	Saia-Burgess Controls Ltd. Allpolig				
Bearb.	KAF						
Gepr							
Änderung	Datum	Name	Urspr	Ersatz von	Ersetzt durch	= PCD3 CPU + PCD3.M2030V6	Blatt 7
							Blatt 522

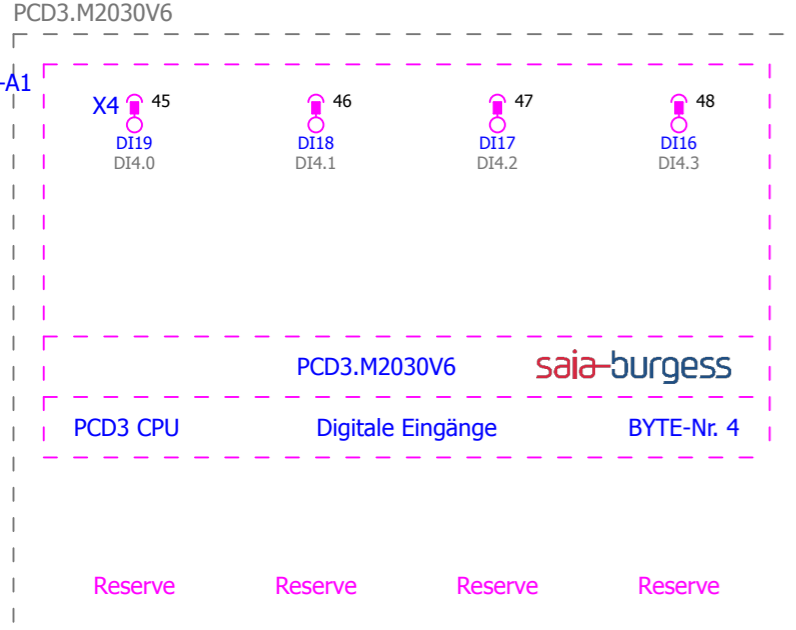

Saia-Burgess\PCD3 CPU\PCD3.M2030V6.ema
 Multi-line
 Variant H
 2012-10-26 / 2.1.4



Saia-Burgess\PCD3 CPU\PCD3.M2230A4T5.ema
 Multi-line
 Variant B
 2012-10-26 / 2.1.4

			Datum	26.10.2012	EPLAN Software & Service Saia-Burgess Makroprojekt	Saia-Burgess Controls Ltd. Control Systems and Components	Saia-Burgess Controls Ltd.	Allpolig	= PCD3 CPU	
			Bearb.	KAF					+ PCD3.M2230A4T5	
			Gepr						Blatt	2
Änderung	Datum	Name	Urspr	Ersatz von	Ersetzt durch				Blatt	522

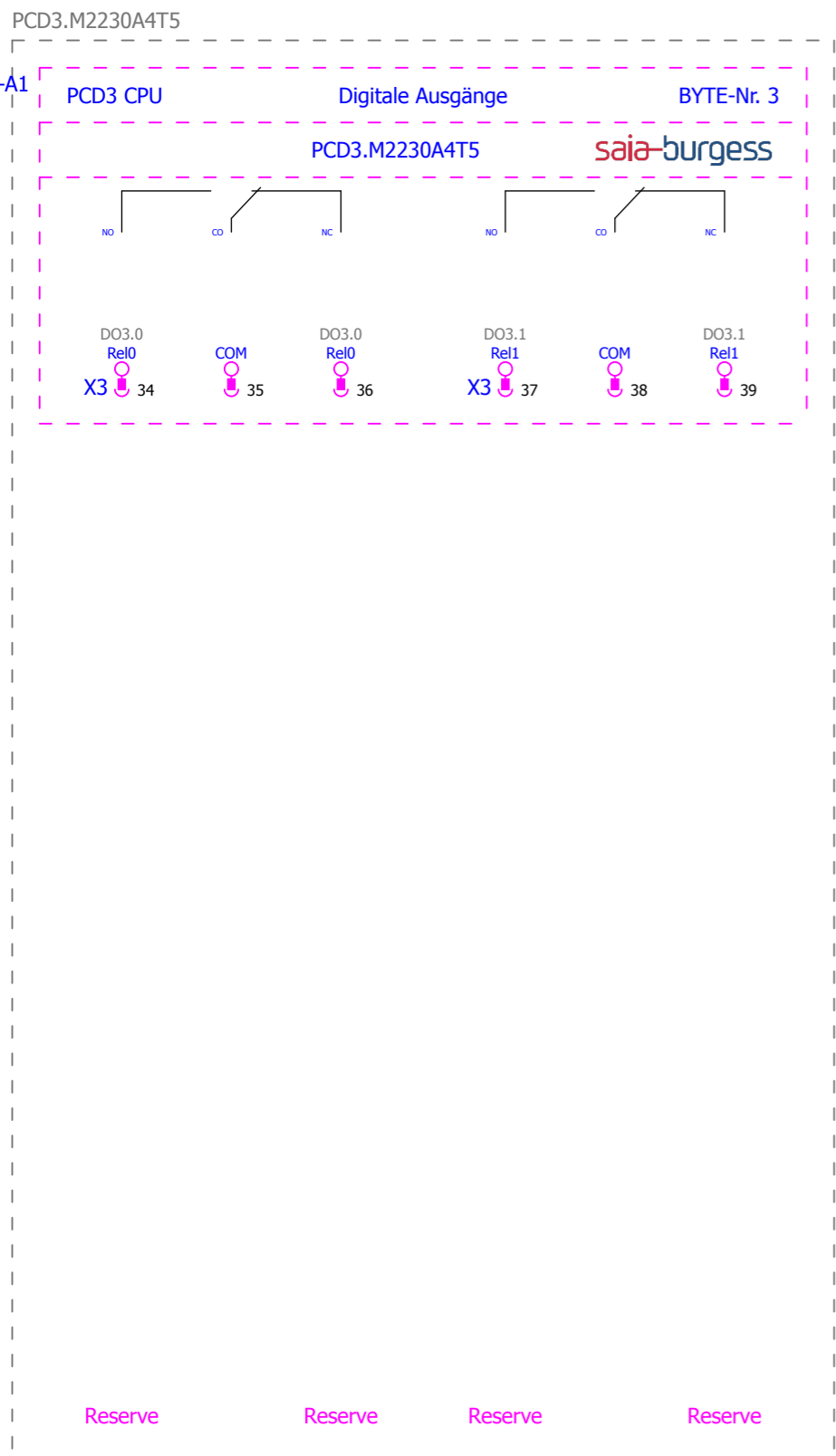

Saia-Burgess\PCD3 CPU\PCD3.M2230A4T5.ema
Multi-line
Variant D
2012-10-26 / 2.1.4

			Datum	26.10.2012	EPLAN Software & Service Saia-Burgess Makroprojekt	Saia-Burgess Controls Ltd. <small>Control Systems and Components</small>	Allpolig	= PCD3 CPU		Blatt 4
			Bearb.	KAF				+ PCD3.M2230A4T5		
			Gepr							
Änderung	Datum	Name	Urspr	Ersatz von	Ersetzt durch			Blatt 522		

PCD3.M2330A4T1

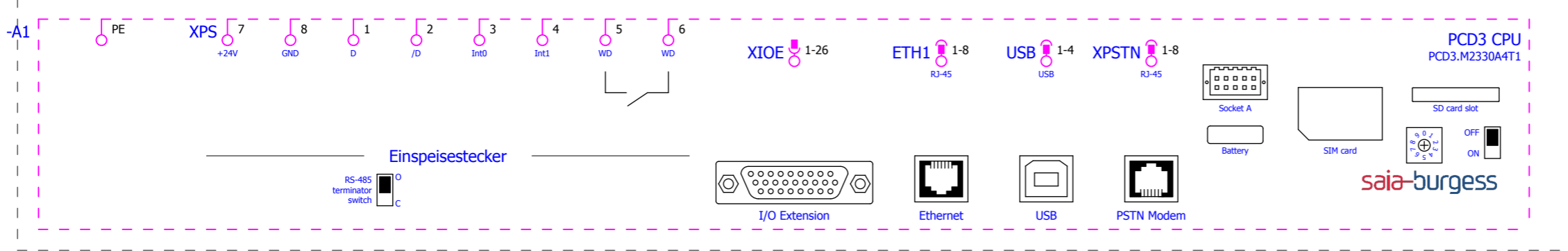

Saia-Burgess\PCD3 CPU\PCD3.M2330A4T1.ema
 Multi-line
 Variant A
 2012-10-26 / 2.1.4

			Datum	26.10.2012	EPLAN Software & Service Saia-Burgess Makroprojekt	Saia-Burgess Controls Ltd. Control Systems and Components	Saia-Burgess Controls Ltd.	Allpolig	= PCD3 CPU	
			Bearb.	KAF					+ PCD3.M2330A4T1	
			Gepr						Blatt	1
Änderung	Datum	Name	Urspr		Ersatz von	Ersetzt durch			Blatt	522

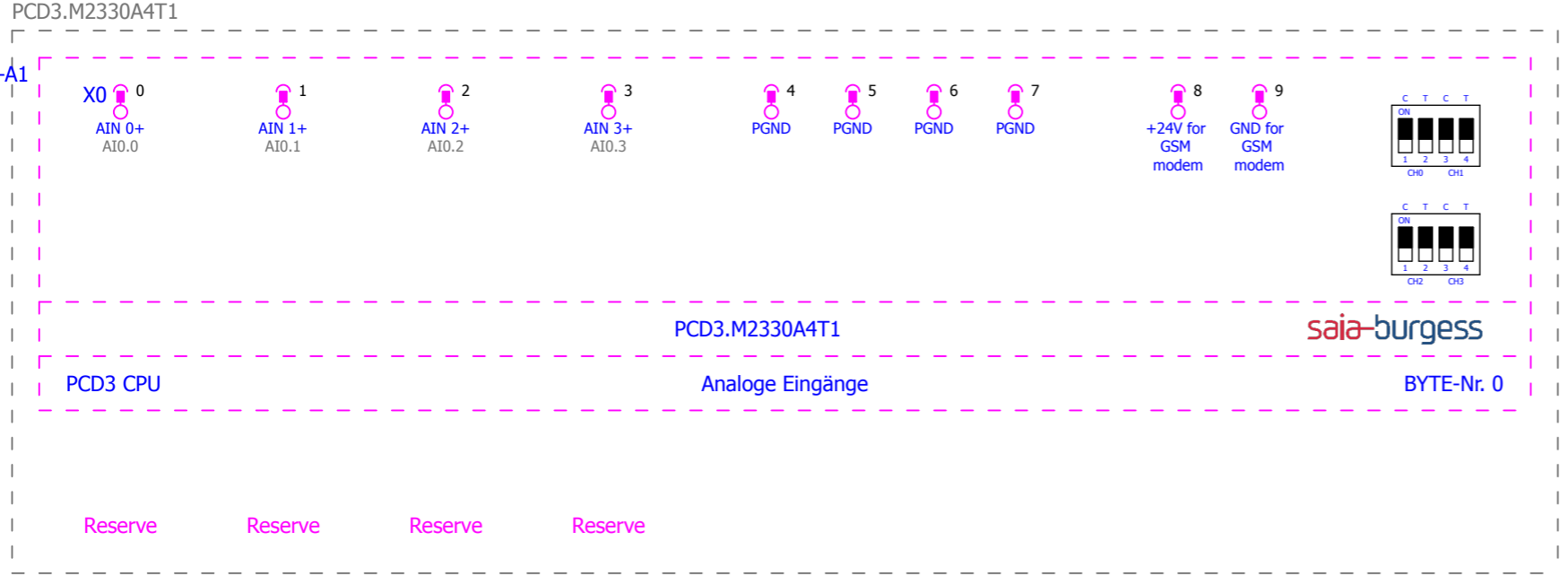

Saia-Burgess\PCD3 CPU\PCD3.M2330A4T1.ema
 Multi-line
 Variant B
 2012-10-26 / 2.1.4

1		3						
Datum	26.10.2012	EPLAN Software & Service	Saia-Burgess Controls Ltd.					
Bearb.	KAF	Saia-Burgess Makroprojekt						
Gepr								
Änderung	Datum	Name	Urspr	Ersatz von	Ersetzt durch	Allpolig	= PCD3 CPU + PCD3.M2330A4T1	Blatt 2
								Blatt 522



Saia-Burgess\PCD3 CPU\PCD3.M2330A4T1.ema
 Multi-line
 Variant C
 2012-10-26 / 2.1.4

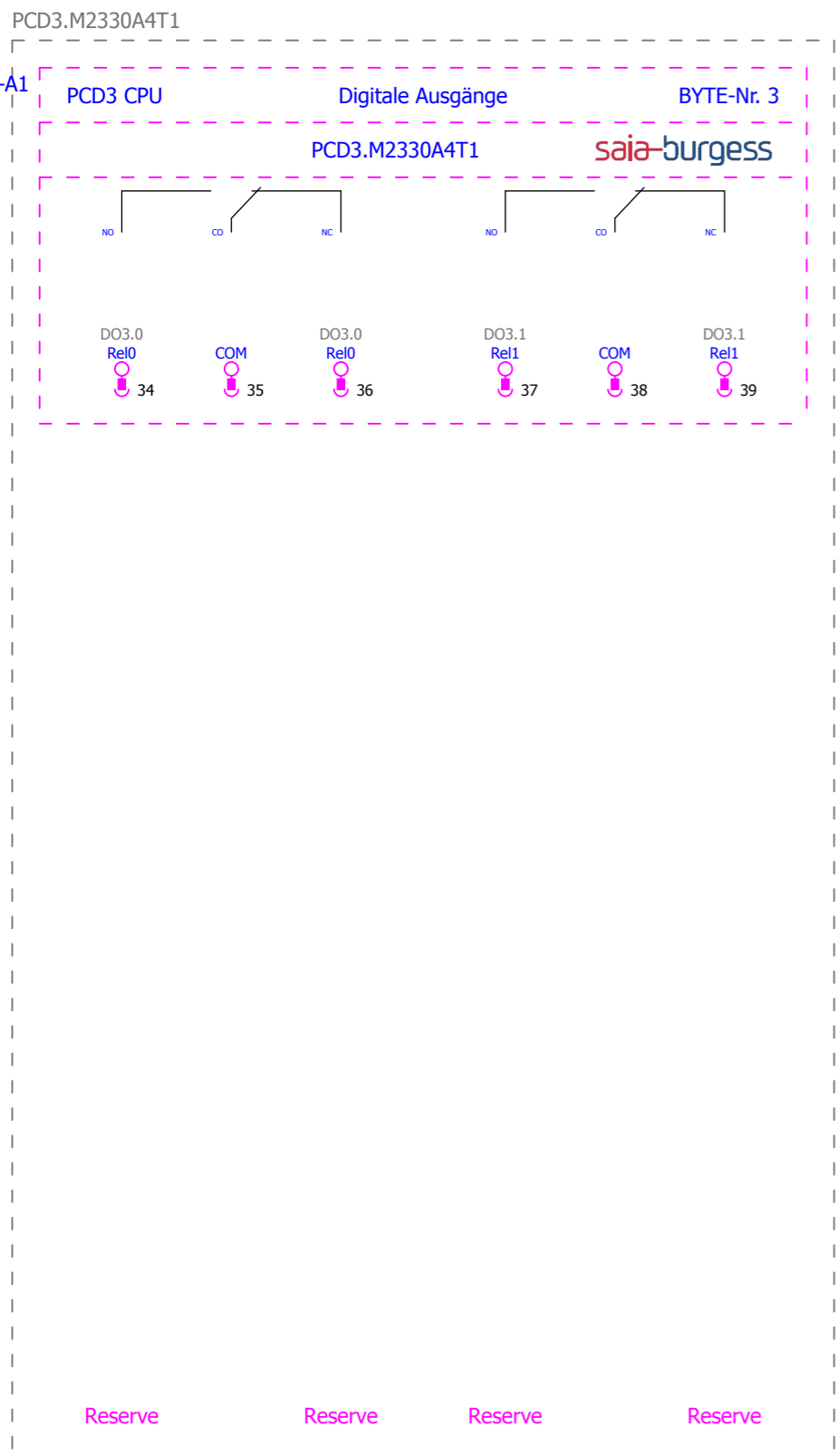

Saia-Burgess\PCD3 CPU\PCD3.M2330A4T1.ema
 Multi-line
 Variant D
 2012-10-26 / 2.1.4

			Datum	26.10.2012	EPLAN Software & Service Saia-Burgess Makroprojekt	Saia-Burgess Controls Ltd. <small>Control Systems and Components</small>	Allpolig	= PCD3 CPU		Blatt 4
			Bearb.	KAF				+ PCD3.M2330A4T1		
			Gepr							
Änderung	Datum	Name	Urspr		Ersatz von	Ersetzt durch			Blatt	522

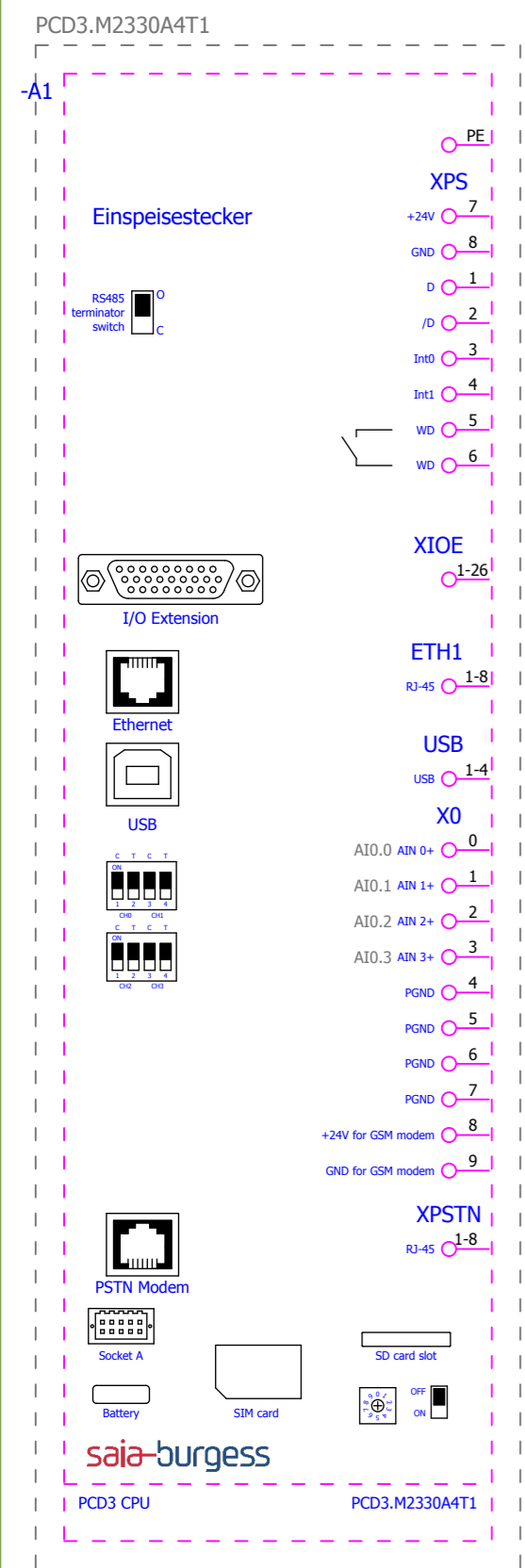

Reserve
Reserve
Reserve
Reserve

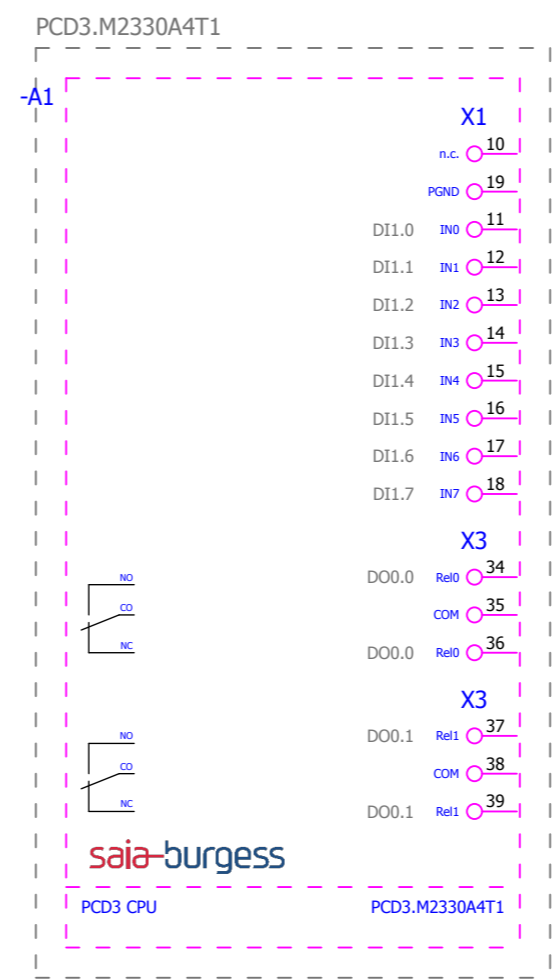

Reserve
Reserve
Reserve
Reserve
Reserve
Reserve
Reserve
Reserve
Reserve
Reserve
Reserve
Reserve
Reserve
Reserve
Reserve

Saia-Burgess\PCD3 CPU\PCD3.M2330A4T1.ema
Overview
Variant B
2012-10-26 / 2.1.4

Saia-Burgess\PCD3 CPU\PCD3.M2330A4T1.ema
Overview
Variant A
2012-10-26 / 2.1.4

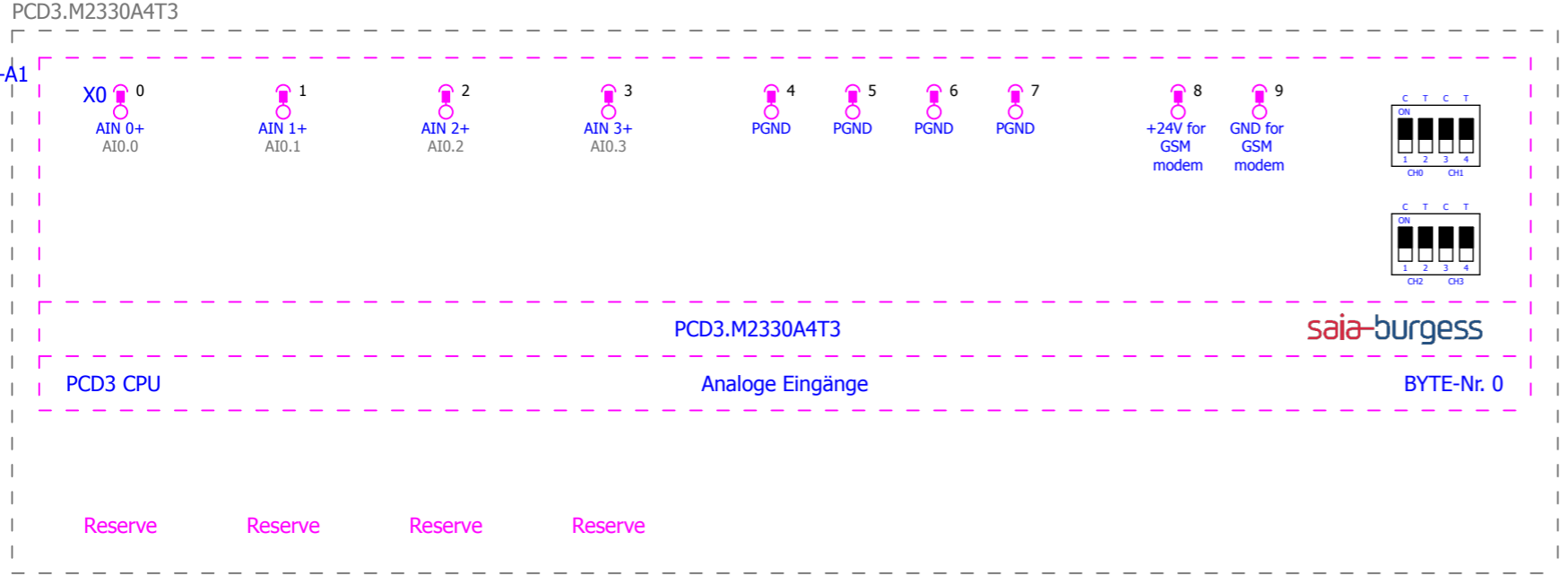

Saia-Burgess\PCD3 CPU\PCD3.M2330A4T3.ema
Multi-line
Variant B
2012-10-26 / 2.1.4

			Datum	26.10.2012	EPLAN Software & Service Saia-Burgess Makroprojekt	Saia-Burgess Controls Ltd. Control Systems and Components	Saia-Burgess Controls Ltd.	Allpolig	= PCD3 CPU	
			Bearb.	KAF					+ PCD3.M2330A4T3	
			Gepr						Blatt	2
Änderung	Datum	Name	Urspr	Ersatz von	Ersetzt durch				Blatt	522



Saia-Burgess\PCD3 CPU\PCD3.M2330A4T3.ema
Multi-line
Variant C
2012-10-26 / 2.1.4

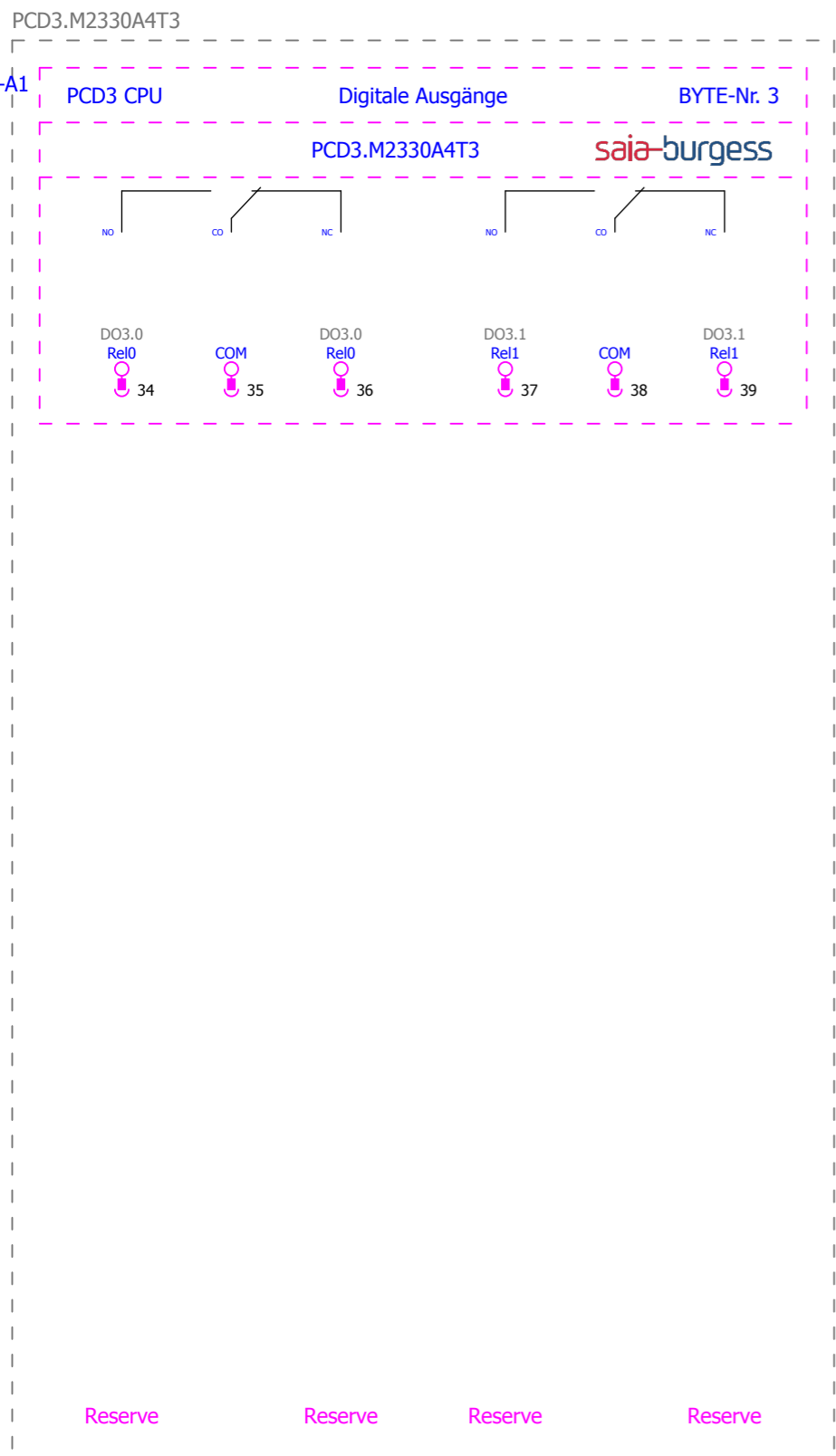

Saia-Burgess\PCD3 CPU\PCD3.M2330A4T3.ema
 Multi-line
 Variant D
 2012-10-26 / 2.1.4

			Datum	26.10.2012	EPLAN Software & Service Saia-Burgess Makroprojekt	Saia-Burgess Controls Ltd. <small>Control Systems and Components</small>	Allpolig	= PCD3 CPU		Blatt 4
			Bearb.	KAF				+ PCD3.M2330A4T3		
			Gepr							
Änderung	Datum	Name	Urspr		Ersatz von	Ersetzt durch			Blatt	522

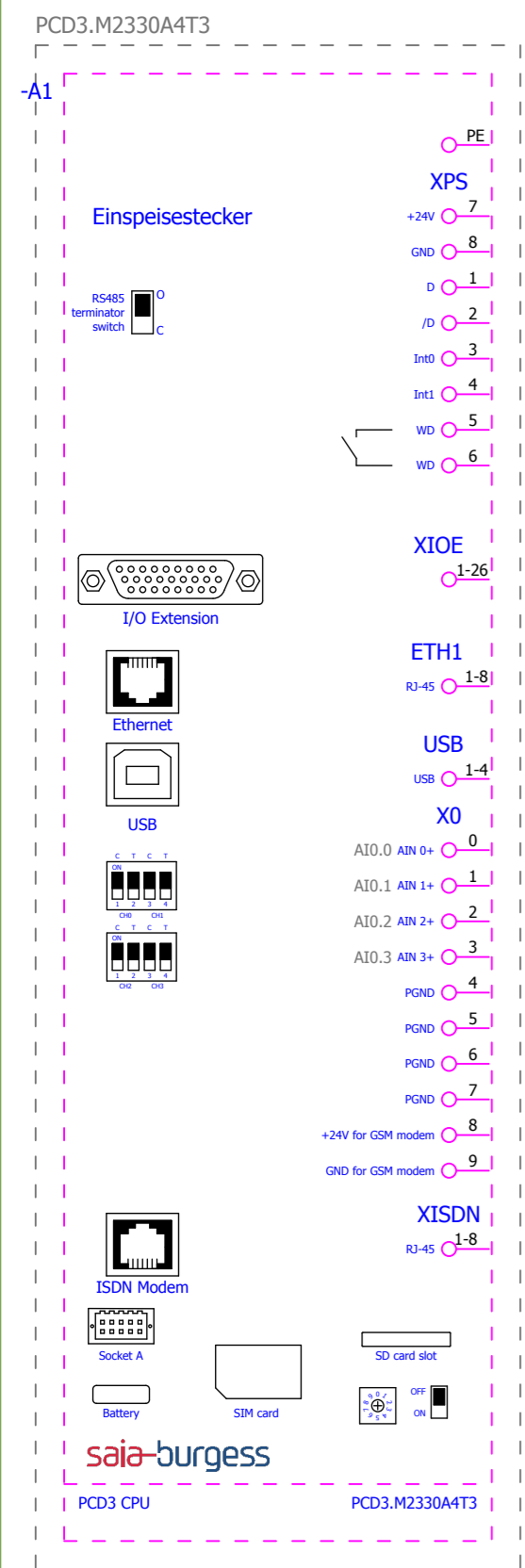

Reserve
Reserve
Reserve
Reserve

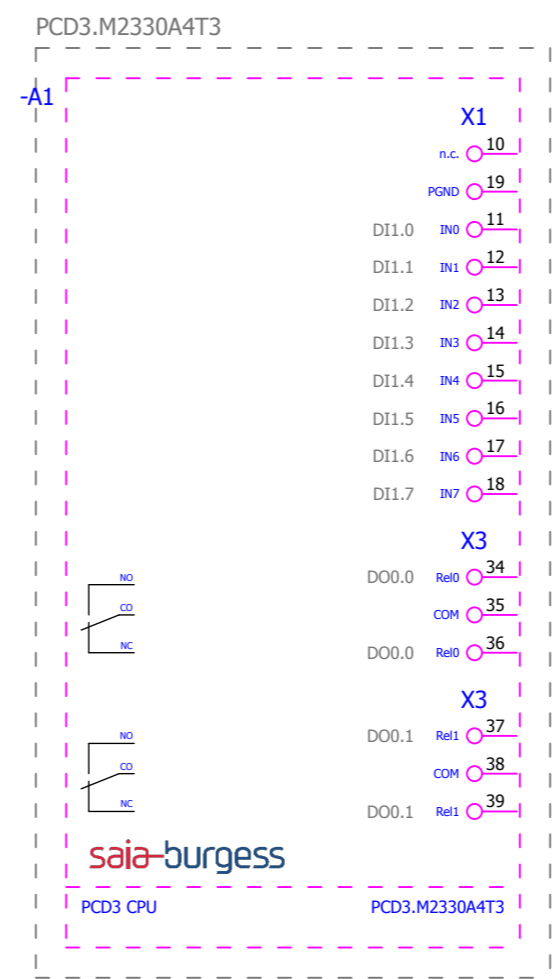

Reserve
Reserve
Reserve
Reserve
Reserve
Reserve
Reserve
Reserve
Reserve
Reserve
Reserve
Reserve
Reserve
Reserve
Reserve
Reserve

Saia-Burgess\PCD3 CPU\PCD3.M2330A4T3.ema
Overview
Variant B
2012-10-26 / 2.1.4

Saia-Burgess\PCD3 CPU\PCD3.M2330A4T3.ema
Overview
Variant A
2012-10-26 / 2.1.4

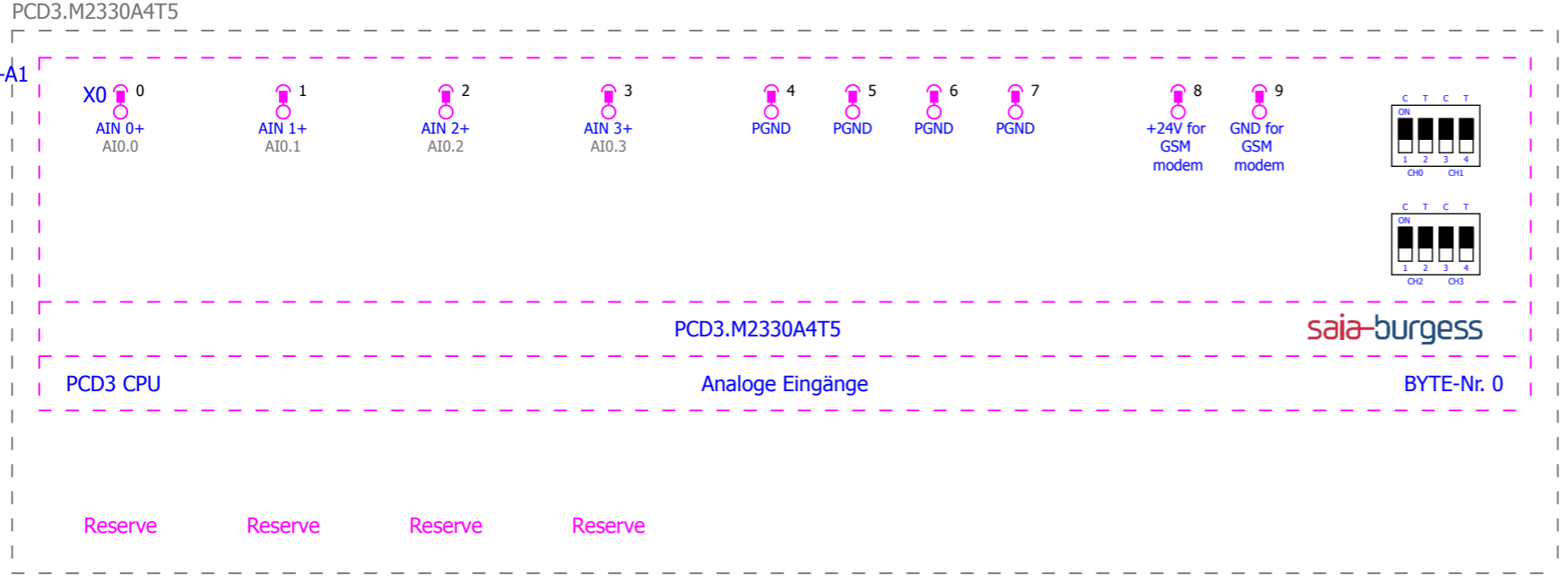

Saia-Burgess\PCD3 CPU\PCD3.M2330A4T5.ema
 Multi-line
 Variant B
 2012-10-26 / 2.1.4



Saia-Burgess\PCD3 CPU\PCD3.M2330A4T5.ema
 Multi-line
 Variant C
 2012-10-26 / 2.1.4

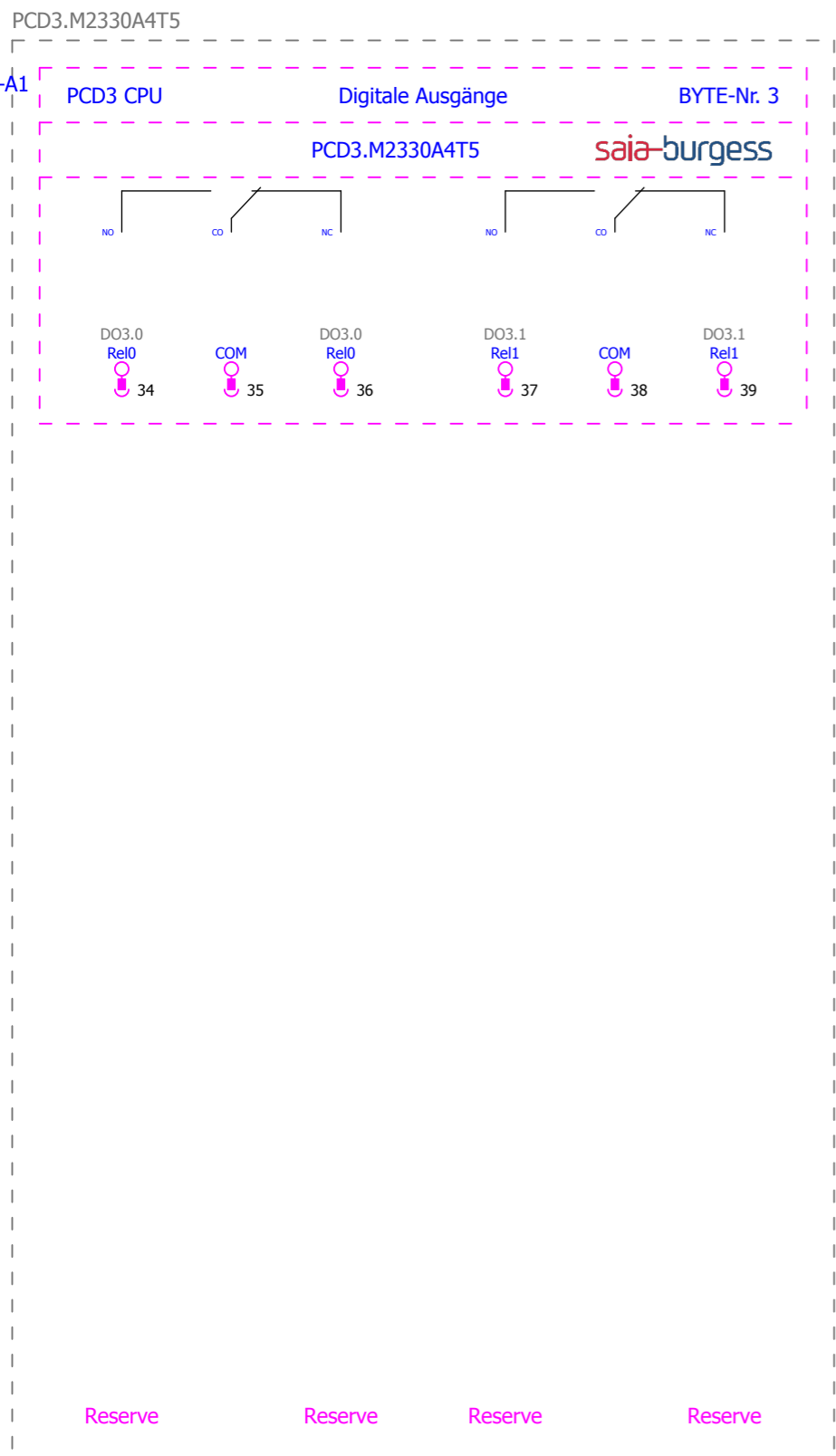

Saia-Burgess\PCD3 CPU\PCD3.M2330A4T5.ema
 Multi-line
 Variant D
 2012-10-26 / 2.1.4

			Datum	26.10.2012	EPLAN Software & Service Saia-Burgess Makroprojekt	Saia-Burgess Controls Ltd. Allpolig	= PCD3 CPU	
			Bearb.	KAF			+ PCD3.M2330A4T5	
			Gepr				Blatt	4
Änderung	Datum	Name	Urspr	Ersatz von	Ersetzt durch		Blatt	522

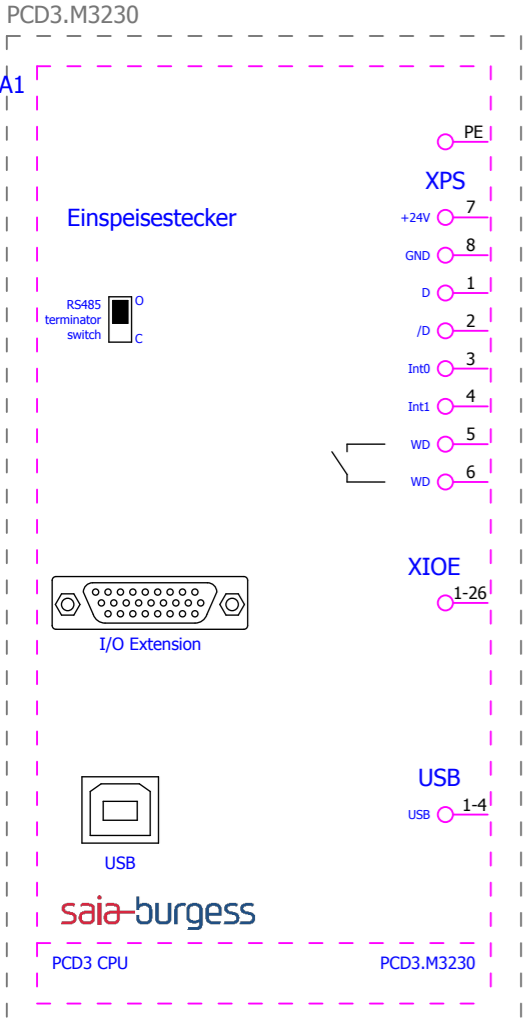

Saia-Burgess\PCD3 CPU\PCD3.M3230.ema
 Overview
 Variant A
 2012-10-26 / 2.1.4

			Datum	26.10.2012	EPLAN Software & Service Saia-Burgess Makroprojekt	Saia-Burgess Controls Ltd.	SPS-Übersicht			= PCD3 CPU
			Bearb.	KAF						+ PCD3.M3230
			Gepr							
Änderung	Datum	Name	Urspr		Ersatz von	Ersetzt durch			Blatt	10
									Blatt	522

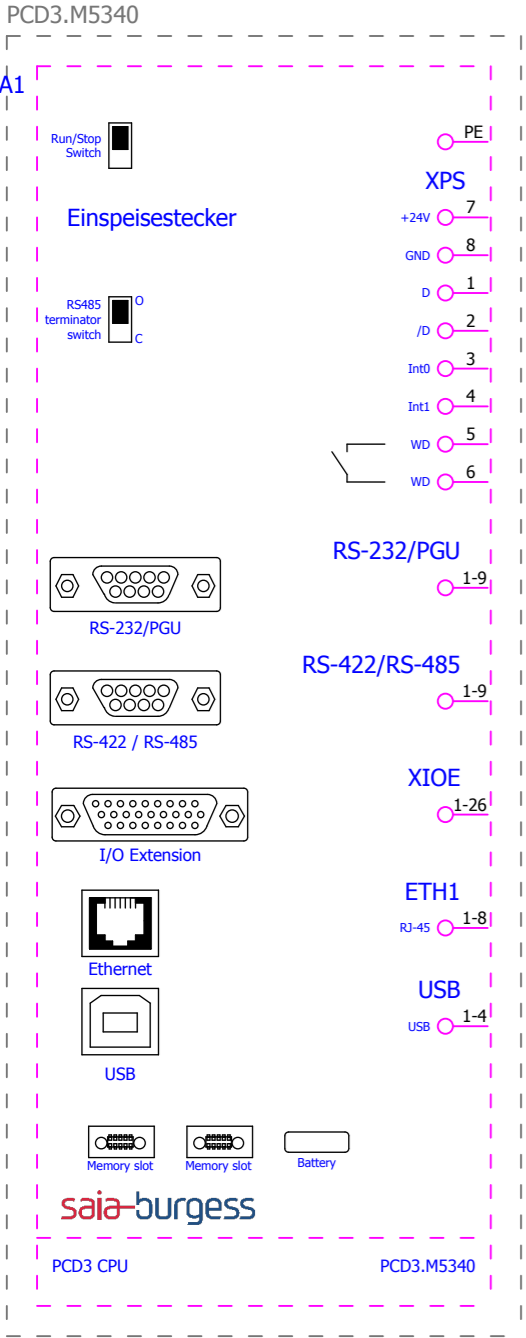

Saia-Burgess\PCD3 CPU\PCD3.M5340.ema
 Overview
 Variant A
 2012-10-26 / 2.1.4

			Datum	26.10.2012	EPLAN Software & Service Saia-Burgess Makroprojekt	Saia-Burgess Controls Ltd.	SPS-Übersicht		= PCD3 CPU	Blatt 10	
			Bearb.	KAF					+ PCD3.M5340		Blatt 522
			Gepr								
Änderung	Datum	Name	Urspr		Ersatz von	Ersetzt durch					

PCD3.M5440

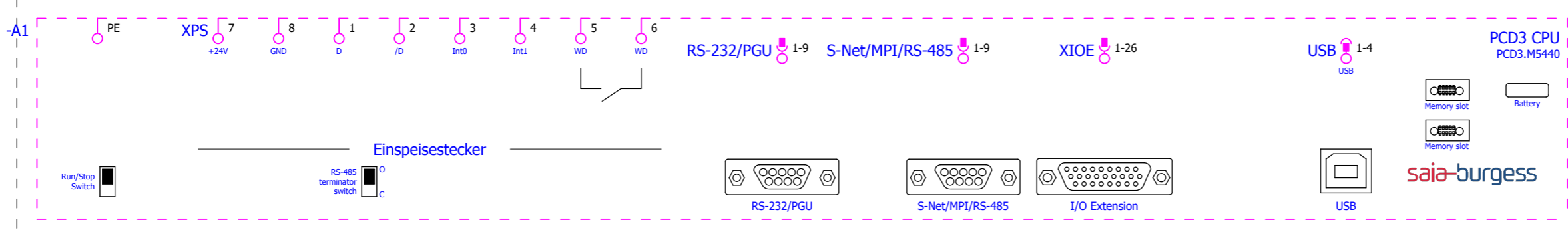

Saia-Burgess\PCD3 CPU\PCD3.M5440.ema
 Multi-line
 Variant A
 2012-10-26 / 2.1.4

			Datum	26.10.2012	EPLAN Software & Service Saia-Burgess Makroprojekt	Saia-Burgess Controls Ltd. Control Systems and Components	Saia-Burgess Controls Ltd.	Allpolig	= PCD3 CPU	
			Bearb.	KAF					+ PCD3.M5440	
			Gepr						Blatt	1
Änderung	Datum	Name	Urspr		Ersatz von	Ersetzt durch			Blatt	522

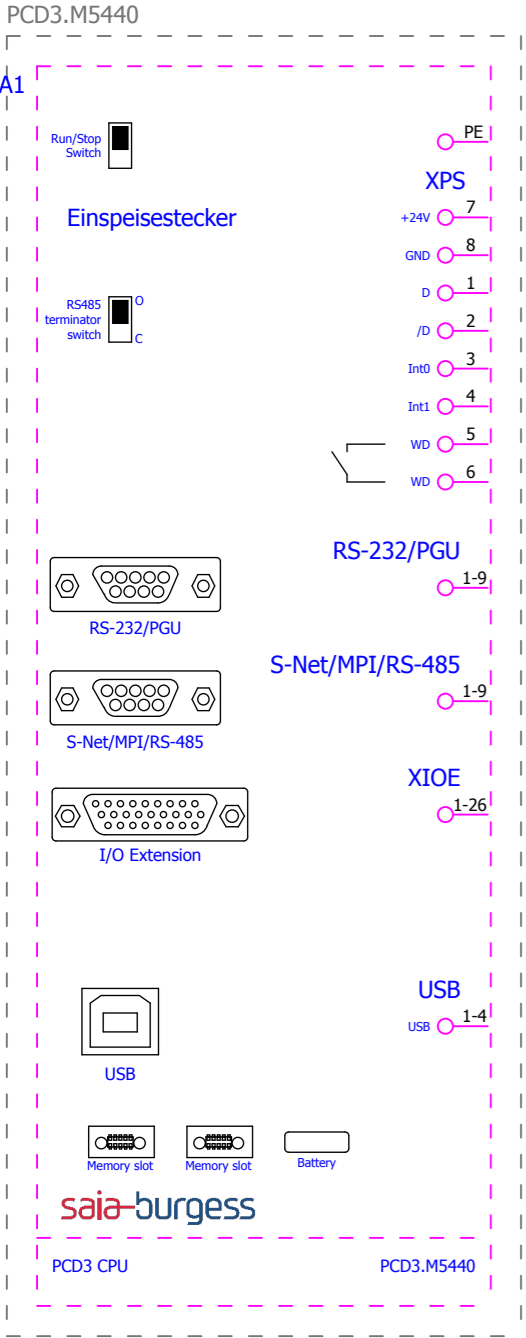

Saia-Burgess\PCD3 CPU\PCD3.M5440.ema
 Overview
 Variant A
 2012-10-26 / 2.1.4

			Datum	26.10.2012	EPLAN Software & Service Saia-Burgess Makroprojekt	Saia-Burgess Controls Ltd.	SPS-Übersicht		= PCD3 CPU	Blatt 10	
			Bearb.	KAF					+ PCD3.M5440		Blatt 522
			Gepr								
Änderung	Datum	Name	Urspr		Ersatz von	Ersetzt durch					

PCD3.M6240

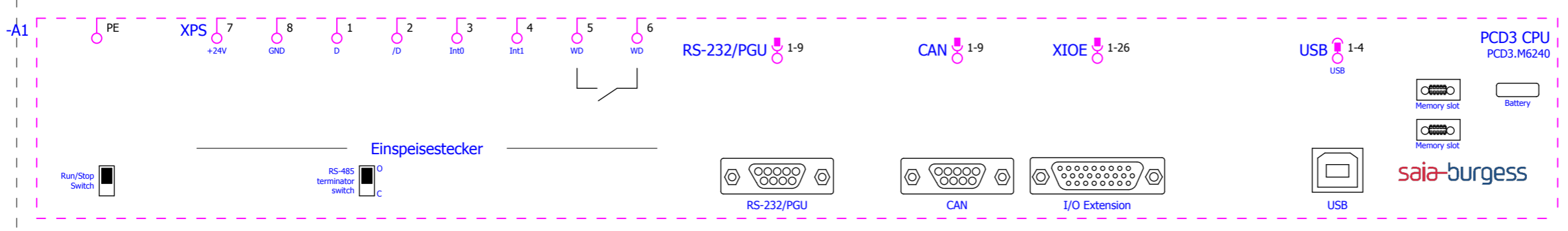

Saia-Burgess\PCD3 CPU\PCD3.M6240.ema
 Multi-line
 Variant A
 2012-10-26 / 2.1.4

			Datum	26.10.2012	EPLAN Software & Service Saia-Burgess Makroprojekt	Saia-Burgess Controls Ltd. Control Systems and Components	Saia-Burgess Controls Ltd.	Allpolig	= PCD3 CPU		Blatt 1	
			Bearb.	KAF					+ PCD3.M6240			Blatt 522
			Gepr									
Änderung	Datum	Name	Urspr		Ersatz von	Ersetzt durch						

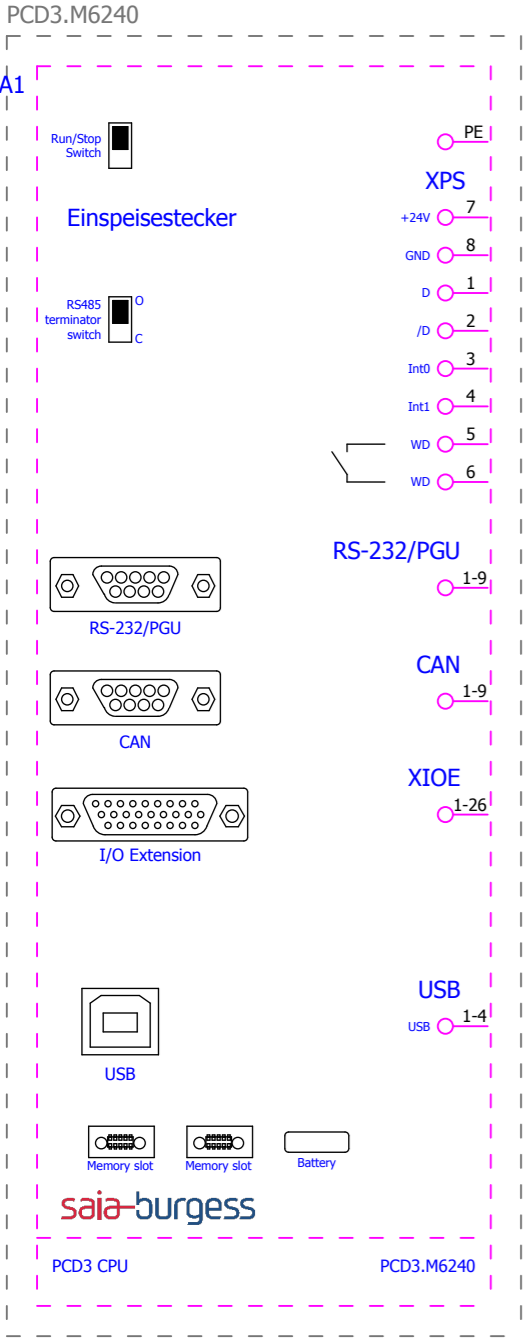

Saia-Burgess\PCD3 CPU\PCD3.M6240.ema
 Overview
 Variant A
 2012-10-26 / 2.1.4

			Datum	26.10.2012	EPLAN Software & Service Saia-Burgess Makroprojekt	Saia-Burgess Controls Ltd.	SPS-Übersicht	= PCD3 CPU		
			Bearb.	KAF				+ PCD3.M6240		
			Gepr							Blatt
Änderung	Datum	Name	Urspr		Ersatz von	Ersetzt durch			Blatt	522

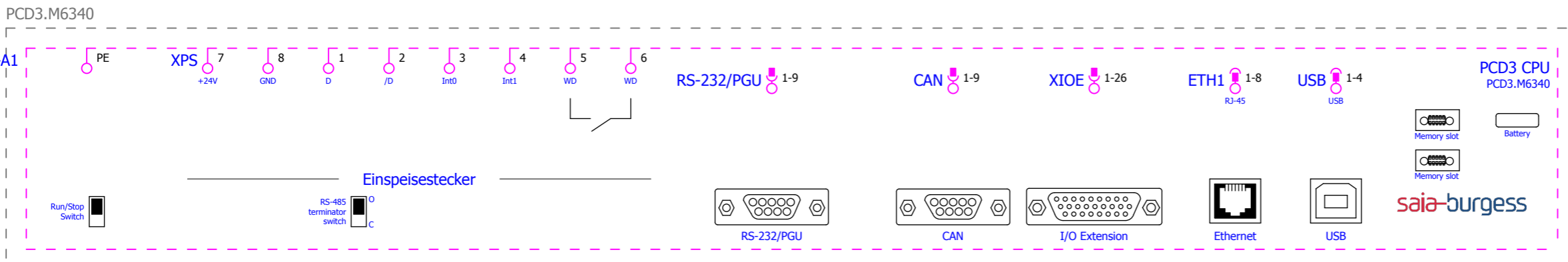

Saia-Burgess\PCD3 CPU\PCD3.M6340.ema
 Multi-line
 Variant A
 2012-10-26 / 2.1.4

			Datum	26.10.2012	EPLAN Software & Service Saia-Burgess Makroprojekt	Saia-Burgess Controls Ltd. <small>Control Systems and Components</small>	Saia-Burgess Controls Ltd.	Allpolig	= PCD3 CPU		Blatt 1	
			Bearb.	KAF					+ PCD3.M6340			Blatt 522
			Gepr									
Änderung	Datum	Name	Urspr		Ersatz von	Ersetzt durch						

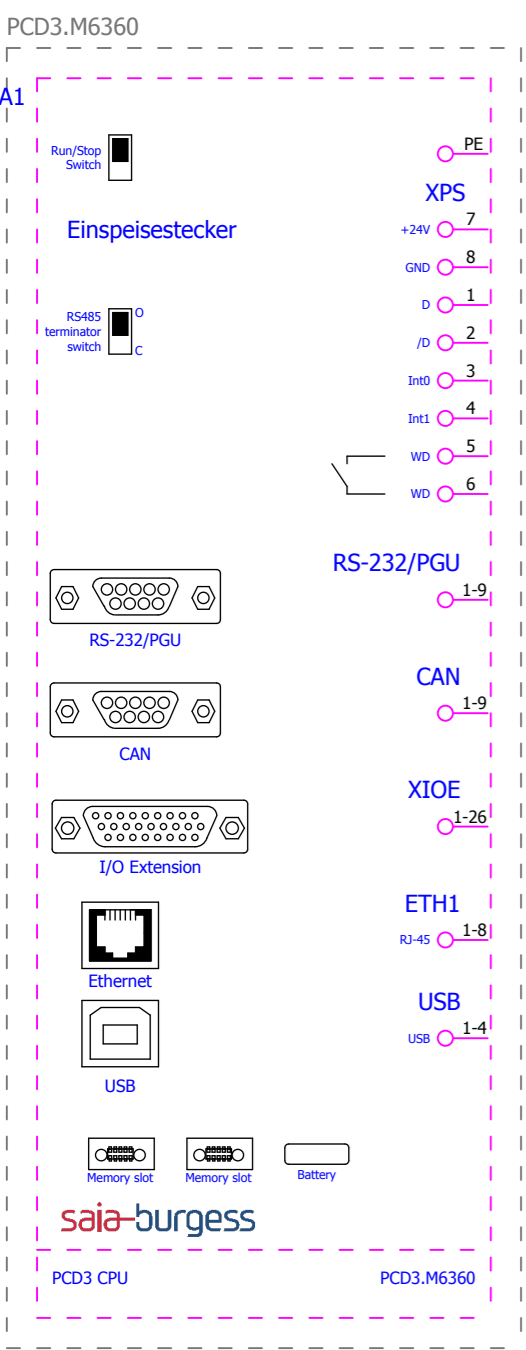

Saia-Burgess\PCD3 CPU\PCD3.M6360.ema
 Overview
 Variant A
 2012-10-26 / 2.1.4

			Datum	26.10.2012	EPLAN Software & Service Saia-Burgess Makroprojekt	Saia-Burgess Controls Ltd.	SPS-Übersicht			= PCD3 CPU
			Bearb.	KAF						+ PCD3.M6360
			Gepr							
Änderung	Datum	Name	Urspr		Ersatz von	Ersetzt durch			Blatt	10
									Blatt	522

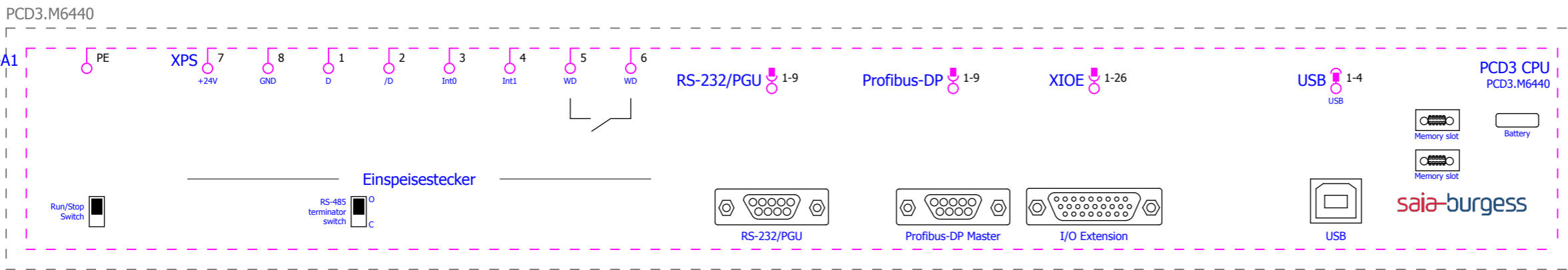

Saia-Burgess\PCD3 CPU\PCD3.M6440.ema
 Multi-line
 Variant A
 2012-10-26 / 2.1.4

			Datum	26.10.2012	EPLAN Software & Service Saia-Burgess Makroprojekt	Saia-Burgess Controls Ltd. <small>Control Systems and Components</small>	Allpolig	= PCD3 CPU	
			Bearb.	KAF				+ PCD3.M6440	
			Gepr					Blatt	1
Änderung	Datum	Name	Urspr		Ersatz von	Ersetzt durch		Blatt	522

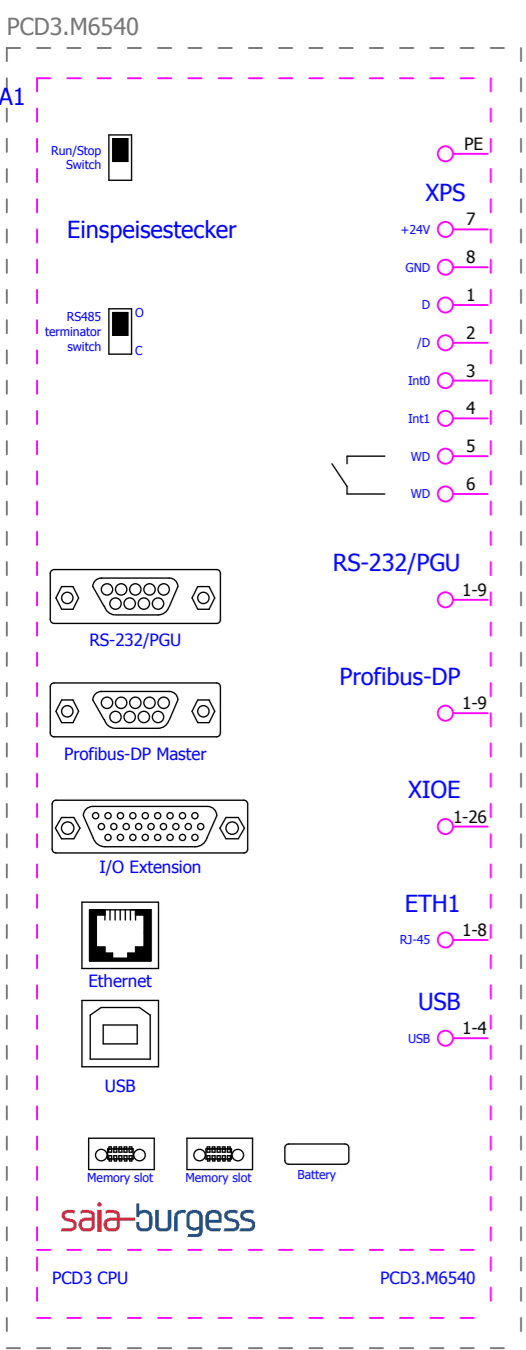

Saia-Burgess\PCD3 CPU\PCD3.M6540.ema
 Overview
 Variant A
 2012-10-26 / 2.1.4

			Datum	26.10.2012	EPLAN Software & Service Saia-Burgess Makroprojekt	Saia-Burgess Controls Ltd.	SPS-Übersicht			= PCD3 CPU
			Bearb.	KAF						+ PCD3.M6540
			Gepr							
Änderung	Datum	Name	Urspr		Ersatz von	Ersetzt durch			Blatt	10
									Blatt	522

PCD7.D410ET7F

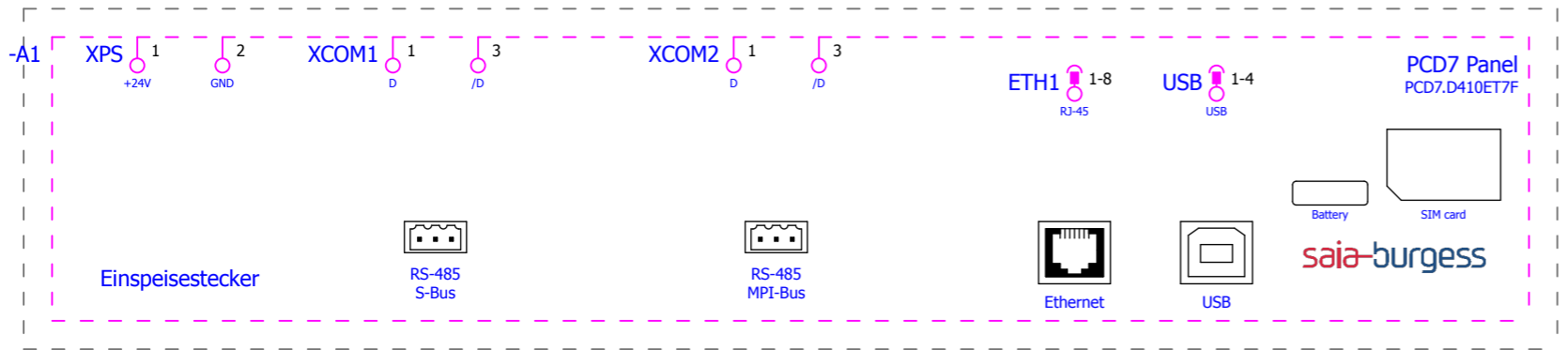

Saia-Burgess\PCD7 Panels\PCD7.D410ET7F.ema
 Multi-line
 Variant A
 2012-10-26 / 2.1.4

=PCD3 CPU+PCD3.M6560/10

			Datum	26.10.2012	EPLAN Software & Service Saia-Burgess Makroprojekt	Saia-Burgess Controls Ltd. Control Systems and Components	Saia-Burgess Controls Ltd.	Allpolig	= PCD7 Panels	
			Bearb.	KAF					+ PCD7.D410ET7F	
			Gepr						Blatt	1
Änderung	Datum	Name	Urspr		Ersatz von	Ersetzt durch			Blatt	522

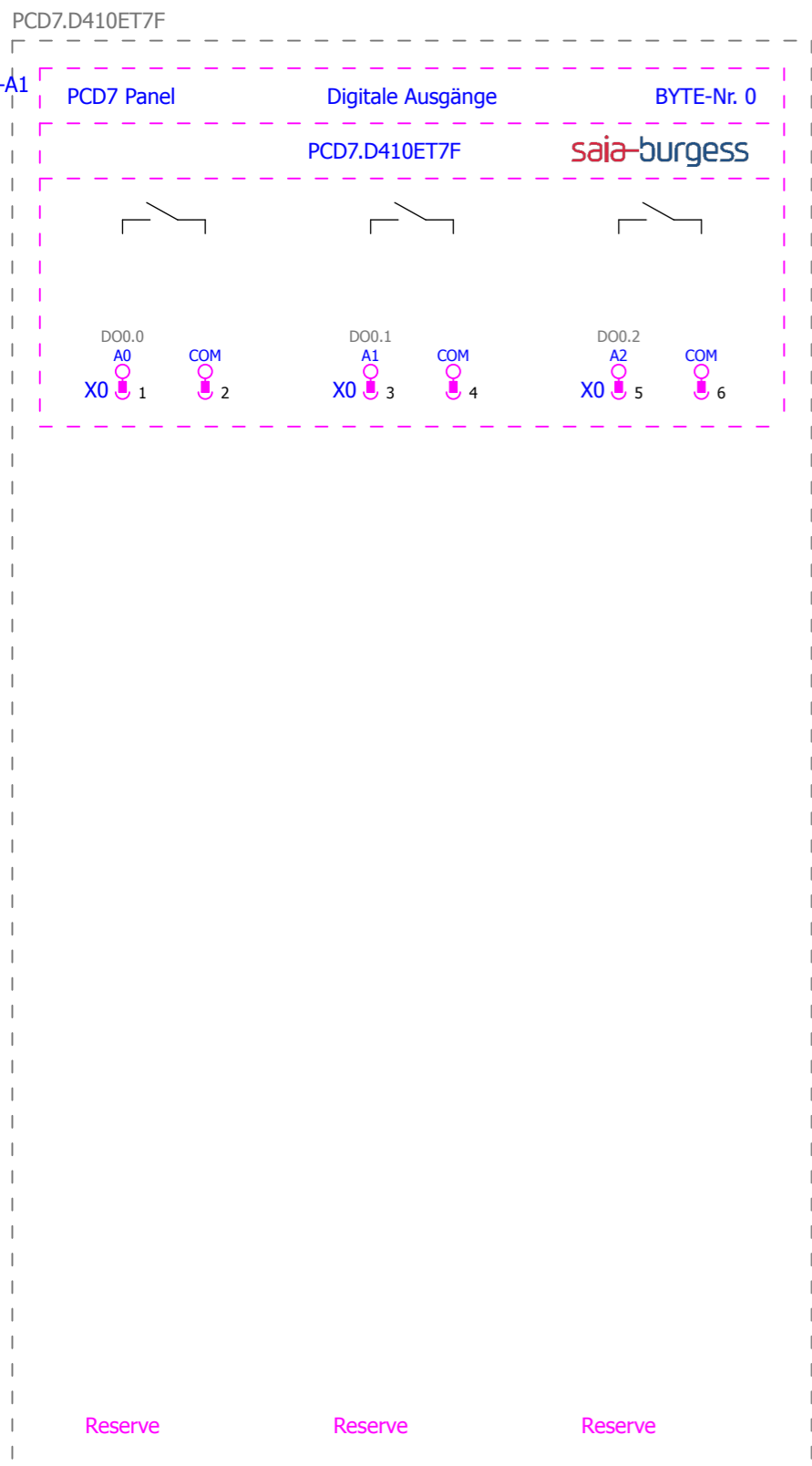

Saia-Burgess\PCD7 Panels\PCD7.D410ET7F.ema
 Multi-line
 Variant B
 2012-10-26 / 2.1.4

			Datum	26.10.2012	EPLAN Software & Service Saia-Burgess Makroprojekt	Saia-Burgess Controls Ltd.	Allpolig	= PCD7 Panels		Blatt 2
			Bearb.	KAF				+ PCD7.D410ET7F		
			Gepr							
Änderung	Datum	Name	Urspr		Ersatz von	Ersetzt durch			Blatt	522

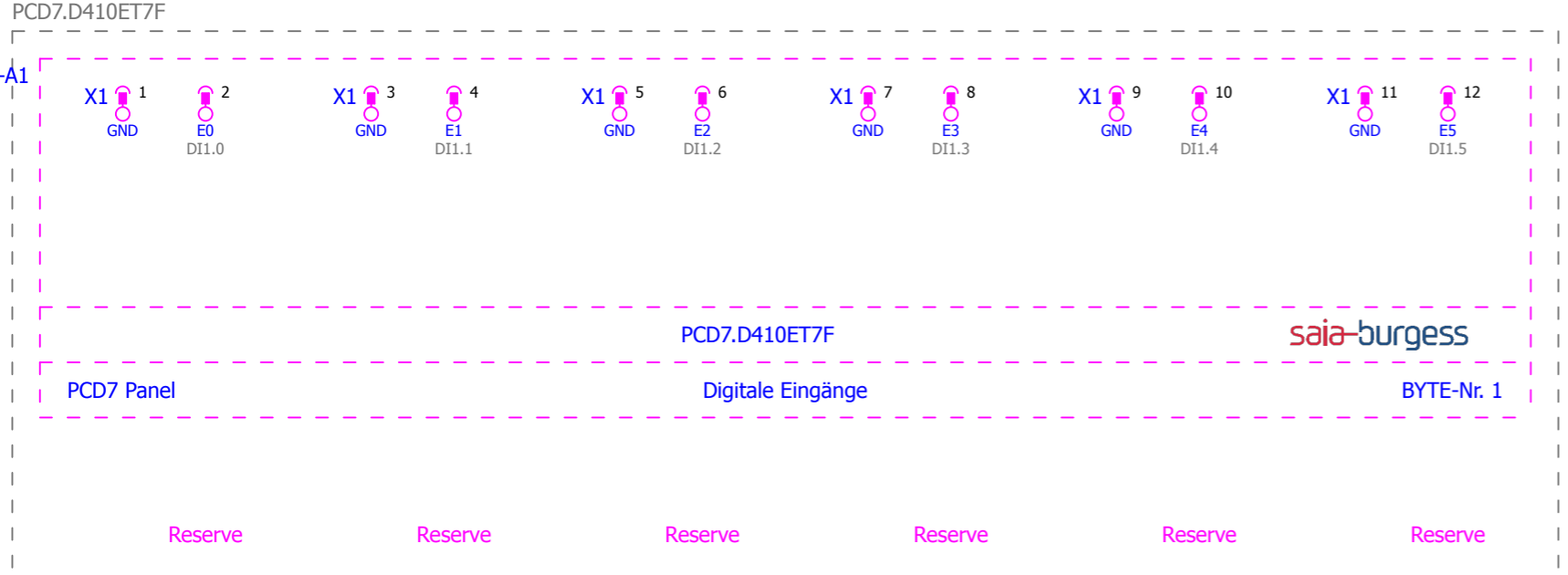

Saia-Burgess\PCD7 Panels\PCD7.D410ET7F.ema
 Multi-line
 Variant C
 2012-10-26 / 2.1.4

PCD7.D410VTCF

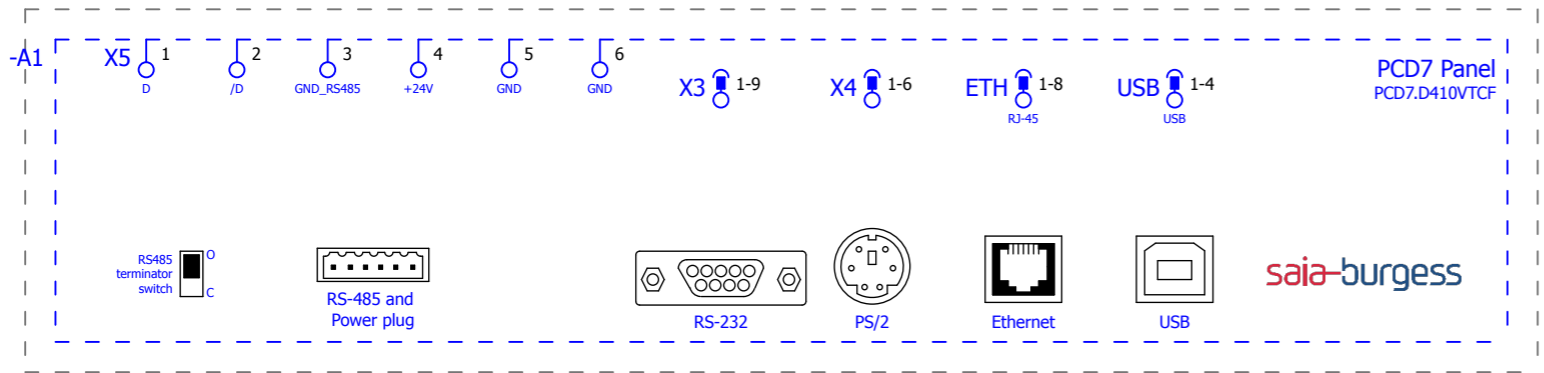

Saia-Burgess\PCD7 Panels\PCD7.D410VTCF.ema
 Multi-line
 Variant A
 2012-10-26 / 2.1.4

			Datum	26.10.2012	EPLAN Software & Service Saia-Burgess Makroprojekt	 Control Systems and Components	Saia-Burgess Controls Ltd.	Allpolig		= PCD7 Panels		
			Bearb.	KAF							+ PCD7.D410VTCF	
			Gepr									Blatt
Änderung	Datum	Name	Urspr		Ersatz von	Ersetzt durch					Blatt	522

PCD7.D457VTCFH

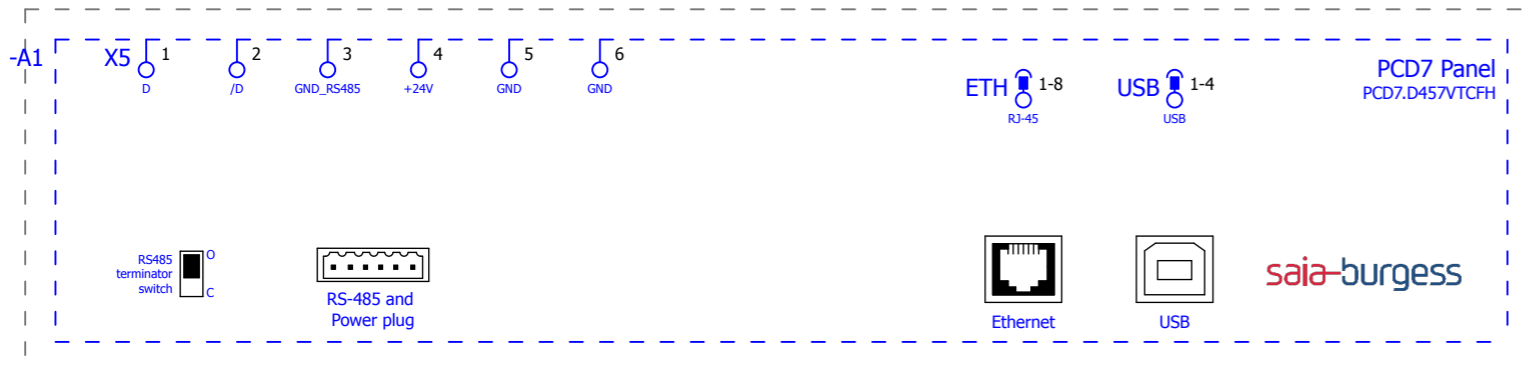

Saia-Burgess\PCD7 Panels\PCD7.D457VTCFH.ema
 Multi-line
 Variant A
 2012-10-26 / 2.1.4

			Datum	26.10.2012	EPLAN Software & Service Saia-Burgess Makroprojekt	 Control Systems and Components	Saia-Burgess Controls Ltd.		Allpolig		= PCD7 Panels	
			Bearb.	KAF							+ PCD7.D457VTCFH	
			Gepr									
Änderung	Datum	Name	Urspr		Ersatz von	Ersetzt durch					Blatt	1
											Blatt	522

PCD7.D457ET7F

A1 PCD7 Panel Digitale Ausgänge BYTE-Nr. 0

PCD7.D457ET7F saia-burgess

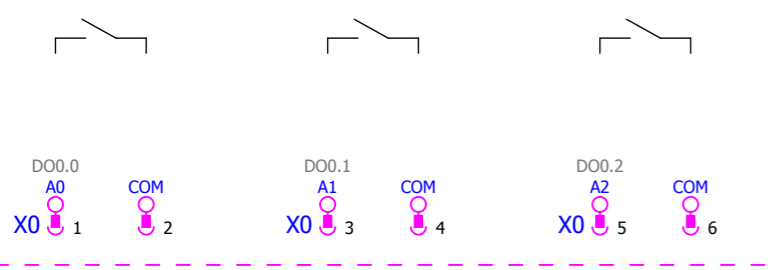

Reserve Reserve Reserve

Saia-Burgess\PCD7 Panels\PCD7.D457ET7F.ema
Multi-line
Variant B
2012-10-26 / 2.1.4

			Datum	26.10.2012	EPLAN Software & Service Saia-Burgess Makroprojekt	Saia-Burgess Controls Ltd.	Allpolig	= PCD7 Panels		Blatt 2
			Bearb.	KAF				+ PCD7.D457ET7F		
			Gepr							
Änderung	Datum	Name	Urspr		Ersatz von	Ersetzt durch			Blatt	522

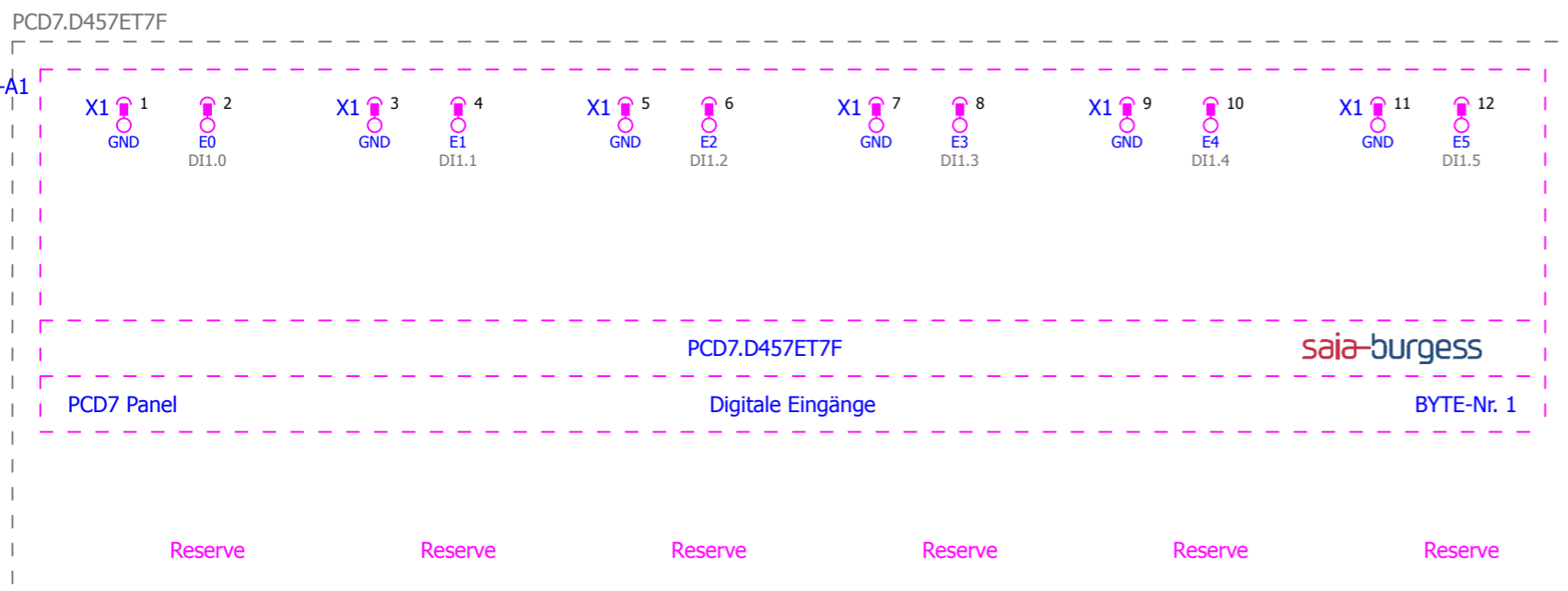

Saia-Burgess\PCD7 Panels\PCD7.D457ET7F.ema
 Multi-line
 Variant C
 2012-10-26 / 2.1.4

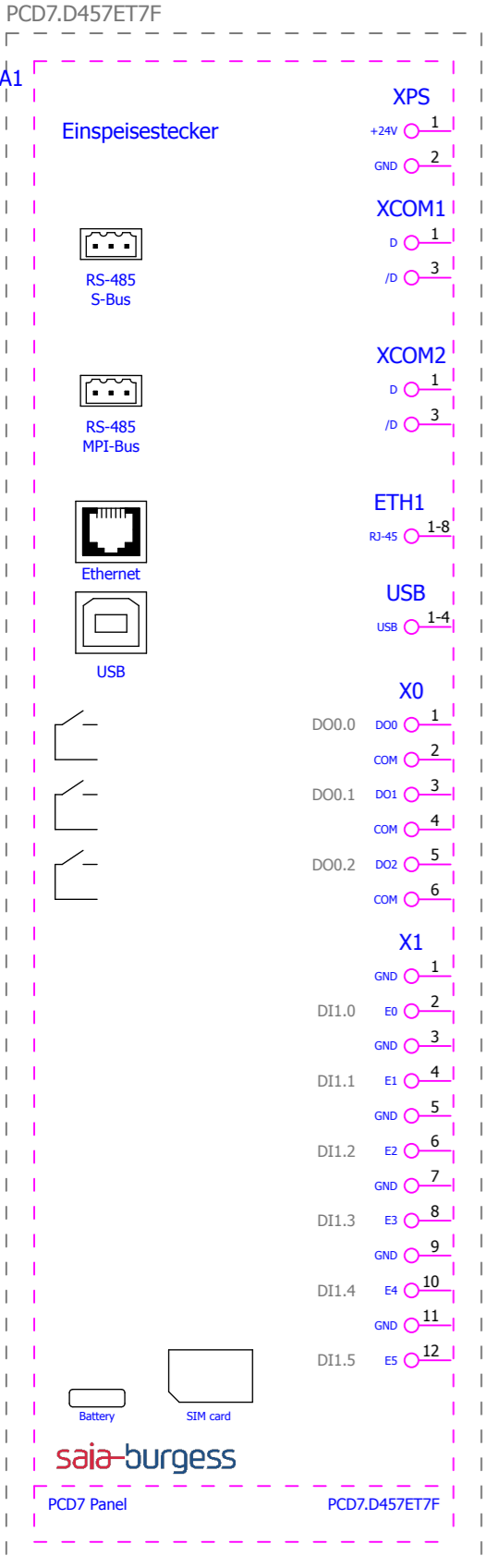

Reserve

Reserve

Reserve

Reserve

Reserve

Reserve

Reserve

Reserve

Reserve

Reserve

Reserve

Reserve

Saia-Burgess\PCD7 Panels\PCD7.D457ET7F.ema
 Overview
 Variant A
 2012-10-26 / 2.1.4

=PCD7+.F110S/1

			Datum	26.10.2012	EPLAN Software & Service Saia-Burgess Makroprojekt	Saia-Burgess Controls Ltd. Control Systems and Components	Saia-Burgess Controls Ltd.	SPS-Übersicht	= PCD7 Panels		Blatt 10
		Bearb.	KAF	+ PCD7.D457ET7F							
		Gepr									
Änderung	Datum	Name	Urspr	Ersatz von	Ersetzt durch					Blatt 522	

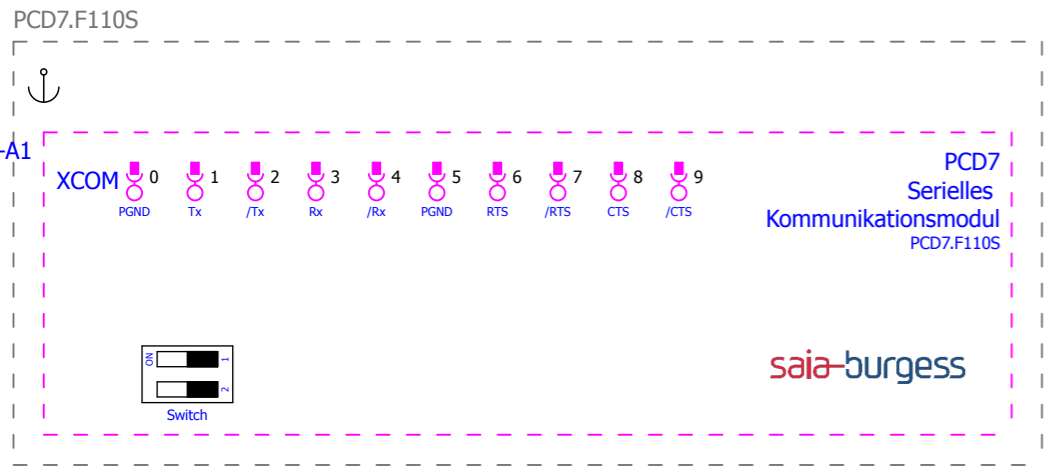

Saia-Burgess\PCD7\PCD7.F110S.ema
 Multi-line
 Variant A
 2012-10-26 / 2.1.4

			Datum	26.10.2012	EPLAN Software & Service Saia-Burgess Makroprojekt	 Control Systems and Components	Saia-Burgess Controls Ltd.	Allpolig	= PCD7	
		Bearb.	KAF	+ PCD7.F110S						
		Gepr							Blatt 1	
Änderung	Datum	Name	Urspr		Ersatz von	Ersetzt durch			Blatt 522	

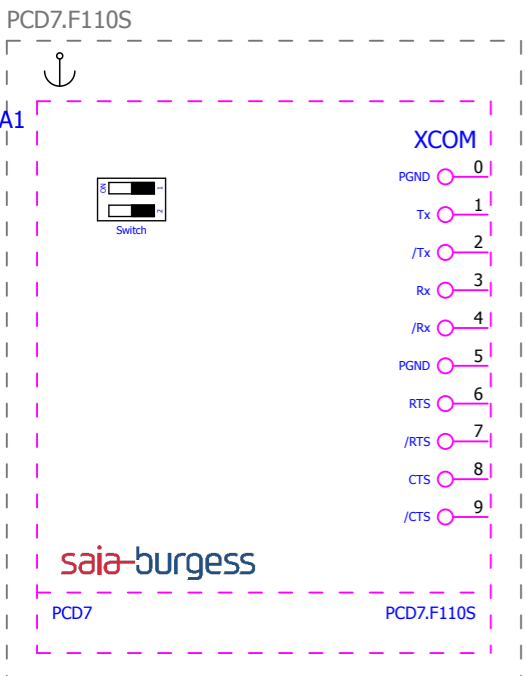

Saia-Burgess\PCD7\PCD7.F110S.ema
 Overview
 Variant A
 2012-10-26 / 2.1.4

			Datum	26.10.2012	EPLAN Software & Service Saia-Burgess Makroprojekt	Saia-Burgess Controls Ltd. <small>Control Systems and Components</small>	Saia-Burgess Controls Ltd.	SPS-Übersicht	= PCD7		Blatt 10
		Bearb.	KAF	+ PCD7.F110S							
		Gepr									
Änderung	Datum	Name	Üspr		Ersatz von	Ersetzt durch				Blatt	522

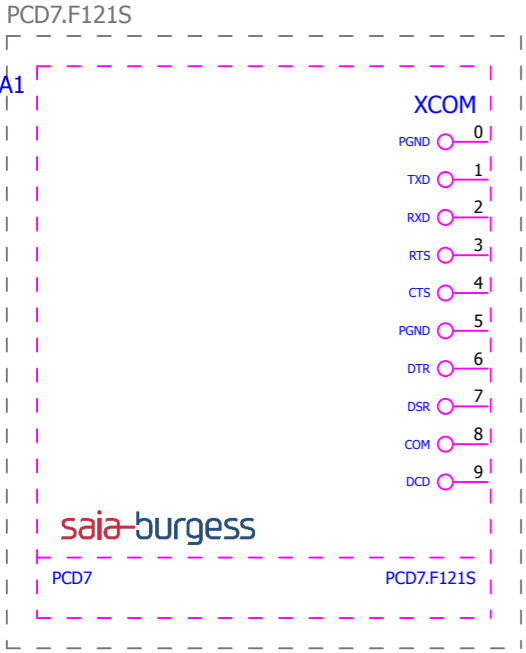

Saia-Burgess\PCD7\PCD7.F121S.ema
 Overview
 Variant A
 2012-10-26 / 2.1.4

			Datum	26.10.2012	EPLAN Software & Service Saia-Burgess Makroprojekt	Saia-Burgess Controls Ltd. Control Systems and Components	Saia-Burgess Controls Ltd.	SPS-Übersicht	= PCD7		Blatt 10	
			Bearb.	KAF					+ PCD7.F121S			Blatt 522
			Gepr									
Änderung	Datum	Name	Urspr		Ersatz von	Ersetzt durch						

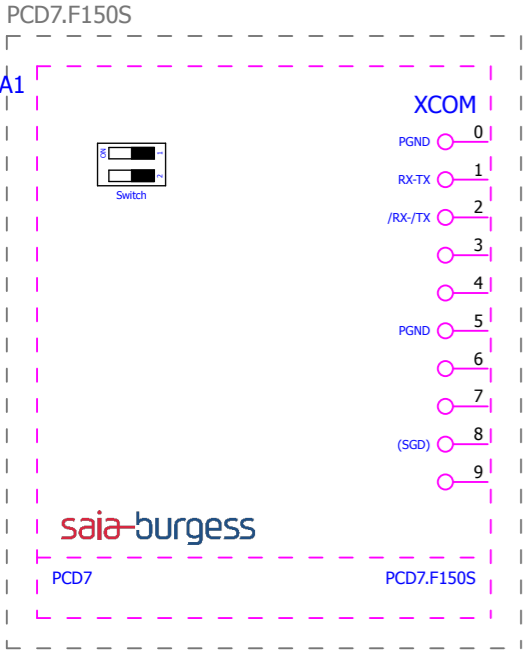

Saia-Burgess\PCD7\PCD7.F150S.ema
 Overview
 Variant A
 2012-10-26 / 2.1.4

			Datum	26.10.2012	EPLAN Software & Service Saia-Burgess Makroprojekt	Saia-Burgess Controls Ltd. Control Systems and Components	Saia-Burgess Controls Ltd.	SPS-Übersicht	= PCD7		Blatt 10
		Bearb.	KAF	+ PCD7.F150S							
		Gepr									
Änderung	Datum	Name	Üspr		Ersatz von	Ersetzt durch				Blatt	522

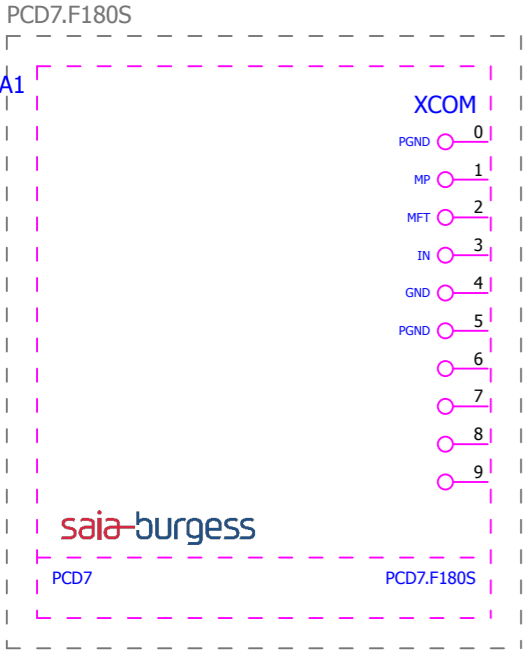

Saia-Burgess\PCD7\PCD7.F180S.ema
 Overview
 Variant A
 2012-10-26 / 2.1.4

			Datum	26.10.2012	EPLAN Software & Service Saia-Burgess Makroprojekt	Saia-Burgess Controls Ltd. Control Systems and Components	Saia-Burgess Controls Ltd.	SPS-Übersicht	= PCD7		Blatt 10
		Bearb.	KAF	+ PCD7.F180S							
		Gepr									
Änderung	Datum	Name	Urspr		Ersatz von	Ersetzt durch				Blatt 522	

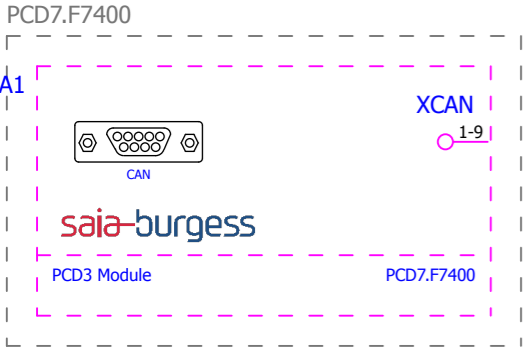

Saia-Burgess\PCD7\PCD7.F7400.ema
 Overview
 Variant A
 2012-10-26 / 2.1.4

			Datum	26.10.2012	 EPLAN Software & Service  Saia-Burgess Makroprojekt	 Control Systems and Components	Saia-Burgess Controls Ltd.	SPS-Übersicht	= PCD7		Blatt 10
		Bearb.	KAF	+ PCD7.F7400					Blatt 522		
		Gepr									
Änderung	Datum	Name	Urspr		Ersatz von	Ersetzt durch					

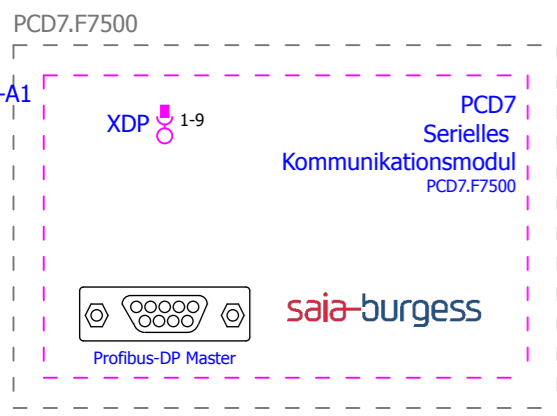

Saia-Burgess\PCD7\PCD7.F7500.ema
 Multi-line
 Variant A
 2012-10-26 / 2.1.4

			Datum	26.10.2012	EPLAN Software & Service Saia-Burgess Makroprojekt	Saia-Burgess Controls Ltd. Control Systems and Components	Saia-Burgess Controls Ltd.	Allpolig			= PCD7		
			Bearb.	KAF									+ PCD7.F7500
			Gepr										
Änderung	Datum	Name	Urspr		Ersatz von	Ersetzt durch				Blatt	1		
									Blatt	522			

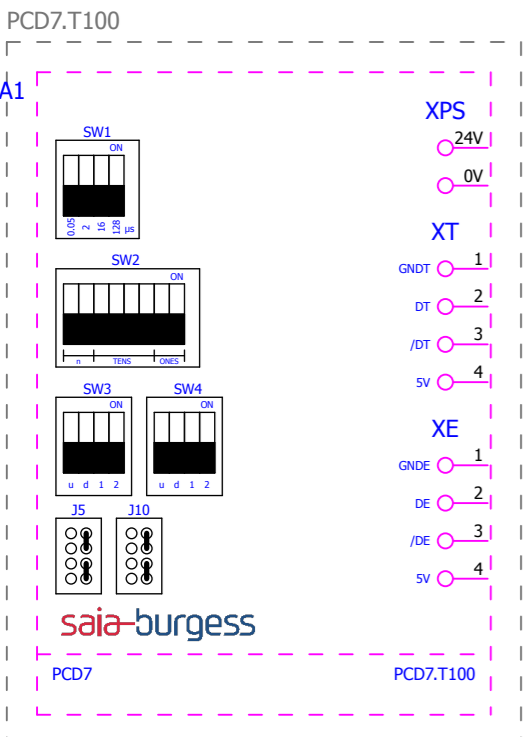

Saia-Burgess\PCD7\PCD7.T100.ema
 Overview
 Variant A
 2012-10-26 / 2.1.4

			Datum	26.10.2012	EPLAN Software & Service Saia-Burgess Makroprojekt	Saia-Burgess Controls Ltd. Control Systems and Components	Saia-Burgess Controls Ltd.	SPS-Übersicht	= PCD7		Blatt 10
		Bearb.	KAF	+ PCD7.T100							
		Gepr									
Änderung	Datum	Name	Urspr		Ersatz von	Ersetzt durch				Blatt 522	

Q.PS-AD1-2405

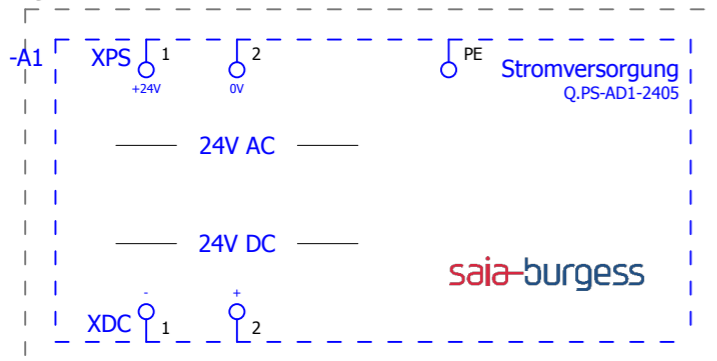

Saia-Burgess\Cabinet components\Q.PS-AD1-2405.ema
 Multi-line
 Variant A
 2012-10-26 / 2.1.4

+ .PS-AD1-2403/1

+ .PS-AD1-2407/1

			Datum	26.10.2012	EPLAN Software & Service Saia-Burgess Makroprojekt <small>Control Systems and Components</small>	Saia-Burgess Controls Ltd.	Allpolig	= Cabinet components	
			Bearb.	KAF				+ Q.PS-AD1-2405	
			Gepr					Blatt	1
Änderung	Datum	Name	Urspr		Ersatz von	Ersetzt durch		Blatt	522

Q.PS-AD1-2407

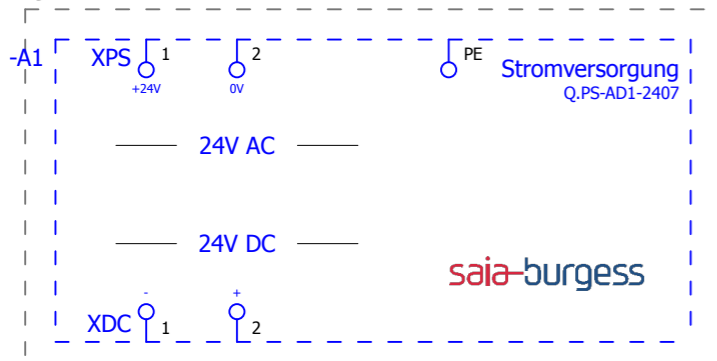

Saia-Burgess\Cabinet components\Q.PS-AD1-2407.ema
 Multi-line
 Variant A
 2012-10-26 / 2.1.4

+ .PS-AD1-2405/1

+ .PS-AD2-2402F/1

			Datum	26.10.2012	EPLAN Software & Service Saia-Burgess Makroprojekt	Saia-Burgess Controls Ltd. <small>Control Systems and Components</small>	Allpolig	= Cabinet components		Blatt 1
			Bearb.	KAF				+ Q.PS-AD1-2407		
			Gepr							
Änderung	Datum	Name	Urspr		Ersatz von	Ersetzt durch			Blatt	522

Q.PS-AD2-2402F

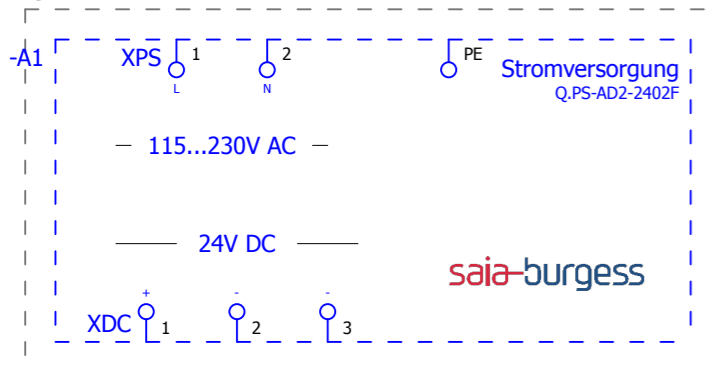

Saia-Burgess\Cabinet components\Q.PS-AD2-2402F.ema
 Multi-line
 Variant A
 2012-10-26 / 2.1.4

+ .PS-AD1-2407/1

+ .PS-AD2-2405F/1

			Datum	26.10.2012	 EPLAN Software & Service  Saia-Burgess Makroprojekt	 Saia-Burgess Controls Ltd. <small>Control Systems and Components</small>	Allpolig			= Cabinet components		Blatt 1	
		Bearb.	KAF	+ Q.PS-AD2-2402F									Blatt 522
		Gepr											
Änderung	Datum	Name	Urspr	Ersatz von	Ersetzt durch								

Q.PS-AD2-2405F

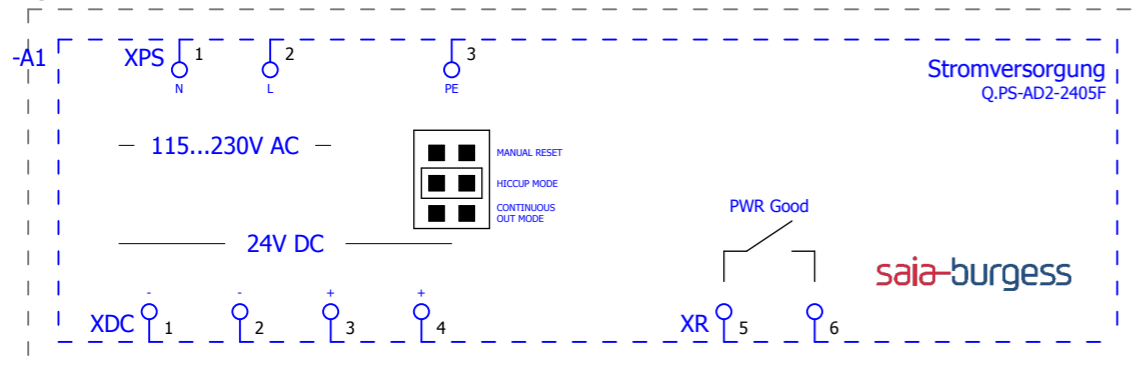

Saia-Burgess\Cabinet components\Q.PS-AD2-2405F.ema
 Multi-line
 Variant A
 2012-10-26 / 2.1.4

			Datum	26.10.2012	EPLAN Software & Service Saia-Burgess Makroprojekt	Saia-Burgess Controls Ltd. Control Systems and Components	Saia-Burgess Controls Ltd.	Allpolig	= Cabinet components		Blatt 1	
			Bearb.	KAF					+ Q.PS-AD2-2405F			Blatt 522
			Gepr									
Änderung	Datum	Name	Urspr		Ersatz von	Ersetzt durch			Blatt	1		

Q.PS-AD2-2410F

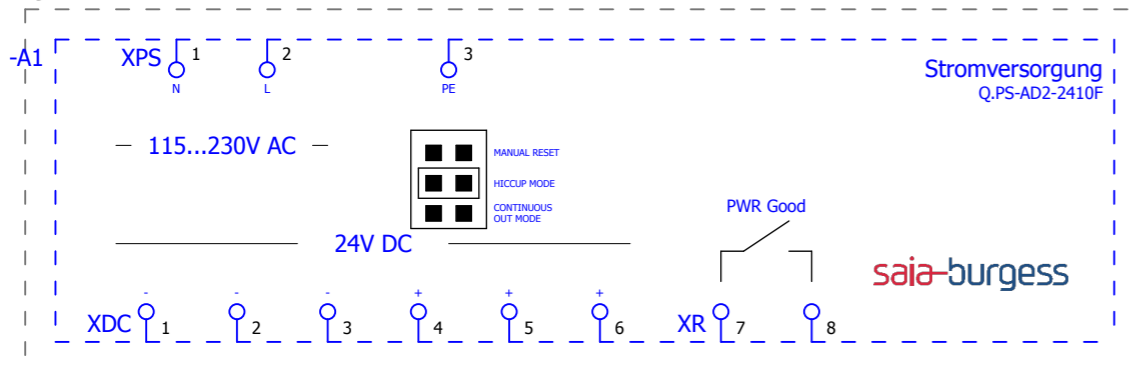

Saia-Burgess\Cabinet components\Q.PS-AD2-2410F.ema
 Multi-line
 Variant A
 2012-10-26 / 2.1.4

		Datum 26.10.2012		EPLAN Software & Service Saia-Burgess Makroprojekt	Saia-Burgess Controls Ltd. Control Systems and Components	Allpolig		= Cabinet components	
		Bearb. KAF						+ Q.PS-AD2-2410F	
		Gepr							
Änderung	Datum	Name	Urspr	Ersatz von	Ersetzt durch			Blatt	1
								Blatt	522

ALE3D5F11KCxA00

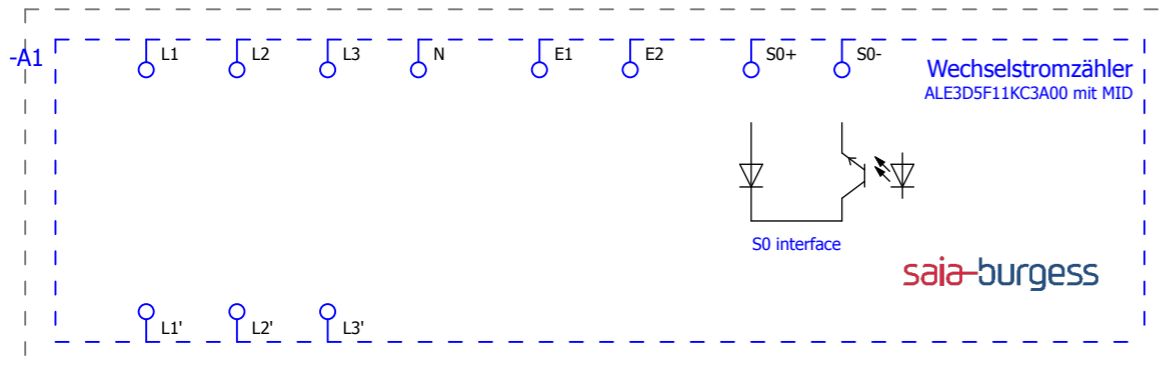

Saia-Burgess\Energy meter\ALE3D5F11KCxA00.ema
 Multi-line
 Variant A
 2012-10-26 / 2.1.4

+ALE3D5F10KBxA00/1

+ALE3D5FM10CxA00/1

			Datum	26.10.2012	EPLAN Software & Service Saia-Burgess Makroprojekt	Saia-Burgess Controls Ltd. <small>Control Systems and Components</small>	Allpolig			= Energy meter		
			Bearb.	KAF						+ ALE3D5F11KCxA00	Blatt	1
			Gepr								Blatt	522
Änderung	Datum	Name	Urspr		Ersatz von	Ersetzt durch						

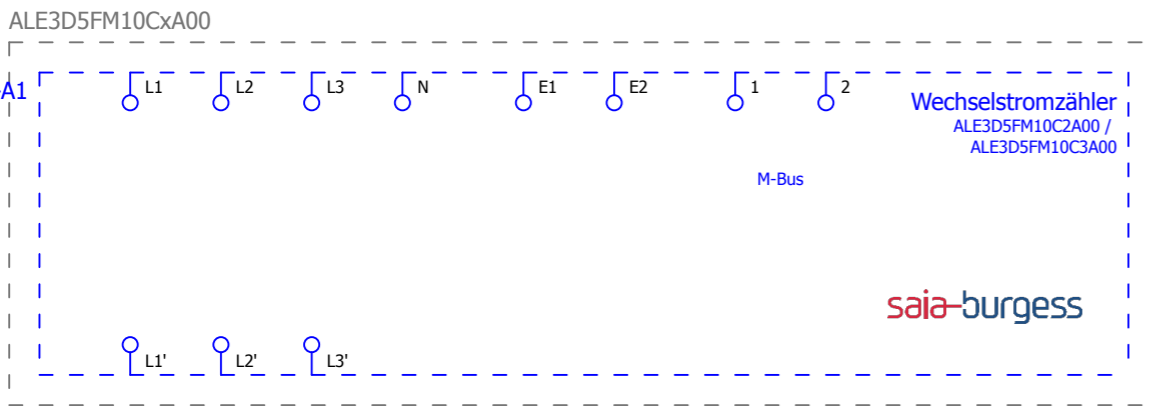

Saia-Burgess\Energy meter\ALE3D5FM10Cx A00.ema
Multi-line
Variant A
2012-10-26 / 2.1.4

+ALE3D5F11KCxA00/1 +ALE3D5FS10Cx A00/1

		Datum 26.10.2012		EPLAN Software & Service Saia-Burgess Makroprojekt	 Control Systems and Components	Saia-Burgess Controls Ltd.		Allpolig		= Energy meter	
		Bearb. KAF								+ ALE3D5FM10Cx A00	
		Gepr									
Änderung	Datum	Name	Urspr	Ersatz von	Ersetzt durch					Blatt 522	

AWD3D5W10MCxA00

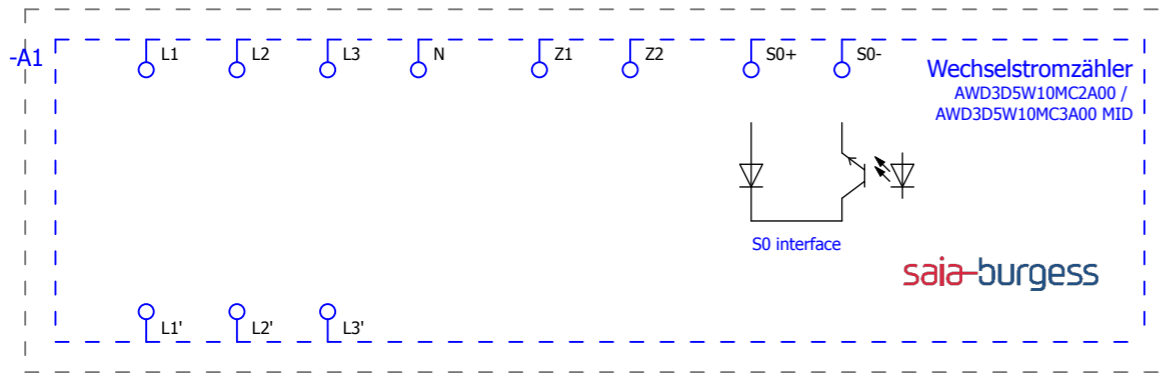

Saia-Burgess\Energy meter\AWD3D5W10MCxA00.ema
 Multi-line
 Variant A
 2012-10-26 / 2.1.4

		Datum 26.10.2012		EPLAN Software & Service Saia-Burgess Makroprojekt	Saia-Burgess Controls Ltd. Control Systems and Components	Allpolig		= Energy meter		
		Bearb. KAF						+ AWD3D5W10MCxA00		Blatt 1
		Gepr								Blatt 522
Änderung	Datum	Name	Urspr	Ersatz von	Ersetzt durch					

AWD3D5W10NDxA00

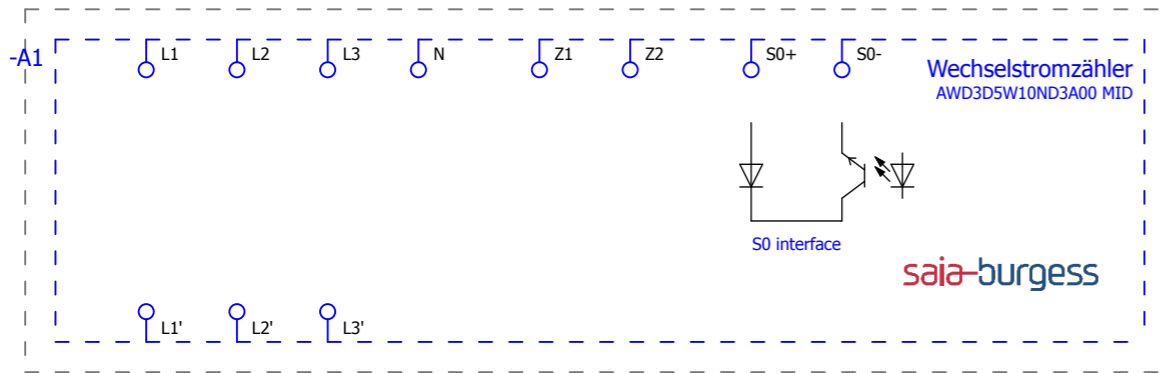

Saia-Burgess\Energy meter\AWD3D5W10NDxA00.ema
 Multi-line
 Variant A
 2012-10-26 / 2.1.4

+AWD3D5W10MCxA00/1

+AWD3D5WM00CxA00/1

		Datum 26.10.2012		EPLAN Software & Service Saia-Burgess Makroprojekt	Saia-Burgess Controls Ltd. Control Systems and Components	Saia-Burgess Controls Ltd.	Allpolig	= Energy meter		Blatt 1	
		Bearb. KAF						+ AWD3D5W10NDxA00			Blatt 522
		Gepr									
Änderung	Datum	Name	Urspr	Ersatz von	Ersetzt durch					Blatt 522	

AWD3D5WM00CxA00

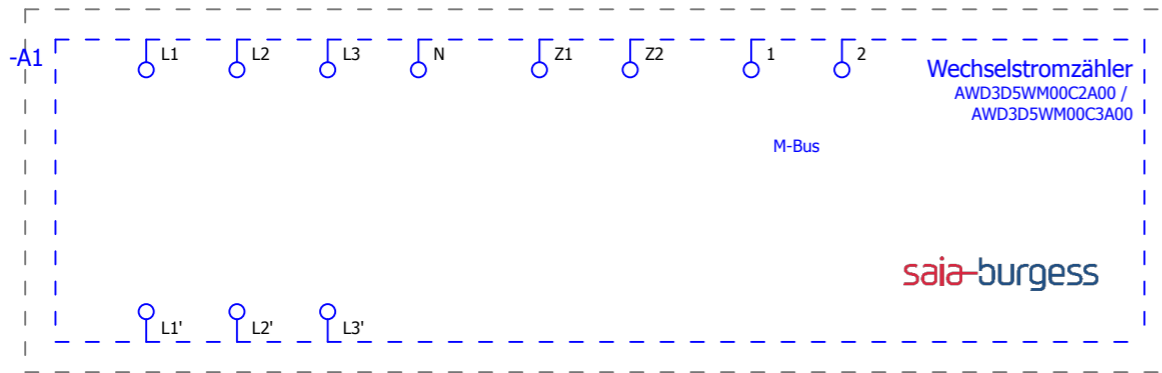

Saia-Burgess\Energy meter\AWD3D5WM00CxA00.ema
 Multi-line
 Variant A
 2012-10-26 / 2.1.4

+AWD3D5W10NDxA00/1

+AWD3D5WS00CxA00/1

			Datum	26.10.2012	EPLAN Software & Service Saia-Burgess Makroprojekt	 Control Systems and Components	Saia-Burgess Controls Ltd.	Allpolig		= Energy meter			
			Bearb.	KAF							+ AWD3D5WM00CxA00		
			Gepr										Blatt 1
Änderung	Datum	Name	Urspr		Ersatz von	Ersetzt durch						Blatt 522	

AWD3D5WS00CxA00

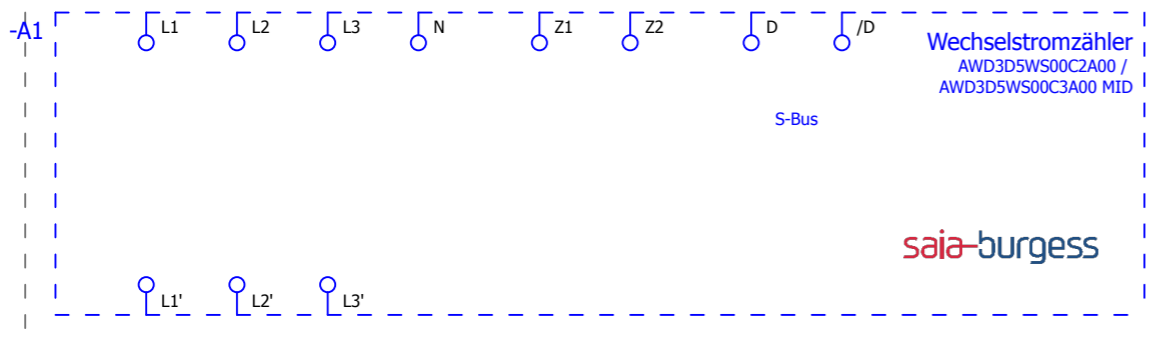

Saia-Burgess\Energy meter\AWD3D5WS00CxA00.ema
 Multi-line
 Variant A
 2012-10-26 / 2.1.4

+AWD3D5WM00CxA00/1

+AWD3D5WS00D2A00/1

			Datum	26.10.2012	EPLAN Software & Service Saia-Burgess Makroprojekt	 Control Systems and Components	Saia-Burgess Controls Ltd.	Allpolig		= Energy meter		
			Bearb.	KAF							+ AWD3D5WS00CxA00	
			Gepr									Blatt 1
Änderung	Datum	Name	Urspr		Ersatz von	Ersetzt durch					Blatt 522	

AWD3D5WD00CxA00

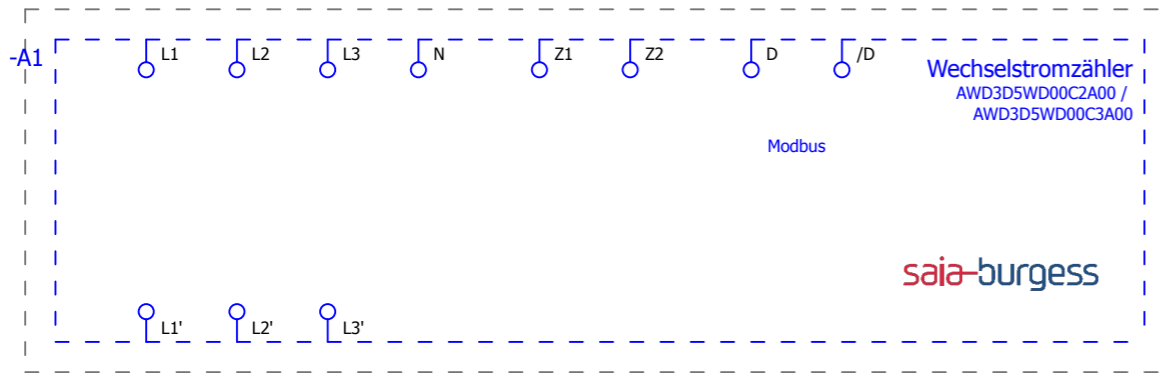

Wechselstromzähler
AWD3D5WD00C2A00 /
AWD3D5WD00C3A00

Modbus

saia-burgess

Saia-Burgess\Energy meter\AWD3D5WD00CxA00.ema
Multi-line
Variant A
2012-10-26 / 2.1.4

+AWD3D5WS00D2A00/1

+AWD3B5W10MCxA00/1

		Datum		26.10.2012		EPLAN Software & Service		Saia-Burgess Controls Ltd.		Allpolig		= Energy meter	
		Bearb.		KAF		Saia-Burgess Makroprojekt		Control Systems and Components				+ AWD3D5WD00CxA00	
		Gepr										Blatt 1	
Änderung		Datum		Name		Urspr		Ersatz von		Ersetzt durch		Blatt 522	

AWD3B5W10MCxA00

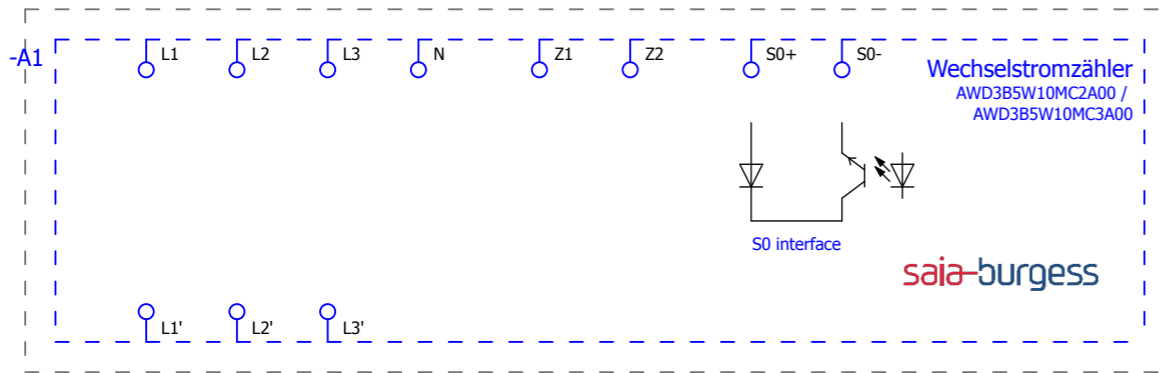

Saia-Burgess\Energy meter\AWD3B5W10MCxA00.ema
 Multi-line
 Variant A
 2012-10-26 / 2.1.4

			Datum	26.10.2012	EPLAN Software & Service Saia-Burgess Makroprojekt	Saia-Burgess Controls Ltd. Control Systems and Components	Saia-Burgess Controls Ltd.	Allpolig	= Energy meter		Blatt 1	
			Bearb.	KAF					+ AWD3B5W10MCxA00			Blatt 522
			Gepr									
Änderung	Datum	Name	Urspr		Ersatz von	Ersetzt durch						

AWD3B5WS00CxA00

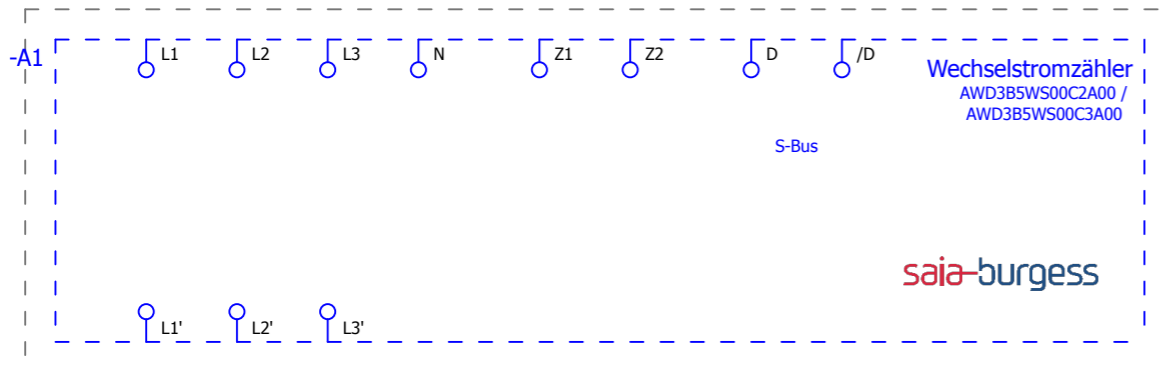

Saia-Burgess\Energy meter\AWD3B5WS00CxA00.ema
 Multi-line
 Variant A
 2012-10-26 / 2.1.4

+AWD3B5W10MCxA00/1

			Datum	26.10.2012	EPLAN Software & Service Saia-Burgess Makroprojekt	 Control Systems and Components	Saia-Burgess Controls Ltd.	Allpolig		= Energy meter	
			Bearb.	KAF						+ AWD3B5WS00CxA00	
			Gepr								Blatt
Änderung	Datum	Name	Urspr		Ersatz von	Ersetzt durch				Blatt	522