

Montage- und Bedienungsanleitung Typ ALD1D5FM

32 A-Wirkenergiezähler 1-phasig mit M-Bus Schnittstelle, Pic. 1

Beschreibung

Energiezähler mit integrierter M-Bus Schnittstelle ermöglichen das Auslesen aller relevanten Daten wie Zählerstand, Strom, Spannung, Leistung (Wirk- und Blindleistung).

Technische Daten

| | |
|-------------------------------------|---|
| Anschlussbild | ■ Pic. 2 |
| Abmessungen | ■ Pic. 3 |
| Genauigkeitsklasse | ■ B gemäss EN50470-3, 1 gemäss IEC62053-21 |
| Referenz-, Maximal-, Anlaufstrom | ■ I _{ref} = 5 A, I _{max} = 32 A, I _{st} = 20 mA |
| Betriebsspannung | ■ 230 VAC, 50 Hz Toleranz -20%/+15% |
| Zählbereich | ■ 00000,00...999999,9 kWh |
| Anschlüsse Hauptstromkreis | ■ Leiterquerschnitt max. 6 mm ² , Schraubendreher Pozi Nr. 1, Schlitz Nr. 1, Anzugsmoment 1,2 Nm |
| Anschlüsse Steuerstromkreis | ■ Leiterquerschnitt max. 2,5 mm ² , Schraubendreher Pozi Nr. 0, Schlitz Nr. 1, Anzugsmoment 0,5 Nm |
| Betriebstemperatur | ■ -25... +55 °C (nicht kondensie- rend gemäss Norm EN50470) |
| Umgebungs- bedingungen | ■ Mechanische M2 Elektromagnetische E2 |

Anzeigeelemente (Pic. 4)

| | |
|---------------|---|
| T total (kWh) | ■ Zeigt den Verbrauch Total |
| T part (kWh) | ■ Zeigt den partiellen Verbrauch, dieser Wert ist rückstellbar |
| P (kW) | ■ Zeigt die momentane Leistung |
| U (V) | ■ Zeigt die Spannung |
| I (A) | ■ Zeigt den Strom |
| 2000 Imp/kWh | ■ Pulsiert entsprechend der bezogenen Leistung. Bei Fehler (Anschlüsse 1L/2L vertauscht) pulsiert das Segment mit 600/600 ms. |

Hinweise vor dem Anschliessen

Um Feuchtigkeit im Zähler durch Kondenswasser zu vermeiden, den Zähler vor dem Anschliessen rund eine halbe Stunde bei Raumtemperatur akklimatisieren.

Achtung!

Diese Geräte dürfen nur durch eine Elektrofachkraft installiert werden, andernfalls besteht Brandgefahr oder Gefahr eines elektrischen Schlages!

Bedienung der LCD-Anzeige

Siehe Seite mit LCD-Menüführung.

Montagehinweis

Die Energiezähler lassen sich auf eine 35 mm Schiene (EN60715TH35) aufschrauben. Sie dürfen nur in dazu geeigneten Installationsschränken verwendet werden.

EG-Konformitätserklärung

Wir, Saia-Burgess Controls AG, CH 3280 Murten (Schweiz), erklären in alleiniger Verantwortung, dass die Energiezählerprodukte:

- ALD1D5FM00A3A00
- ALD1D5FM00A3A09

auf die sich die Erklärung bezieht, mit der Richtlinie 2014/32/EU und den folgenden Normen oder normativen Dokumenten übereinstimmen:

- EN50470 Teile 1 und 3 (Elektronische Zähler),
Oktober 2006.
ESD auf Apparateseite: 13 kV.
- Richtlinie 2014/30/EG (EMC)
- Richtlinie 2014/35/EG (LVD)

Konformitätsbewertungsstelle:

METAS-Cert, Nr. 1259
CH-3003 Bern-Wabern

Givisiez, im Februar 2022

Gezeichnet: Maarit White, EMEA Quality Leader - BMS



Made in Romania



UK Importer Address:
Honeywell Building Technologies
Building 5 Carlton Park
King Edward Avenue
Narborough, Leicester LE19 3EQ

Technische Daten M-Bus

| | |
|--|--|
| Bus System | M-Bus |
| Norm | EN13757 |
| Bus Länge | Gemäss M-Bus Spezifikation |
| Übertragungsraten | 300, 2400, 9600 Bd (ab Werk 2400 Bd) Die Übertragungsrate ist via Display/M-Bus wählbar |
| Reaktionszeit (Systemreaktionszeit) | Schreiben: bis 60 ms Lesen: bis 60 ms |

Datenübertragung



- Beim Auslesen der Werte werden alle Werte in einem Telegramm übertragen.
- Es werden folgende Telegramme unterstützt:

| | | |
|--|---------|-----------------|
| • Initialisierung | SND_NKE | Antwort: ACK |
| • Zähler auslesen | REQ_UD2 | Antwort: RSP_UD |
| • Primäradresse ändern | SND_UD | Antwort: ACK |
| • Reset T _{start} | SND_UD | Antwort: ACK |
| • Slave-Auswahl für die Sekundär-Adresse | SND_UD | Antwort: ACK |
| • Ändern der Baudrate | SND_UD | Antwort: ACK |

 (Detaillierte Angaben erhalten Sie auf der Website www.sbc-support.com unter dem Dokument 26-530)
- Das Gerät antwortet nicht auf unbekannte Abfragen.
- Das Gerät hat eine Spannungsüberwachung. Im Falle eines Spannungsverlusts werden alle Register im EEPROM gespeichert.

Ändern der M-Bus Primäradresse

- Um die M-Bus Adresse zu ändern, im Menü bis «U» (Voltage) gehen.
- Die Taste  3 Sekunden lang drücken.
- Im folgenden Menü,



| | |
|--|---------------------------------|
| kurzer Tastendruck  | erhöht die Adresse um 1, |
| langer Tastendruck  | erhöht die Primäradresse um 10. |
- Wenn die gewünschte Primäradresse eingestellt ist, warten Sie bis das Hauptmenü wieder erscheint.

Sekundär-Adresse

- Mithilfe der Sekundär-Adresse ist es möglich mit dem Energiezähler zu kommunizieren, gemäss der Norm EN13757.
- Die Verwendung von Wild Cards ist möglich.

Ändern der Baudrate

Variante 1 (Lokal mittels Tasten und LCD):

- Um die M-Bus Baudrate zu ändern, halten Sie 3 Sek  gedrückt
- Im folgenden Menü,  wechselt die Baudrate von 300 zu 2400 und zu 9600 Baud
- Wenn die gewünschte M-Bus Baudrate eingestellt ist, warten Sie bis das Hauptmenü wieder erscheint

Variante 2 (Mittels M-Bus):

- | | | | | | | | | | | | |
|----------------|---|------------|------|------|------|------|------|--------|------|------|------|
| ■ Senden: 9600 | → | Telegramm: | 0x68 | 0x03 | 0x03 | 0x68 | 0x43 | <addr> | 0xB8 | <cs> | 0x16 |
| 2400 | → | Telegramm: | 0x68 | 0x03 | 0x03 | 0x68 | 0x43 | <addr> | 0xBB | <cs> | 0x16 |
| 300 | → | Telegramm: | 0x68 | 0x03 | 0x03 | 0x68 | 0x43 | <addr> | 0xBB | <cs> | 0x16 |

- Antwort: 0xE5 (Mit alter Baudrate gesendet)
- Nach dem Ändern der Baudrate muss der M-Bus-Master innerhalb 10 Minuten mit der neuen Baudrate mit dem M-Bus-Slave kommunizieren. Damit wird die Baudratenänderung bestätigt (EN13757-3).

Saia-Burgess Controls AG

Route Jo-Siffert 4 | 1762 Givisiez | Switzerland
T +41 26 580 30 00 | F +41 26 580 34 99
www.sbc-support.com

Assembly and operating instructions Type ALD1D5FM

32 A Single Phase active power energy meter with M-Bus interface, Pic. 1

Description

Energy meter with M-Bus interface enables the reading of all relevant data like meter reading, electricity, voltage, power (active and reactive).

Technical data

| | |
|---|---|
| Connection diagram | ■ Pic. 2 |
| Dimensions | ■ Pic. 3 |
| Accuracy class | ■ B according to EN50470-3, 1 according to IEC62053-21 |
| Reference, Maximum, initial current operating voltage | ■ $I_{ref} = 5 \text{ A}$, $I_{max} = 32 \text{ A}$, $I_{st} = 20 \text{ mA}$ |
| Counting range | ■ 230 VAC, 50 Hz Tolerance $-20\%/+15\%$ |
| Connections Main circuit | ■ 00000,00...999 999,9 kWh ■ Conductor cross-section max. 6mm ² , screwdriver pozi no. 1, slot no. 1, torque 1,2 Nm |
| Connections Control circuit | ■ Conductor cross-section max. 2,5mm ² , screwdriver pozi no.0, slot no. 1, torque 0,5 Nm |
| Operating temperature | ■ $-25...+55^{\circ}\text{C}$ (noncondensing according standard EN50470) |
| Environment | ■ Mechanical M2 Electromagnetic E2 |

Indicating elements (Pic. 4)

| | |
|-----------------|--|
| T total (kWh) | ■ Indicates the total consumption |
| T part (kWh) | ■ Indicates the partial consumption. This value can be reset |
| P (kW) | ■ Indicates the instantaneous power |
| U (V) | ■ Indicates the voltage |
| I (A) | ■ Indicates the current |
| 2000 pulses/kWh | ■ Pulsates according to the amount of used power. Error indication (line 1L/2L inverted) with pulse of 600/600 ms. |

Notes before connecting

In order to avoid moisture in the meter due to condensate build-up, acclimatise the meter at room temperature for about half an hour before connecting.

Attention!

These devices must only be installed by a professional electrician, otherwise there is the risk of fire or the risk of an electric shock.

Operation of the LCD display

See page with LCD menu navigation.

Installation instructions

The energy meter can be attached to a 35 mm rail (EN60715TH35).

The meter can be used only in installation cabinets.

Declaration of Conformity CE

We, Saia-Burgess Controls AG, CH 3280 Murten (Switzerland), herewith declare, on our own responsibility that the products:

- ALD1D5FM00A3A00
- ALD1D5FM00A3A09

which this certificate refer to, are in accordance with the directive 2014/32/EU (MID) and the following standards:

- EN50470 parts 1 and 3 (electronic meter), of October 2006.
ESD on equipment side: 13 kV.
- Directive 2014/30/EG (EMC)
- Directive 2014/35/EG (LVD)

Conformity Assessment Body:

METAS-Cert, Nr. 1259
CH-3003 Bern-Wabern

Govisiez, February 2022

Signed: Maarit White, EMEA Quality Leader - BMS



Made in Romania



UK Importer Address:
Honeywell Building Technologies
Building 5 Carlton Park
King Edward Avenue
Narborough, Leicester LE19 3EQ

Technical data M-Bus

| | |
|------------------------------------|---|
| Bus system | M-Bus |
| Standard | EN13757 |
| Bus length | According to M-Bus specification |
| Transmission rates | 300, 2400, 9600 Bd (factory setting: 2400 Bd). The transmission rate can be changed via display/M-Bus. |
| Response time (System response) | Write: up to 60 ms Read: up to 60 ms |

Data transfer

- When reading out the values, all values are transferred in a telegram.
- It supports the following telegrams:

| | | |
|--|---------|------------------|
| • Initialisation | SND_NKE | Response: ACK |
| • Reading meter | REQ_UD2 | Response: RSP_UD |
| • Changing primary address | SND_UD | Response: ACK |
| • Reset T _{max} | SND_UD | Response: ACK |
| • Slave selection for secondary addressing | SND_UD | Response: ACK |
| • The transmission rate is changeable | SND_UD | Response: ACK |

(Further information you will find on the website www.sbc-support.com under the document 26-530)
- The device does not respond to unknown queries.
- The device has a voltage monitor. In the case of a power failure, all the registers in the EEPROM are saved.

Changing the M-Bus primary address

- In the menu, go for «U»
- Push long (≥ 3 sec) «Adr ...»
- In the following menu:

| | |
|------------|-------------------|
| push short | M-Bus address +1, |
| push long | M-Bus address +10 |
- When the desired address is set, wait until the main display appears again.

Secondary addressing

- It is possible to communicate with the energy meter using the secondary address, according to EN13757
- The use of Wild Cards is possible

Changing the baud rate

Variant 1 (local keys and LCD):

- In order to change the M-Bus baud rate, hold down touch for 3 sec
- In the following menu, changes the baud rate from 300 to 9600 baud and 2400
- When the desired M-Bus baud rate is set, wait until the main display appears again

Variante 2 (using M-Bus):

- Send: 9600 → Telegram: 0x68 0x03 0x03 0x68 0x43 <addr> 0xBD <cs> 0x16
- Send: 2400 → Telegram: 0x68 0x03 0x03 0x68 0x43 <addr> 0xBB <cs> 0x16
- Send: 300 → Telegram: 0x68 0x03 0x03 0x68 0x43 <addr> 0xB8 <cs> 0x16
- Response: 0xE5 (sent with the former baud rate)
- A M-Bus master must communicate within 10 minutes to the M-Bus slave on the new baud rate to validate and save the baud rate change permanent (EN13757-3).

Saia-Burgess Controls AG

Route Jo-Siffert 4 | 1762 Givisiez | Switzerland
T +41 26 580 30 00 | F +41 26 580 34 99
www.sbc-support.com

Istruzioni d'uso e montaggio Modello ALD1D5FM

Contatore d'energia attiva monofase 32 A con interfaccia M-Bus, Pic. 1

Descrizione

Il contatore d'energia con interfaccia seriale integrata consente la lettura tutti i dati rilevanti, quali registro del contatore, corrente, tensione, potenza (attiva e reattiva).

Dati tecnici

| | |
|---|---|
| Schema di collegamento | ■ Pic. 2 |
| Dimensioni d'ingombro | ■ Pic. 3 |
| Classe di precisione | ■ B secondo EN50470-3, 1 secondo IEC62053-21 |
| Corrente di riferimento, massima, di spunto | ■ $I_{ref} = 5 \text{ A}$, $I_{max} = 32 \text{ A}$, $I_{st} = 20 \text{ mA}$ |
| Tensione d'esercizio | ■ 230 VAC, 50 Hz |
| Capacità di conteggio | ■ Tolleranza $-20\%/+15\%$ 00000,00 à 999999,9 kWh |
| Morsetti circuito principale | ■ Sezione conduttori max. 6 mm ² , cacciavite Pozi nr. 1, a taglio nr. 1, coppia di serraggio 1,2 Nm |
| Morsetti circuito di comando | ■ Sezione conduttori max. 2,5 mm ² , cacciavite Pozi nr. 0, a taglio nr. 1, coppia di serraggio 0,5 Nm |
| Temperatura d'esercizio | ■ -25 à $+55^{\circ}\text{C}$ (assenza di condensa secondo la norma EN50470) |
| Ambienti | ■ Meccanici M2 Elettromagnetici E2 |

Elementi del display (Pic. 4)

| | |
|------------------|--|
| T total (kWh) | ■ Indica il consumo totale |
| T part (kWh) | ■ Indica il consumo parziale. Questo valore si può resettare. |
| P (kW) | ■ Indica l'uscita istantanea |
| U (V) | ■ Indica la tensione |
| I (A) | ■ Indica la corrente |
| 2000 impulsi/kWh | ■ Impulsi secondo l'uscita indicata. Indicazione dell'errore (inver- sione connessioni 1L/2L) pulsa di tempo di ciclo 600/600 ms. |

Note per il collegamento

Per evitare la presenza di umidità nel contatore in seguito alla formazione di condensa, prima del collegamento lasciare il contatore per circa mezz'ora a temperatura ambiente

Attenzione!

Questi apparecchi devono essere installati esclusivamente da elettricisti specializzati, onde evitare rischi di incendio o pericoli di scosse elettriche!

Funzione del display LCD

Per ulteriori dettagli vedi pagina LCD con menù guidato.

Istruzioni di montaggio

I contatori di energia si installano su guida da 35 mm (EN60715TH35). Devono essere installati solo in quadri o centralini.

Dichiarazione di conformità CE

Noi, Saia-Burgess Controls AG, CH 3280 Murten (Svizzera), dichiariamo in nostra propria responsabilità che i prodotti:

- ALD1D5FM00A3A00
- ALD1D5FM00A3A09

di quali si riferisce questa dichiarazione rispondono alla direttiva 2014/32/EU (MID) e alle normative seguenti:

- normativa EN50470 Parte 1 e 3 (Contatori elettronici). Ottobre 2006
- ESD sul lato dell'apparato: 13 kV
- Direttiva 2014/30/EG (EMC)
- Direttiva 2014/35/EG (LVD)

Organismi di valutazione della conformità:
METAS-Cert, Nr. 1259
CH-3003 Bern-Wabern

Visisiez, febbraio 2022

Firmato: Maarit White, EMEA Quality Leader - BMS



Made in Romania



UK Importer Address:
Honeywell Building Technologies
Building 5 Carlton Park
King Edward Avenue
Narborough, Leicester LE19 3EQ

Dati tecnici M-Bus

| | |
|--------------------------|--|
| Sistema Bus | M-Bus |
| Normative | EN13757 |
| Lunghezza del bus | Secondo la specifica M-Bus |
| Velocità di trasmissione | 300, 2400, 9600 Bd (impostazione di fabbrica: 2400 Bd). La velocità di trasmissione è selezionabile tramite il display/M-Bus. |
| Tempo di reazione | Scrittura: fino a 60 ms Lettura: fino a 60 ms |



Trasmissione dei dati

- Quando si leggono i valori, tutti i valori vengono trasmessi in un unico messaggio.
- Supporta i seguenti telegrammi:

| | | |
|---|---------|------------------|
| • Inizializzazione | SND_NKE | Risposta: ACK |
| • Lettura del contatore | REQ_UD2 | Risposta: RSP_UD |
| • Cambio dell'indirizzo principale | SND_UD | Risposta: ACK |
| • Reset T _{start} | SND_UD | Risposta: ACK |
| • Selezione dello slave per l'indirizzamento secondario | SND_UD | Risposta: ACK |
| • Modifica della velocità di trasmissione | SND_UD | Risposta: ACK |

 (Informazioni dettagliate sono disponibili sul sito web www.sbc-support.com nel documento 26-530)
- L'apparecchio non risponde alle richieste non riconosciute
- Il dispositivo è dotato di un sistema di monitoraggio della tensione. In caso mancanza della tensione di alimentazione, tutti i registri vengono salvati nella EEPROM.

Modifica dell'indirizzo principale del M-Bus



- Nel menu, andare per «U»
- Per modificare l'indirizzo M-Bus tenete premuto il tasto  per 3 secondi, quindi premere premere breve  indirizzo M-Bus cresce di 1, premere a lungo  indirizzo M-Bus cresce di 10
- Al raggiungimento dell'indirizzo primario desiderato attendere finché riappare la visualizzazione principale

Indirizzo secondario

- E' possibile comunicare con il contatore tramite l'utilizzo dell'indirizzo secondario, in conformità con la norma EN13757
- L'utilizzo di Wild Cards è possibile

Per modificare la velocità di trasmissione

Versione 1 (con tasti locali e LCD):

- Per modificare il baud rate di M-Bus tenete premuto il tasto  per 3 secondi
- Nel menu seguente,  cambia il baud rate da 300 a 9600 baud e 2400 baud
- Al raggiungimento del baud rate desiderato attendere finché riappare la visualizzazione principale

Versione 2 (utilizzando M-Bus):

- Trasmissione:

| | | | | | |
|------|---|---|-------------|------|------|
| 9600 | → | telegramma: 0x68 0x03 0x03 0x68 0x43 <addr> | 0xBD | <cs> | 0x16 |
| 2400 | → | telegramma: 0x68 0x03 0x03 0x68 0x43 <addr> | 0xBB | <cs> | 0x16 |
| 300 | → | telegramma: 0x68 0x03 0x03 0x68 0x43 <addr> | 0xB8 | <cs> | 0x16 |
- Risposta: 0xE5 (inviato con il vecchio baud rate)
- Per convalidare e salvare le modifiche in modo permanente, il master M-Bus deve comunicare, per i prossimi 10 minuti, con lo slave con la nuova velocità di trasmissione (EN13757-3).

Saia-Burgess Controls AG

Route Jo-Siffert 4 | 1762 Givisiez | Switzerland
T +41 26 580 30 00 | F +41 26 580 34 99
www.sbc-support.com

Instructions de montage et d'utilisation ALD1D5FM

Compteur d'énergie active monophasé 32 A avec interface M-Bus, Pic.1

Description

Les compteurs d'énergie avec interface M-Bus permettent le relevé de toutes les données importantes telles que la valeur du compteur, le courant, la tension, la puissance (active et réactive).

Caractéristiques techniques

| | |
|---|--|
| Schéma de raccordement | ■ Pic. 2 |
| Dimensions | ■ Pic. 3 |
| Classe de précision | ■ B selon EN50470-3, 1 selon IEC62053-21 |
| Courant de référence, maximal, de démarrage | ■ I _{ref} = 5 A, I _{max} = 32 A, I _{st} = 20 mA |
| Tension de service | ■ 230 VAC, 50 Hz Tolérance -20%/+15% |
| Plage de comptage | ■ 00000,00...999 999,9 kWh |
| Branchements | ■ Section de conducteur max. 6 mm ² , tournevis pozi n° 1, plat n° 1, couple de serrage 1,2 Nm |
| Circuit d'alimentation | ■ Section de conducteur maximal 2,5 mm ² , tournevis pozi n° 0, plat n° 1, couple de serrage 0,5 Nm |
| Branchements | ■ Section de conducteur maximal 2,5 mm ² , tournevis pozi n° 0, plat n° 1, couple de serrage 0,5 Nm |
| Circuit de commande | ■ Section de conducteur maximal 2,5 mm ² , tournevis pozi n° 0, plat n° 1, couple de serrage 0,5 Nm |
| Température de service | ■ -25...+55°C (sans condensation selon la norme EN50470) |
| Environnement | ■ Mécanique M2 electromagnétiques E2 |

Éléments d'affichage (Pic. 4)

| | |
|-----------------|--|
| T total (kWh) | ■ Consommation totale |
| T part (kWh) | ■ Consommation partielle . (RAZ possible). |
| P (kW) | ■ Puissance instantanée |
| U (V) | ■ Tension |
| I (A) | ■ Courant |
| 2000 pulses/kWh | ■ Impulsions en fonction de la puissance absorbée. Indication d'erreur (inversion de ligne), impulsion 600/600 ms. |

Remarque préalable au raccordement

Afin d'éviter la formation de condensation dans le compteur, laisser celui-ci s'acclimater pendant env. une demi heure à la température ambiante du local.

Attention!

Ces appareils doivent être uniquement installés par un spécialiste en électricité pour éviter tout risque d'incendie ou d'électrocution!

Utilisation de l'écran LCD

Voir la page avec le guidage de menu LCD.

Instructions de montage

Les compteurs d'énergie peuvent être encliquetés sur un rail de 35 mm (EN60715TH35). Ils ne peuvent être utilisés que dans des armoires électriques.

Déclaration de conformité CE

Nous, Saia-Burgess Controls AG, CH 3280 Murten (Suisse), déclarons sous notre propre responsabilité que les produits:

- ALD1D5FM00A3A00
- ALD1D5FM00A3A09

pour lesquels cette déclaration se réfère sont conformes à la directive 2014/32/EU (MID) et aux normes suivantes:

- EN50470 Parties 1 et 3 (Compteurs électroniques).
Octobre 2006
ESD sur le côté de l'appareil : 13 kV
- Directive 2014/30/EG (EMC)
- Directive 2014/35/EG (LVD)

Organismes d'évaluation de la conformité:

METAS-Cert, Nr. 1259
CH-3003 Bern-Wabern

Visivis, en février 2022

Signé : Maarit White, EMEA Quality Leader - BMS

Caractéristiques techniques du M-Bus

| | |
|-------------------|--|
| Système de bus | M-Bus |
| Norme | EN13757 |
| Longueur du bus | Selon la spécification du M-Bus |
| Taux de transfert | 300, 2400, 9600 Bd (valeur d'usine : 2400 Bd) Le taux de transfert est sélectionnable via l'affichage/M-Bus |
| Temps de réaction | Ecriture : jusqu'à 60 ms Lecture : jusqu'à 60 ms |

Transfert de données



- Lors du relevé des valeurs, toutes les valeurs sont transmises par un télégramme.
- Les télégrammes suivants sont compatibles:

| | | |
|--|---------|------------------|
| • Initialisation | SND_NKE | Réponse : ACK |
| • Relever le compteur | REQ_UD2 | Réponse : RSP_UD |
| • Modifier l'adresse primaire | SND_UD | Réponse : ACK |
| • Reset T _{start} | SND_UD | Réponse : ACK |
| • Sélection de l'esclave pour l'adressage secondaire | SND_UD | Réponse : ACK |
| • Modifier le taux de transmission | SND_UD | Réponse : ACK |

 (Des informations détaillées sont disponibles sur le site web www.sbc-support.com sous le document 26-530)
- L'appareil ne répond pas aux requêtes inconnues.
- L'appareil est doté d'une surveillance de la tension. En cas de perte de tension, tous les données sont sauvegardées dans l'EEPROM.

Modification de l'adresse primaire de M-Bus

- Dans le menu, allez à « U ».
- Pour modifier l'adresse du M-Bus, maintenir la touche  appuyée pendant 3 secondes.
- Dans le menu suivant,



| | |
|---|-------------------|
| Appui court  | M-Bus adresse +1 |
| appui long  | M-Bus adresse +10 |
- Lorsque l'adresse primaire souhaitée est réglée, attendre que le menu principal s'affiche de nouveau.

Adressage secondaire

- Il est possible de communiquer avec le compteur grâce à l'adresse secondaire, selon la norme EN13757
- L'usage de Wild Card est également possible

Pour modifier le baud rate

Variante 1 (avec touches locales et LCD) :

- Pour modifier le baud rate du M-Bus, maintenir la touche  appuyée pendant 3 secondes
- Dans le menu suivant,  modifie le baud rate de 300 à 9600 bauds et 2400 bauds
- Lorsque le baud rate désiré est réglé, attendre que le menu principal s'affiche à nouveau

Variante 2 (en utilisant M-Bus) :

- Transmission:

| | | | | | |
|------|---|---|-------------|------|------|
| 9600 | → | télégramme: 0x68 0x03 0x03 0x68 0x43 <addr> | 0xBD | <cs> | 0x16 |
| 2400 | → | télégramme: 0x68 0x03 0x03 0x68 0x43 <addr> | 0xBB | <cs> | 0x16 |
| 300 | → | télégramme: 0x68 0x03 0x03 0x68 0x43 <addr> | 0xB8 | <cs> | 0x16 |
- Réponse: 0xE5 (envoyé avec l'ancien baud rate)
- Pour valider et enregistrer le changement permanent, le maître «M-Bus» doit communiquer dans les prochaines 10 minutes avec l'esclave et avec le nouveau baud rate (EN13757-3).

Saia-Burgess Controls AG

Route Jo-Siffert 4 | 1762 Givisiez | Switzerland
T +41 26 580 30 00 | F +41 26 580 34 99
www.sbc-support.com



431951120H



**UK
CA
EAC**

Pic. 1

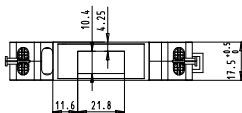
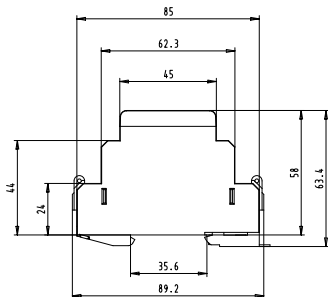

Pic. 3

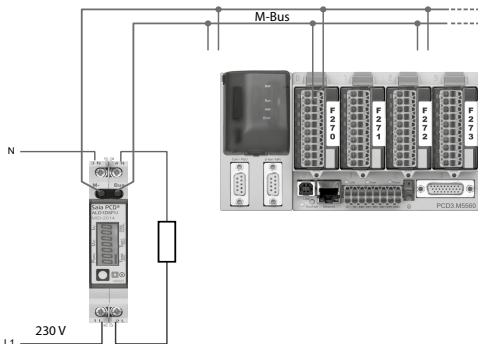

Pic. 2

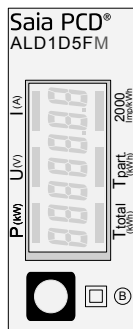

Pic. 4

Value information field (VIF)

Provides information on multiplier and the unit of the following data block

Value information field extension (VIFE)

Detailed information on multiplier and the unit of the following data block

Data information field (DIF)

Specifies how the data should be interpreted by the master in terms of length and encoding

Data information field extension (DIFE)

Provides information on the tariff or subunits of the following data block

Reading meter

Query: REQ_UD2

Response: RSP_UD (see Telegram structure)

Telegram structure

| | | | | | | | | | | |
|-----------------------------|------|------|------|------|------|------|------|------|------|------|
| 0x68 | 0x38 | 0x38 | 0x68 | 0x08 | PAdr | 0x72 | ID | 0x43 | 0x4c | DEV |
| 02 | ACC | STAT | 0 | 0 | 0x8c | 0x10 | 0x04 | Eto | 0x8c | 0x11 |
| 0x04 | Epa | 0x02 | 0xFD | 0xC9 | 0xFF | 0x01 | V | 0x02 | 0xFD | 0xDB |
| 0xFF | 0x01 | I | 0x02 | 0xAC | 0xFF | 0x01 | P | 0x82 | 0x40 | 0xAC |
| 0xFF | 0x01 | Pr | CSum | 0x16 | | | | | | |
| Variable at 1, 2 or 4 bytes | | | | | | | | | | |

| Byte | Content | Type | Description |
|---------|---------|-------------|----------------|
| 23 - 26 | Eto=x | 4 b. BCD | Energy total |
| 30 - 33 | Epa=x | 4 b. BCD | Energy partial |
| 39 - 40 | V=x | 2b. Integer | Voltage |
| 46 - 47 | I=x | 2b. Integer | Current |
| 52 - 53 | P=x | 2b. Integer | Power |
| 59 - 60 | Pr=x | 2b. Integer | Reactive Power |

| Unit with multiplier | | ALD1 | |
|-----------------------|------------------|------|--------|
| I | (Current) | 0.1 | [A] |
| U | (Voltage) | 1 | [V] |
| P _{active} | (Power) | 0.01 | [kW] |
| P _{reactive} | (Reactive Power) | 0.01 | [kVAR] |
| E | (Consumption) | 0.01 | [kWh] |

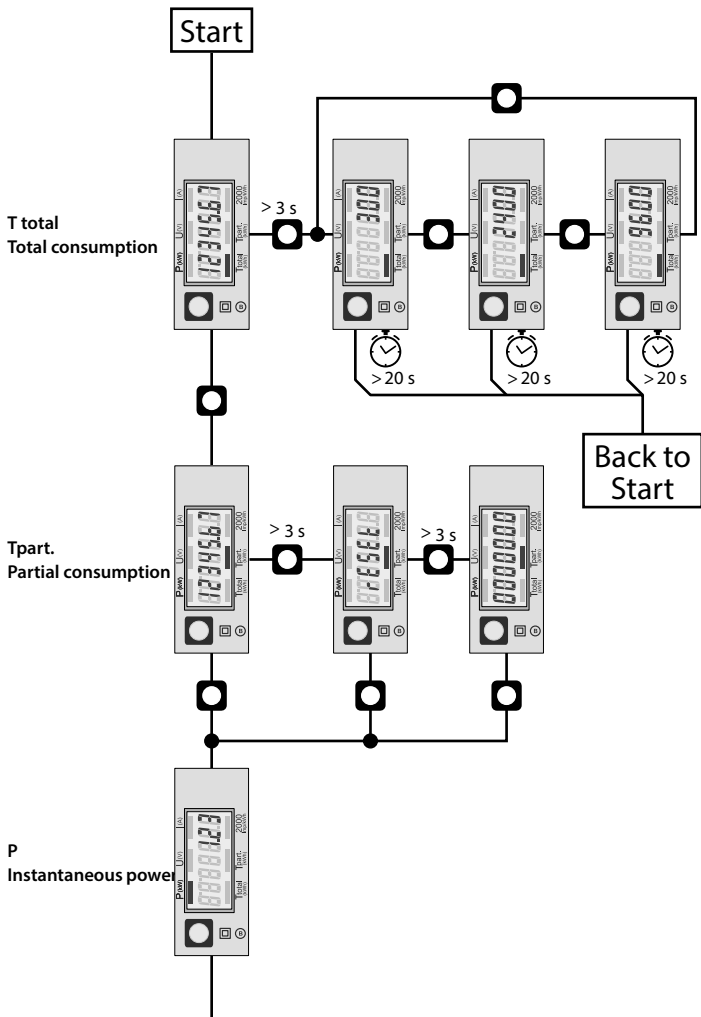

U
Voltage

I
Current

Change the M-Bus address

