

PCD3.W350

Analog input module, 8 channel, 12 bit, Pt100 / Ni100

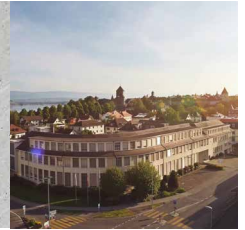

Fast, analog 8 channel input module with 12 bit resolution for Pt100 / Ni100 temperature sensors.
Use of a fast on-board micro controller allows decoupling and relief of the PCD regarding intensive computing tasks, such as scaling and filtering of signal data.

Technical specifications		
Number of inputs (channels)		8
Signal range	Pt100 Ni100	-50 ... +600 °C -50 ... +250 °C
Resolution (representation)		12 bit (0 ... 4095)
Resolution *)	Pt100 Ni100	0.14 ... 0.20 °C 0.06 ... 0.12 °C
Method of linearization for temperature inputs		by software
Galvanic separation		no
Measuring principle		non-differential, single-ended
Input resistance		nicht relevant
Maximum measurement current for temperature probes		1.5 mA
Accuracy at 25 °C		± 0.3 %
Repeating accuracy (under same conditions)		± 0.05 %
Temperature error (0 ... +55 °C)		± 0.2 %
Conversion time A/D		≤ 10 µs
EMV protection		yes
Time constant of input filter		typically 16.9 ms
Internal current consumption (from +5 V bus)		< 8 mA
Internal current consumption (from V+ bus)		< 30 mA
External current consumption		0 mA
Terminals		Pluggable 10-pole spring terminal block for Ø up to 2.5 mm ² , plug type A (4 405 4954 0)

*) value of least significant bit(LSB)



PCD3.W350

Block schematic

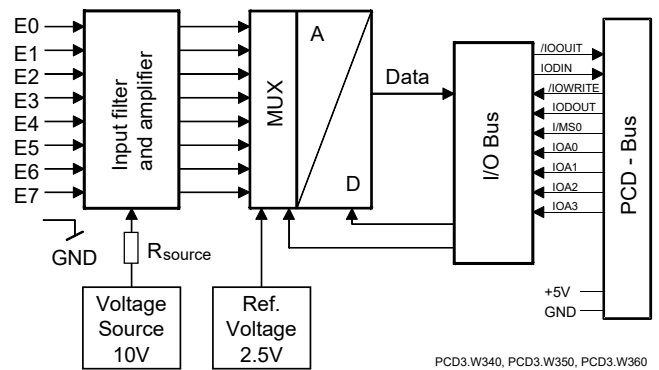

PCD3.W340, PCD3.W350, PCD3.W360

Indicators and connections

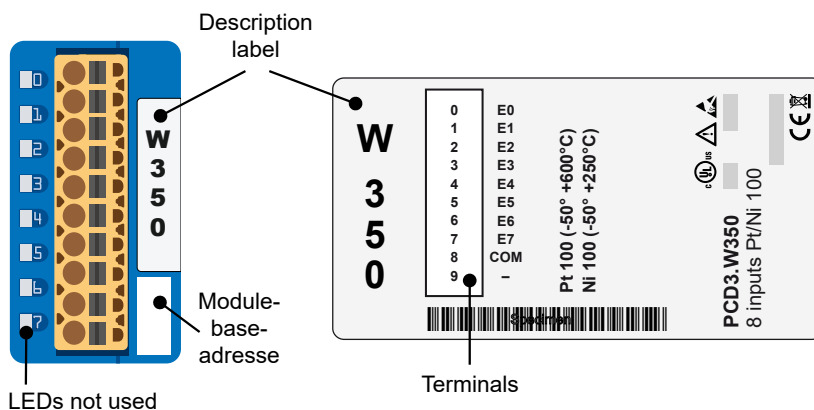

Connection concept

The voltage input signals are connected directly to the 10-pole terminal block (E0 ... E7 and COM). To minimize the amount of interference coupled into the module via the transmission lines, connection should be made according to the principle explained below.

Connection for Pt100 / Ni100

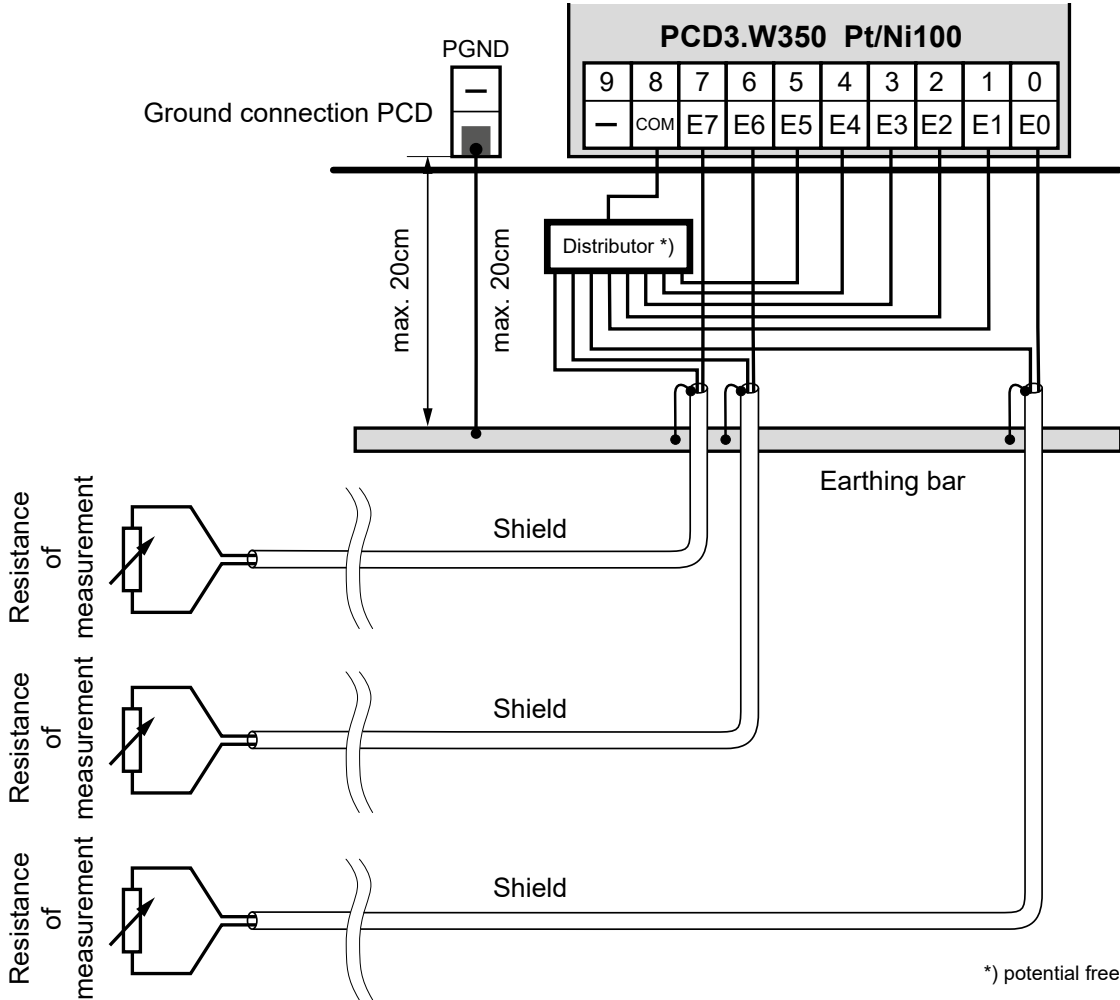

Good to now

- 

The reference potentials of signal sources should be wired to a common GND connection (“-” and “COM” terminals). To obtain optimum measurement results, any connection to an earthing bar should be avoided.
- 

If shielded cables are used, the shielding should be connected to an earthing rail.
- 

Input signals with incorrect polarity significantly distort the measurements on the other channels.

- 

Galvanic separation of inputs to CPU, channels themselves not separated.
- 

I/O modules and I/O terminal blocks may only be plugged in and removed when the CPU and the external +24 V are disconnected from the power supply.
- 

Watchdog .. in classic system
The watchdog with his address 255 can influence this module if it is used at the base address 240.

.. in IEC-controller system
is not affected

 **Further information**
This can be found in the Manual "27-600_I/O-modules for PCD1 / PCD2 series and for PCD3".

Configuration

Saia PG5® Controls Suite

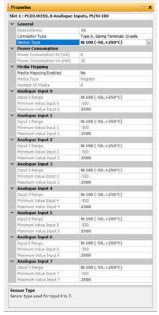
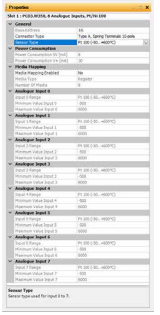
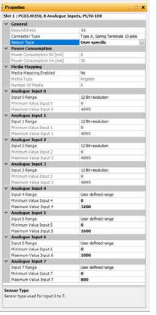
PCD-System	Evaluation
Classic	The evaluation is performed by the firmware. It reads the values according to the configuration (Device Configurator or Network Configurator).
	<div style="display: flex; justify-content: space-around;"> <div style="width: 30%;"> <p>Ni100</p>  </div> <div style="width: 30%;"> <p>Pt100</p>  </div> <div style="width: 30%;"> <p>User specific</p>  </div> </div>
Alternatively	<p>An FBox "PCD2/3.W350" exists for evaluation.</p> <p>FBox for PCD3.W350 (Inputs 0...7 selectable)</p> <div style="display: flex; justify-content: space-around;"> <div style="border: 1px solid black; padding: 5px;"> <p>PCD2/3.W350</p> <p>in0</p><p>in1</p><p>in2</p><p>in3</p><p>in4</p><p>in5</p><p>in6</p><p>in7</p><p>Error</p> <p>Add I80</p> </div> <div style="border: 1px solid black; padding: 5px;"> <p>PCD2/3.W350</p> <p>in0</p><p>Error</p> <p>Add I16</p> </div> </div>

Saia Qronox ECS Engineering and Commissioning Suite

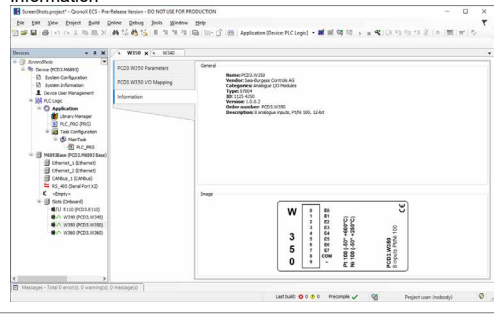
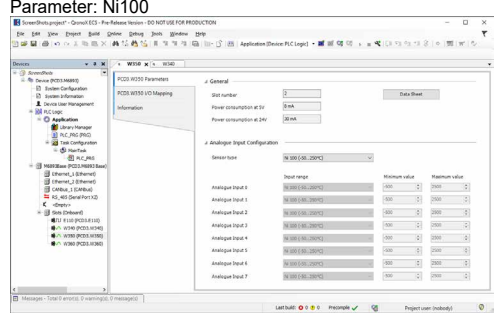
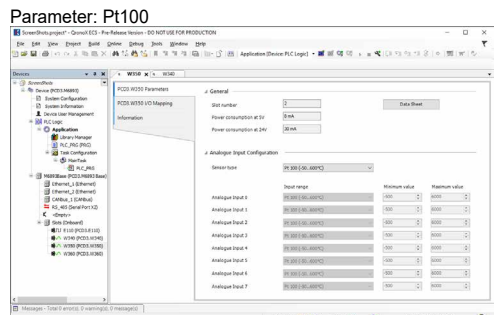
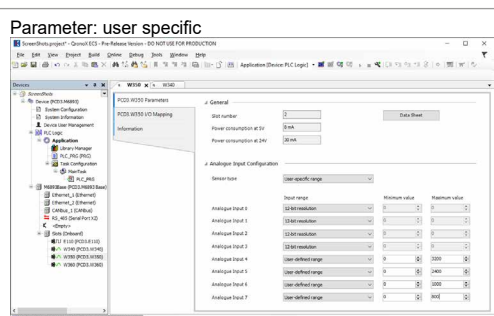
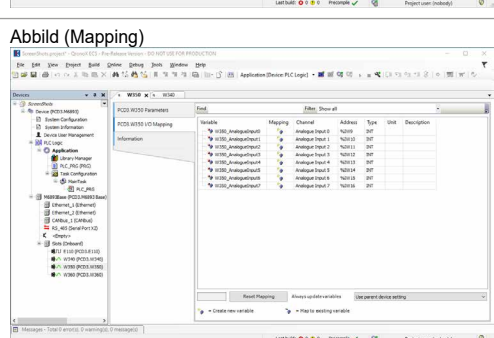
PCD-System	Evaluation
IEC-Controller	The evaluation is performed by the firmware. It reads the values according to the configuration (Device Configurator)
	<p>Information</p> 
	<p>Parameter: Ni100</p> 
	<p>Parameter: Pt100</p> 
	<p>Parameter: user specific</p> 
	<p>Abbild (Mapping)</p> 

Formulae for temperature measurement

Sensors

T = temperature in °C
 DV = digital value (0 ... 4095)

Ni 100

Validity: Temperature range - 50 ... + 250 °C
 Computational error: ± 1.65 °C

$$T = -28.7 + \frac{300 \cdot DV}{3628} - 7.294 \cdot 10^{-6} \cdot (DV - 1850)^2$$

Pt100

Validity: Temperature range - 50 ... + 600 °C
 Computational error: ± 1 °C

$$T = -99.9 + \frac{650 \cdot DV}{3910} + 6.625 \cdot 10^{-6} \cdot (DV - 2114)^2$$

**ATTENTION**

These devices must only be installed by a professional electrician, otherwise there is the risk of fire or the risk of an electric shock.

**WARNING**

Product is not intended to be used in safety critical applications, using it in safety critical applications is unsafe.

**WARNING - Safety**

The unit is not suitable for the explosion-proof areas and the areas of use excluded in EN 61010 Part 1.

**WARNING - Safety**

Check compliance with nominal voltage before commissioning the device (see type label).
Check that connection cables are free from damage and that, when wiring up the device, they are not connected to voltage.
Do not use a damaged device!

**NOTE**

In order to avoid moisture in the device due to condensate build-up, acclimatise the device at room temperature for about half an hour before connecting.

**CLEANING**

The device can be cleaned in dead state with a dry cloth or cloth soaked in soap solution.
Do not use caustic or solvent-containing substances for cleaning.

**MAINTENANCE**

These devices are maintenance-free. If damaged during, no repairs should be undertaken by the user.

**GUARANTEE**

Opening the module invalidates the guarantee.

Observe this instructions (data sheet) and keep them in a safe place.
Pass on the instructions (data sheet) to any future user.



WEEE Directive 2012/19/EC Waste Electrical and Electronic Equipment directive
The product should not be disposed of with other household waste. Check for the nearest authorized collection centers or authorized recyclers. The correct disposal of end-of-life equipment will help prevent potential negative consequences for the environment and human health.



EAC Mark of Conformity for Machinery Exports to Russia, Kazakhstan or Belarus.



PCD3.W350



4 405 4954 0

Ordering information

Type	Short description	Description	Weight
PCD3.W350	8 analogue inputs, 12 bit, Pt100 / Ni100	Analogue input module, 8 inputs (channels), resolution 12 bit, signal range Pt100 / Ni100, (the channels themselves not separated), connection with pluggable spring terminals, plug-in type A (4 405 4954 0) included	80 g

Ordering information equipment

Type	Short description	Description	Weight
4 405 4954 0	Plug-in, type A	Plug-in I/O spring terminal block, 10-pole up to 2.5 mm ² , labelled 0 ... 9	15 g

Saia-Burgess Controls AG
 Bahnhofstrasse 18 | 3280 Murten, Switzerland
 T +41 26 580 30 00 | F +41 26 580 34 99
 www.saia-pcd.com
 support@saia-pcd.com | www.sbc-support.com

Honeywell | Partner Channel