

# PCD3.W315

Analog input module, 7 channel, 12 bit, 0 ... 20 mA, electrically isolated from the CPU

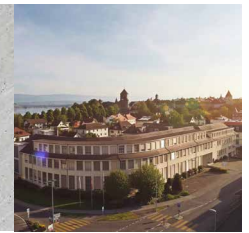

High-speed input modules for general use with 7 channels, each with 12 bit resolution and 0 ... 20 mA. Electrically isolated from the CPU.

Technical specifications	
Number of inputs (channels)	7
Signal range	0 ... 20 mA
Resolution (representation)	12 bit (0 ... 4095)
Resolution (value of least significant bit(LSB))	5 µA
Galvanic separation	500 V, electrical isolation of outputs to CPU, channels themselves not separated
Measuring principle	non-differential, single-ended
Input resistance	120 Ω / 0.1 %
Accuracy at 25 °C	± 0.15 %
Repeating accuracy (under same conditions)	± 0.05 %
Temperature error (0 ... +55 °C)	± 0.25 %
Conversion time A/D	≤ 2 ms
Overcurrent protection	± 35 mA (permanent)
EMV protection	yes
Time constant of input filter	typisch 2.4 ms
Internal current consumption (from +5 V bus)	< 60 mA
Internal current consumption (from V+ bus)	0 mA
External current consumption	0 mA
Terminals	Pluggable 10-pole spring terminal block for Ø up to 2.5 mm², plug type E (4 405 4998 0)



PCD3.W315

### Block schematic

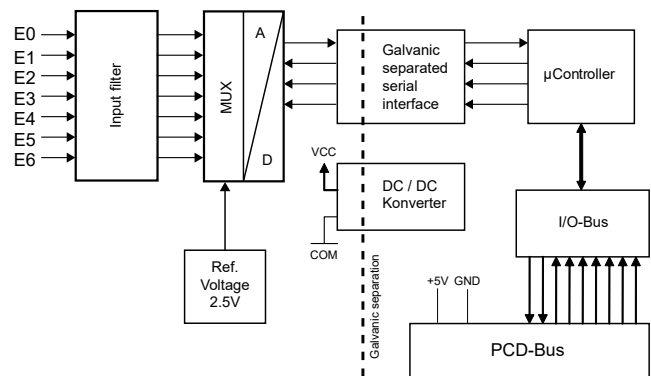

### Indicators and connections

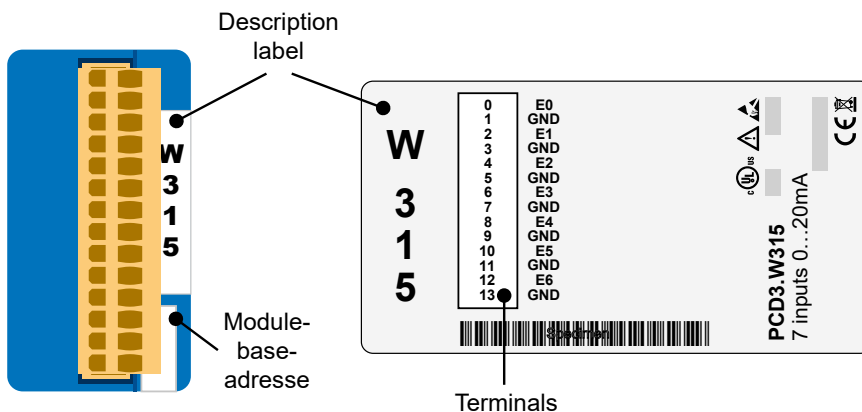



The GND connections are connected together in the module and are galvanically isolated from the CPU. These GNDs must not be connected to the CPU, process GNDs or ground !

## Connection concept for voltage inputs

The voltage input signals are connected directly to the 14-pole terminal block (E0 ... E6 and GND). To minimize the amount of interference coupled into the module via the transmission lines, connection should be made according to the principle explained below.

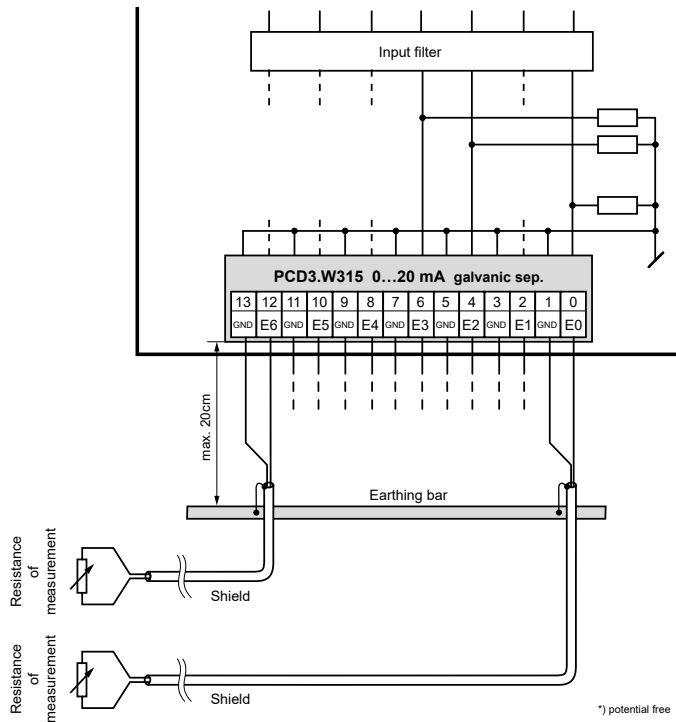
### Connection for 0...20 mA



-  The GND connections are connected together in the module and are galvanically isolated from the CPU. These GNDs must not be connected to the CPU, process GNDs or ground !
-  If shielded cables are used, the shielding should be connected to an earthing rail.

### Connection for 0...20 mA with two-wire transducers

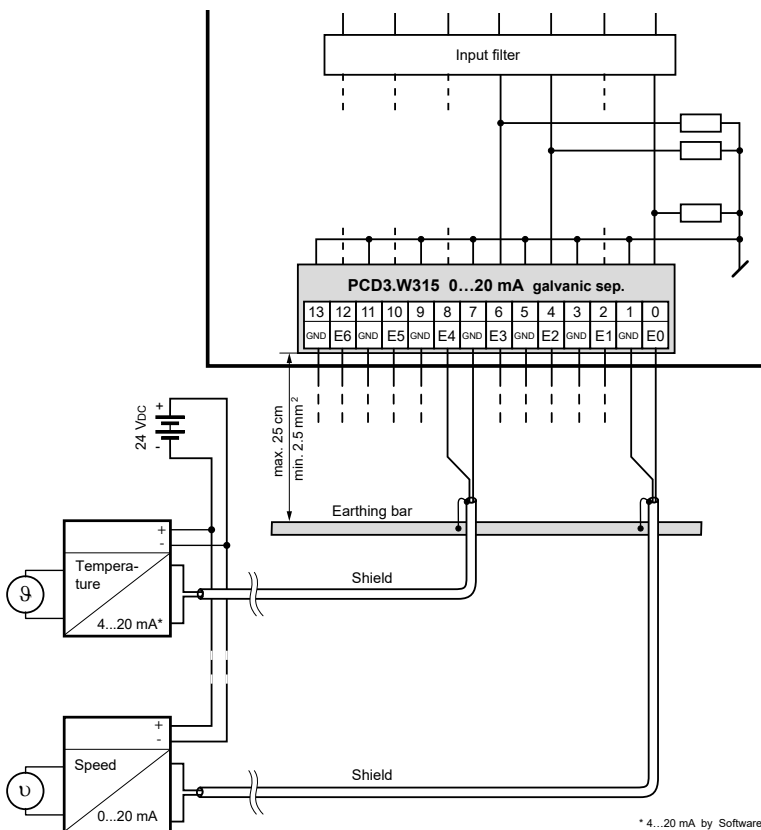

# Configuration

## Saia PCD® Classic

PCD-System	Evaluation
------------	------------

**Classic**  
The evaluation is performed by the firmware. It reads the values according to the configuration (Device Configurator or Network Configurator).

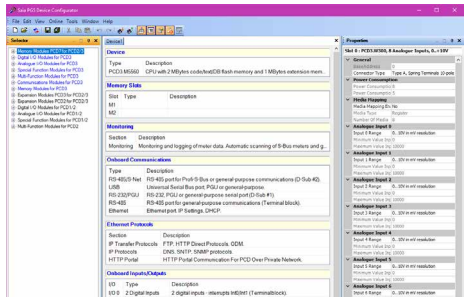

**Alternatively** An FBox "PCD2/3.W3x5" exists for evaluation.

FBox for PCD3.W315 (Inputs 0..7 selectable)

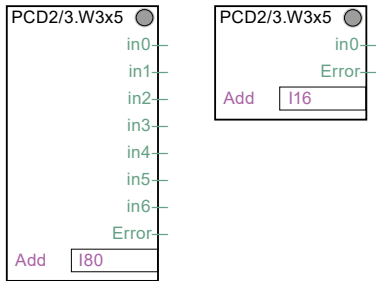

## Saia PCD® IEC-Controller

PCD-System	Evaluation
------------	------------

**IEC-Controller**  
The evaluation is performed by the firmware. It reads the values according to the configuration (Device Configurator)

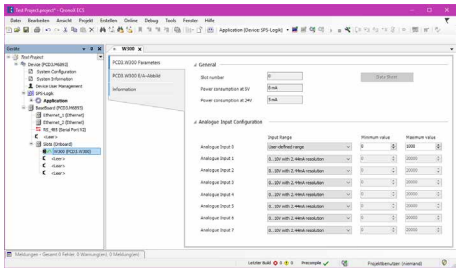



Galvanic separation of inputs to CPU, channels themselves not separated.



I/O modules and I/O terminal blocks may only be plugged in and removed when the CPU and the external +24 V are disconnected from the power supply.



**Further information**

This can be found in the Manual "27-600\_I/O-modules for PCD1 / PCD2 series and for PCD3".

**ATTENTION**

These devices must only be installed by a professional electrician, otherwise there is the risk of fire or the risk of an electric shock.

**WARNING**

Product is not intended to be used in safety critical applications, using it in safety critical applications is unsafe.

**WARNING - SAFETY**

The unit is not suitable for the explosion-proof areas and the areas of use excluded in EN 61010 Part 1.

**WARNING - SAFETY**

Check compliance with nominal voltage before commissioning the device (see type label). Check that connection cables are free from damage and that, when wiring up the device, they are not connected to voltage. Do not use a damaged device !

**NOTE**

In order to avoid moisture in the device due to condensate build-up, acclimatise the device at room temperature for about half an hour before connecting.

**CLEANING**

The device can be cleaned in dead state with a dry cloth or cloth soaked in soap solution. Do not use caustic or solvent-containing substances for cleaning.

**MAINTENANCE**

These devices are maintenance-free.  
If damaged during, no repairs should be undertaken by the user.

**GUARANTEE**

Opening the module invalidates the guarantee.



Observe this instructions (data sheet) and keep them in a safe place.  
Pass on the instructions (data sheet) to any future user.

**WEEE Directive 2012/19/EC Waste Electrical and Electronic Equipment directive**

The product should not be disposed of with other household waste. Check for the nearest authorized collection centers or authorized recyclers. The correct disposal of end-of-life equipment will help prevent potential negative consequences for the environment and human health.



EAC Mark of Conformity for Machinery Exports to Russia, Kazakhstan or Belarus.



PCD3.W315



4 405 4998 0

### Ordering information

Type	Short description	Description	Weight
PCD3.W315	7 analogue inputs, 0...20 mA, 12 bit, electrical isolation	Analog input module with electrical isolation, 7 channels (the channels are not isolated from each other), resolution 12 bit, range 0...20 mA, connection with pluggable spring terminals, connector type E (4 405 4998 0) supplied	100 g

### Ordering information equipment

Type	Short description	Description	Weight
4 405 4998 0	Plug-in, type E	Plug-in I/O spring terminal block, 14-pole up to 1.5 mm <sup>2</sup> , labelled 0 ... 13	13 g

Saia-Burgess Controls AG  
 Bahnhofstrasse 18 | 3280 Murten, Switzerland  
 T +41 26 580 30 00 | F +41 26 580 34 99  
 www.saia-pcd.com  
 support@saia-pcd.com | www.sbc-support.com

**Honeywell** | Partner Channel