



Q.NET-5TX and Q-NET-8TX

Industrial Ethernet Rail Switch



0	Content	
0.1	Document history	0-3
0.2	Trademarks	0-3
1	Safety instructions	
1.1	General safety instructions	1-1
1.2	Certified usage	1-1
1.3	Installation site requirements	1-1
1.4	Device casing	1-1
1.5	Qualification requirements for personnel	1-2
1.6	National and international safety regulations	1-2
1.7	Grounding the device	1-2
1.8	Shielding ground	1-2
1.9	Requirements for connecting electrical wires	1-3
1.10	Supply voltage	1-4
1.11	CE marking	1-4
1.12	FCC note	1-5
1.13	Recycling note	1-5
2	Description	
2.1	General device description	2-1
2.2	Device name and product code	2-1
2.3	Device view	2-2
2.3.1	Q.NET-5TX	2-2
2.3.2	Q.NET-8TX	2-3
2.4	Power supply	2-3
2.5	Ethernet ports	2-4
2.5.1	10/100 Mbit/s twisted pair port	2-4
2.6	Pin assignments	2-4
2.7	Display elements	2-5
2.7.1	Device state	2-5
2.7.2	Port state	2-6
3	Installation	
3.1	Checking the package contents	3-1
3.2	Mounting the device	3-2
3.2.1	Installing the device onto the DIN rail	3-2
3.3	Wiring the terminal block for the supply voltage and the grounding	3-3
3.5	Operating the device	3-4
3.6	Connecting data cables	3-4
4	Monitoring the ambient air temperature	
5	Maintenance and service	

6	Disassembly	
6.1	Removing the device	6-1
7	Technical data	
7.1	General technical data	7-1
7.2	Dimension drawings	7-2
7.2.1	Q.NET-5TX	7-2
7.2.2	Q.NET-8TX	7-2
7.3	EMC and immunity	7-3
7.4	Network range	7-3
7.5	Power consumption/power output at 24 V DC	7-4
7.6	Scope of delivery	7-4
7.7	Underlying technical standards	7-4
A	Appendix	
A.1	Icons	A-1
A.2	Contact	A-2

0.1 Document history

0

Version	Published	Chapter	Remarks
ENG01	2019-08-14	all	First edition

0.2 Trademarks

Saia PCD[®] is a registered trademark of Saia-Burgess Controls AG.

Subject to technical changes in line with the latest technological developments.

Saia-Burgess Controls AG, 2019. © All rights reserved.

Published in Switzerland

1 Safety instructions

1.1 General safety instructions

1

You operate this device with electricity. Improper usage of the device entails the risk of physical injury or significant property damage. The proper and safe operation of this device depends on proper handling during transportation, proper storage and installation, and careful operation and maintenance procedures.

- Before connecting any cable, read this document, and the safety instructions and warnings.
- Operate the device with undamaged components exclusively.
- The device is free of any service components. In case of a damaged or malfunctioning the device, turn off the supply voltage and return the device to Hirschmann for inspection.

1.2 Certified usage

- Use the product only for the application cases described in the Hirschmann product information, including this manual.
- Operate the product only according to the technical specifications. See „7 Technical data“ auf Seite 7-1
- Connect to the product only components suitable for the requirements of the specific application case.

1.3 Installation site requirements

- Install the device in a fire enclosure according to EN 60950-1.

1.4 Device casing

Only technicians authorized by the manufacturer are permitted to open the casing.

- Never insert pointed objects (narrow screwdrivers, wires, etc.) into the device or into the connection terminals for electric conductors. Do not touch the connection terminals.
- Keep the ventilation slits free to ensure good air circulation. See „7.1 General technical data“ auf Seite 7-1.
- Install the device in the vertical position.

1.5 Qualification requirements for personnel

- Only allow qualified personnel to work on the device.

Qualified personnel have the following characteristics:

- ▶ Qualified personnel are properly trained. Training as well as practical knowledge and experience make up their qualifications. This is the prerequisite for grounding and labeling circuits, devices, and systems in accordance with current standards in safety technology.
- ▶ Qualified personnel are aware of the dangers that exist in their work.
- ▶ Qualified personnel are familiar with appropriate measures against these hazards in order to reduce the risk for themselves and others.
- ▶ Qualified personnel receive training on a regular basis.

1.6 National and international safety regulations

Verify that the electrical installation meets local or nationally applicable safety regulations.

1.7 Grounding the device

The device is grounded by means of a 3-pin terminal block.

- Use a wire diameter for the ground conductor that is no smaller than the diameter of the supply voltage connection, however of at least 0.5 mm² (AWG20).

1.8 Shielding ground

The shielding ground of the connectable twisted pair cables is connected to the ground connection as a conductor.

- Beware of possible short circuits when connecting a cable section with conductive shielding braiding.

1.9 Requirements for connecting electrical wires

Before connecting the electrical wires, **always** verify that the requirements listed are complied with.

1

General requirements for connecting electrical wires
The following requirements apply without restrictions:
<ul style="list-style-type: none"> ▶ The electrical wires are voltage-free. ▶ The cables used are permitted for the temperature range of the application case. ▶ The voltage connected complies with the requirements for a safety extra-low voltage (SELV) as per IEC/EN 60950-1. ▶ Relevant for North America: Use 60/75 or 75 °C copper (Cu) wire only.

Requirements for connecting the supply voltage	
The following requirements apply without restrictions:	
<ul style="list-style-type: none"> ▶ The supply voltage corresponds to the voltage specified on the type plate of the device. ▶ The power supply conforms to overvoltage category I or II. ▶ The power supply has an easily accessible disconnecting device (e.g., a switch or a plug). This disconnecting device is clearly identified. So in the case of an emergency, it is clear which disconnecting device belongs to which power supply cable. ▶ The power supply cable is suitable for the voltage, the current and the physical load. SBC recommends a wire diameter of 0.5 mm² (AWG20). ▶ The cross-section of the ground conductor is the same size as or bigger than the cross-section of the power supply cables. 	
The following requirements apply alternatively:	
Alternative 1	The power supply complies with the requirements for a limited power source (LPS) as per EN 60950-1.
Alternative 2	<p>Alle folgenden Voraussetzungen sind erfüllt:</p> <ul style="list-style-type: none"> ▶ The power supply complies with the requirements for a safety extra-low voltage (SELV) as per IEC/EN 60950-1. ▶ A fuse suitable for DC voltage is located in the plus conductor of the power supply. The minus conductor is on ground potential. Otherwise, a fuse is also located in the minus conductor. Regarding the properties of this fuse: See „7.1 General technical data“ auf Seite 7-1.
Alternative 3	Relevant for North America: The power supply complies with the requirements as per NEC Class 2

1.10 Supply voltage

The supply voltage is only connected with the ground connection via protective elements.

1

1.11 CE marking

The labeled devices comply with the regulations contained in the following European directive(s):

- 2011/65/EU (RoHS)
Directive of the European Parliament and of the Council on the restriction of the use of certain hazardous substances in electrical and electronic equipment.
- 2014/30/EU (EMC)
Directive of the European Parliament and the council for standardizing the regulations of member states with regard to electromagnetic compatibility.

In accordance with the above-named EU directive(s), the EU conformity declaration will be available to the relevant authorities at the following address:

Hirschmann Automation and Control GmbH
Stuttgarter Str. 45-51
72654 Neckartenzlingen
Deutschland
Tel.: +49 1805 141538

The device can be used in the industrial sector.

- ▶ Interference immunity: EN 61000-6-2
- ▶ Emitted interference: EN 55022

You find more information on technical standards here:

„7 Technical data“ auf Seite 7-1

The assembly guidelines provided in these instructions must be strictly adhered to in order to observe the EMC threshold values.



Warning! This is a class A device. This device can cause interference in living areas, and in this case the operator may be required to take appropriate measures.

1.12 FCC note

This device complies with part 15 of the FCC rules. Operation is subject to the following two conditions: (1) this device may not cause harmful interference; (2) this device must accept any interference received, including interference that may cause undesired operation.

1

Appropriate testing has established that this device fulfills the requirements of a class A digital device in line with part 15 of the FCC regulations.

These requirements are designed to provide sufficient protection against interference when the device is being used in a business environment.

The device creates and uses high frequencies and can also radiate these frequencies. If it is not installed and used in accordance with this operating manual, it can cause radio transmission interference. The use of this device in a residential area can also cause interference, and in this case the user is obliged to cover the costs of removing the interference.

1.13 Recycling note

After usage, this device must be disposed of properly as electronic waste, in accordance with the current disposal regulations of your county, state, and country.

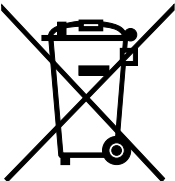

WEEE Directive:

At the end of their useful life the packaging and product should be disposed of by a suitable recycling centre.

Do not dispose of with normal household waste.
Do not burn.

2 Description

2.1 General device description

The SPIDER-SL devices are designed for the special requirements of industrial automation. They meet the relevant industry standards, provide very high operational reliability, even under extreme conditions, and also long-term reliability and flexibility.

2

You have numerous options of combining the device characteristics.

2.2 Device name and product code

The device name corresponds to the product code. The product code is made up of characteristics with defined positions. The characteristic values stand for specific product properties.

Code	Characteristic value	Description
Q.NET	Produktreihe	Industrial Ethernet Rail Switch Data rate 10/100 Mbit/s without PoE support
xTX	Number of Twisted pair ports	x = 5 or 8

Table 1: Device name and product code

2.3 Device view

2.3.1 Q.NET-5TX

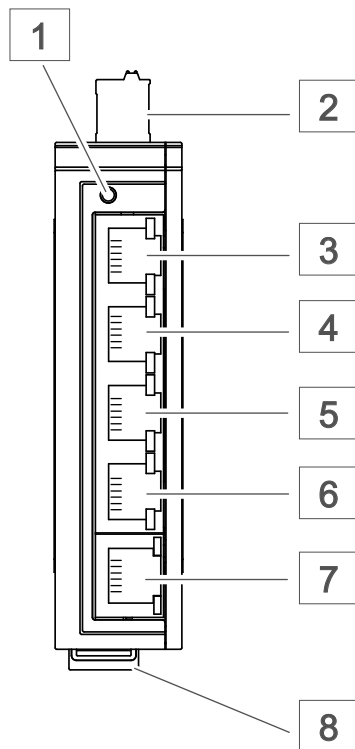

2

1	LED display elements for device status
2	3-pin, pluggable terminal block for power supply
3 ... 7	5 × RJ45 socket for 10/100/1000 Mbit/s Twisted Pair connections
8	Rail lock gate for DIN rail mounting

2.3.2 Q.NET-8TX

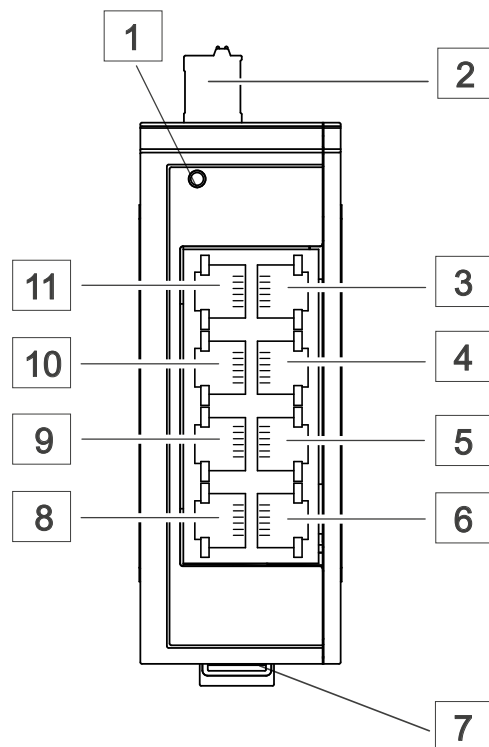

2

1	LED display elements for device status
2	3-pin, pluggable terminal block for power supply
3 ... 6	4 × RJ45 socket for 10/100 Mbit/s twisted pair connections
7	Rail lock gate for DIN rail mounting
8 ... 11	4 × RJ45 socket for 10/100 Mbit/s twisted pair connections

2.4 Power supply

You have the following options to supply your device with voltage:

■ Power supply via a 3-pin terminal block

For the power supply of the device, a 3-pin terminal block is available.

For further information see „3.3 Wiring the terminal block for the supply voltage and the grounding“ auf Seite 3-3.

2.5 Ethernet ports

2.5.1 10/100 Mbit/s twisted pair port

This port is an RJ45 socket.

The 10/100 Mbit/s twisted pair port offers you the ability to connect network components according to the IEEE 802.3 10BASE-T/100BASE-TX standard.



This port supports:

- ▶ Autonegotiation
- ▶ Autopolarity
- ▶ Autocrossing
- ▶ 100 Mbit/s half-duplex mode, 100 Mbit/s full duplex mode
- ▶ 10 Mbit/s half-duplex mode, 10 Mbit/s full duplex mode

2.6 Pin assignments

RJ45	Pin	10/100 Mbit/s
	MDI mode	
	1	TX+
	2	TX-
	3	RX+
	4	—
	5	—
	6	RX-
	7	—
8	—	
	MDI-X mode	
	1	RX+
	2	RX-
	3	TX+
	4	—
	5	—
	6	TX-
	7	—
8	—	

2.7 Display elements

After the supply voltage is switched on, the device performs a self-test.

During this process, various LEDs light up.

2

2.7.1 Device state

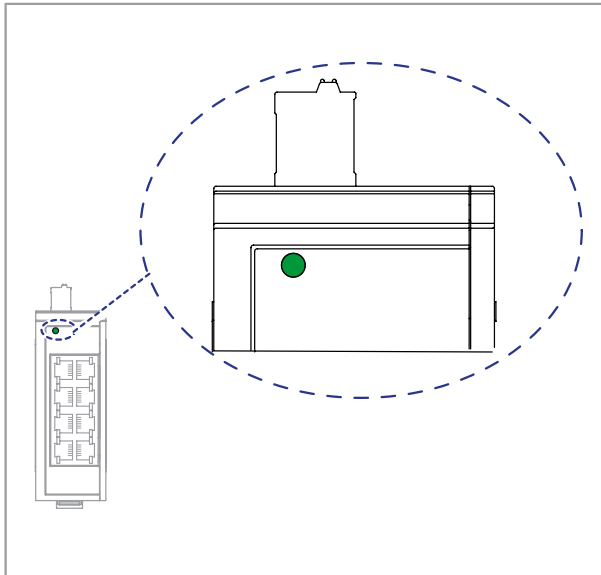

This LED provides information on the status of the power supply.

Color	Activity	Meaning
Green	Lights up	Supply voltage is on Device is ready for operation
	None	Supply voltage is too low Device is not ready for operation

2.7.2 Port state

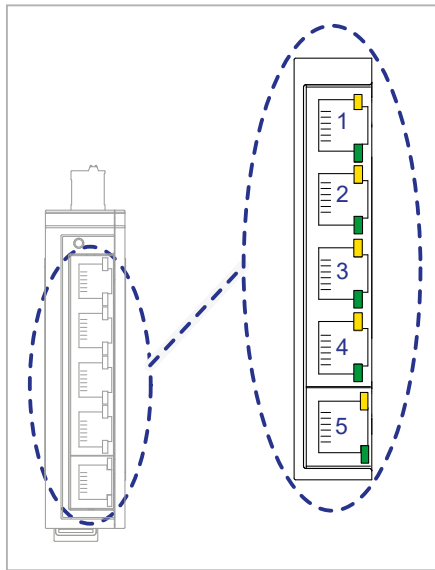

These LEDs provide port-related information.

LS/DA (link status/data)	Color	Activity	Meaning
	Green	Lights up	Device detects a valid link
		Flashing	Device is transmitting and/or receiving data
		None	Device detects an invalid or missing link

SP (data rate)	Color	Activity	Meaning
	Yellow	Flashes 1 time a period	10 Mbit/s connection
		Flashes 2 times a period	100 Mbit/s connection
		Flashes 3 times a period	1000 Mbit/s connection

100 Mbit/s	Color	Activity	Meaning
	Yellow	Lights up	100 Mbit/s connection
		None	Device detects an invalid or missing link

3 Installation

The devices have been developed for practical application in a harsh industrial environment.

On delivery, the device is ready for operation.

To configure a subdomain, follow these steps:

- ▶ Checking the package contents
- ▶ Mounting the device
- ▶ Wiring the terminal block for the supply voltage and the grounding
- ▶ Operating the device
- ▶ Connecting data cables

3

3.1 Checking the package contents

- Check whether the package includes all items named in the section „7.6 Scope of delivery“ auf Seite 7-4.
- Check the individual parts for transport damage.

3.2 Mounting the device

You have the following options for mounting your device:

- ▶ Installing the device onto the DIN rail
- ▶ Mounting on a flat surface

3.2.1 Installing the device onto the DIN rail

3

Prerequisite:

The device is for mounting on a 35 mm DIN rail in accordance with DIN EN60715.

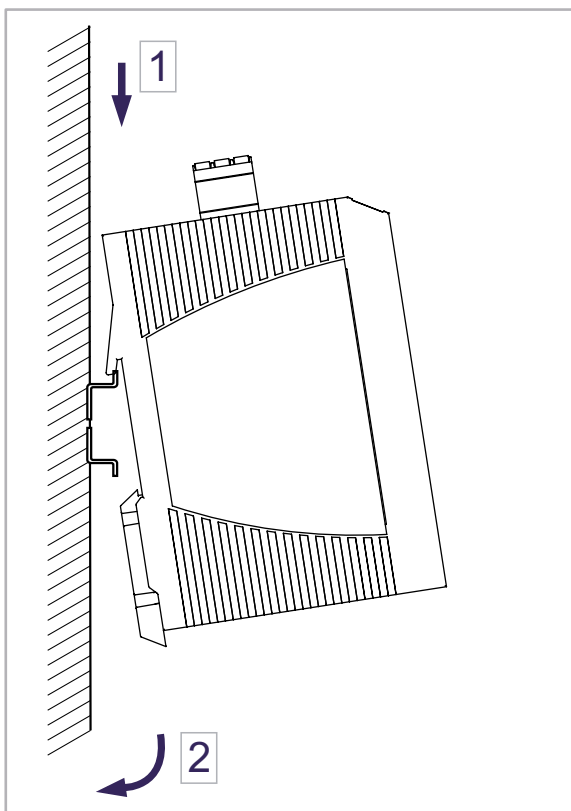

Proceed as follows:

- Slide the upper snap-in guide of the device into the DIN rail.
- Use a screwdriver to pull the rail lock gate downwards.
- Snap in the device by releasing the rail lock slide.

3.3 Wiring the terminal block for the supply voltage and the grounding

	WARNING
<p>ELECTRIC SHOCK</p> <p>Connect only a supply voltage that corresponds to the type plate of your device.</p> <p>Never insert sharp objects (small screwdrivers, wires, etc.) into the connection terminals for the supply voltage, and do not touch the terminals.</p> <p>Failure to follow these instructions can result in death, serious injury, or equipment damage.</p>	

3

A 3-pin terminal block is used for the grounding and for connecting the supply voltage.

The supply voltage is only connected with the ground connection via protective elements.

The shielding ground of the connectable twisted pair cables is connected to the ground connection as a conductor.

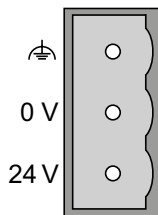

Figure 1: 3-pin, pluggable terminal block for power supply and grounding

Type of the voltages that can be connected	Specification of the supply voltage	Connections	
Gleichspannung	Nennspannungsbereich DC 12 V ... 24 V	24 V Pluspol der Versorgungsspannung	
	Spannungsbereich DC inklusive maximaler Toleranzen 9,6 V ... 32 V	0 V Minuspol der Versorgungsspannung	
			Funktions- erdeanschluss

Table 2: Type and specification of the supply voltage and pin assignment on the device

Proceed as follows:

- Ensure the required conditions for connecting the supply voltage.
See „Requirements for connecting the supply voltage“ auf Seite 1-3.
- Pull the terminal block off the device.
- Connect the ground connection.
- Connect the power supply cables.
- Plug the terminal block into the connection on the housing.

3.5 Operating the device

By connecting the supply voltage via the terminal block, you start the operation of the device.

3.6 Connecting data cables

3

Note the following general recommendations for data cable connections in environments with high electrical interference levels:

- ▶ Keep the length of the data cables as short as possible.
- ▶ Use optical data cables for the data transmission between the buildings.
- ▶ When using copper cables, provide a sufficient separation between the power supply cables and the data cables. Ideally, install the cables in separate cable channels.
- ▶ Verify that power supply cables and data cables do not run parallel over longer distances, and that ideally they are installed in separate cable channels. If reducing the inductive coupling is necessary, verify that the power supply cables and data cables cross at a 90° angle.
- ▶ Use shielded cables (SF/UTP cables as per ISO/IEC 11801:2002).
- ▶ Beware of possible short circuits when connecting a cable section with conductive shielding braiding.
- Connect the data cables according to your requirements.

4 Monitoring the ambient air temperature

Operate the device below the specified maximum ambient air temperature exclusively.

See „7.1 General technical data“ auf Seite 7-1.

The ambient air temperature is the temperature of the air at a distance of 2 in (5 cm) from the device. It depends on the installation conditions of the device, e.g. the distance from other devices or other objects, and the output of neighboring devices.

5 Maintenance and service

When designing this device, Hirschmann largely avoided using high-wear parts. The parts subject to wear and tear are dimensioned to last longer than the lifetime of the product when it is operated normally. Operate this device according to the specifications.

Depending on the degree of pollution in the operating environment, check at regular intervals that the ventilation slots in the device are not obstructed.

	CAUTION
RISK OF TRANSIENTS OR ELECTROSTATIC DISCHARGES	
Do not open the housing.	
Failure to follow these instructions can result in injury or equipment damage.	

5



Note! You will find information about the complaints and returns procedures on the Internet under:

<https://www.sbc-support.com/en/services/repair-service/>

6 Disassembly

6.1 Removing the device

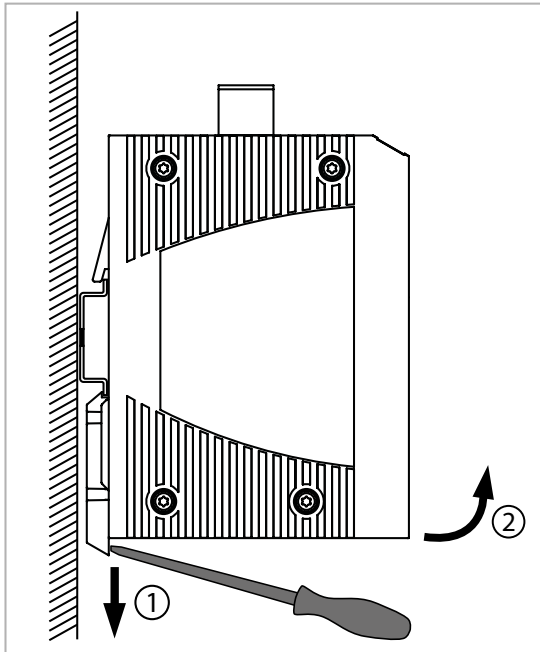

6

Proceed as follows:

- Disconnect the data cables.
- Disable the supply voltage.
- Remove the power connector from the device.
- Use a screwdriver to pull the rail lock gate downwards.
- Pull the device downwards from the DIN rail module.

7 Technical data

7.1 General technical data

	Characteristic values	Description
Dimensions W × H × D	See „7.2 Dimension drawings“ auf Seite 7-2.	
Power supply	<ul style="list-style-type: none"> ▶ 1 voltage input ▶ 3-pin terminal block ▶ Safety extra-low voltage (SELV) 	
	Rated voltage range DC	12 V ... 24 V Class 2
	Voltage range DC incl. maximum tolerances	9,6 V ... 32 V
	Power loss buffer	10 ms at 20,4 V DC
	Back-up fuse	≤ 4 A, slow blow
	Peak inrush current	4 A
Potential difference between input voltage and ground connection	Potential difference from incoming voltage+24 V DC	+32 V DC
	Potential difference from incoming voltage, ground	-32 V DC
Climatic conditions during operation	Ambient air temperature ^a	0 °C ... +60 °C Derating
	Humidity	10 % ... 95 % (non-condensing)
	Air pressure	minimum 795 hPa (+6562 ft; +2000 m)
Climatic conditions during storage	Ambient air temperature ^a	-40 °C ... +70 °C
	Humidity	10 % ... 95 % (non-condensing)
	Air pressure	minimum 700 hPa (+9842 ft; +3000 m)
Pollution degree		2
Protection classes	Degree of protection	IP 30
a. Temperature of the ambient air at a distance of 2 inches (5 cm) from the device		

7.2 Dimension drawings

7.2.1 Q.NET-5TX

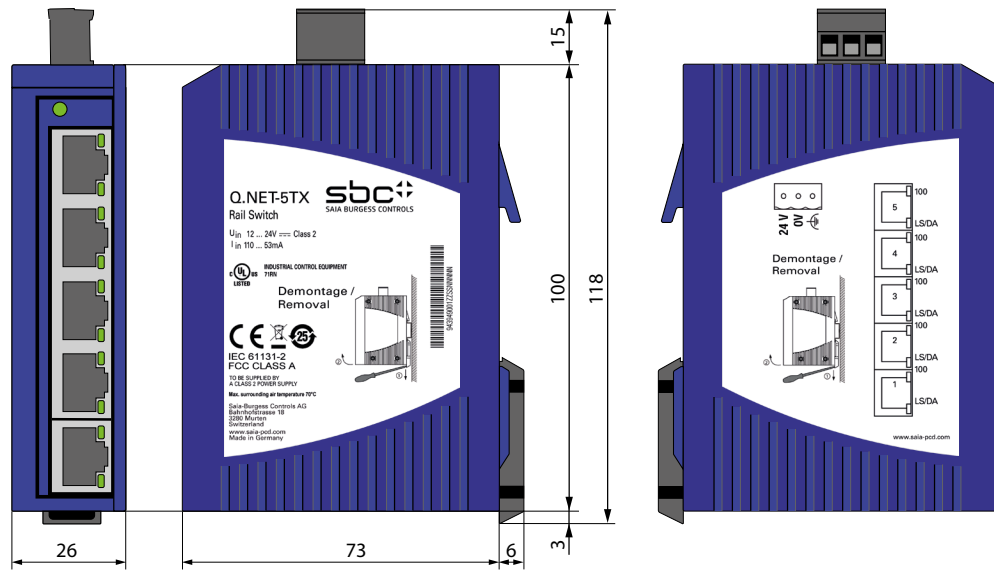

7.2.2 Q.NET-8TX

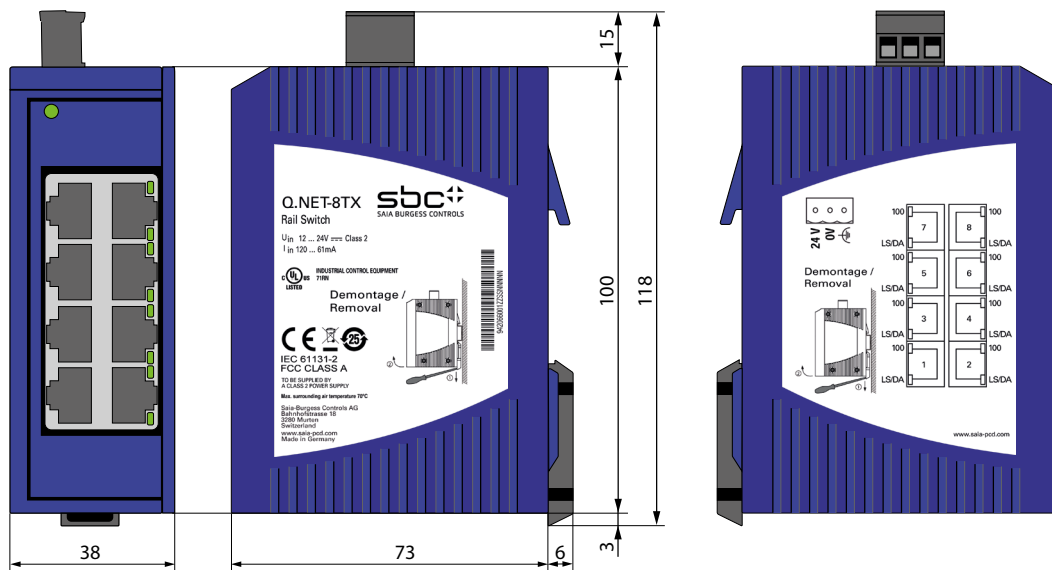

7.3 EMC and immunity

EMC interference emission	
Radiated emission	
FCC 47 CFR Part 15	Class A
EN 55022	Class A
Conducted emission	
FCC 47 CFR Part 15	Class A
EN 55022	Class A

EMC interference immunity		
Electrostatic discharge		
EN 61000-4-2 IEEE C37.90.3	Contact discharge	± 4 kV
EN 61000-4-2 IEEE C37.90.3	Air discharge	± 8 kV
Electromagnetic field		
EN 61000-4-3	80 MHz ... 1000 MHz	10 V/m
Fast transients (burst)		
EN 61000-4-4 IEEE C37.90.1	DC supply connection	2 kV
EN 61000-4-4 IEEE C37.90.1	Data line	4 kV
Voltage surges - DC supply connection		
EN 61000-4-5	line/ground	2 kV
EN 61000-4-5	line/line	1 kV
Voltage surges - data line		
EN 61000-4-5	line/ground	1 kV
Conducted disturbances		
EN 61000-4-6	150 kHz ... 80 MHz	10 V

Stability		
IEC 60068-2-6, test Fc	Vibration	5 Hz ... 8,4 Hz with 3.5 mm amplitude
		8,4 Hz ... 150 Hz with 1 g
IEC 60068-2-27, test Ea	Shock	15 g at 11 ms

7.4 Network range

10/100 Mbit/s twisted pair port	
Length of a twisted pair segment	max. 109 yards (100 m) (for Cat5e cable)

7.5 Power consumption/power output at 24 V DC

Device name	Max. power consumption	Power output
Q.NET-5TX	2,0 W	7,0 BTU(IT)/h
Q.NET-8TX	1,5 W	5,3 BTU(IT)/h

7.6 Scope of delivery

Number	Article
1 ×	Device
1 ×	3-pin, pluggable terminal block for power supply
1 ×	General safety instructions PP26-061

7.7 Underlying technical standards

Name	Description
CSA C22.2 No. 142	Canadian National Standard(s) – Process Control Equipment – Industrial Products
EN 55022	Information technology equipment – Radio disturbance characteristics – Limits and methods of measurement
EN 60950-1	Information technology equipment – Safety – Part 1: General requirements
EN 61000-6-2	Electromagnetic compatibility (EMC) – Part 6-2: Generic standards – Immunity for industrial environments
EN 61131-2	Programmable controllers – Part 2: Equipment requirements and tests
FCC 47 CFR Part 15	Code of Federal Regulations
UL/IEC 61010-1, UL/IEC 61010-2-201	Safety for Control Equipment

Table. 3: List of the technical standards

The device has an approval based on a specific standard only if the approval indicator appears on the device casing.

The device generally fulfills the technical standards named in their current versions.

A Appendix

A.1 Icons



In operating instructions, this symbol points the reader to further information in these instructions, in other instructions or in technical documents. No direct link to these documents is given.



Instructions with this symbol must always be followed.



This symbol warns the reader of the risk to components from electrostatic discharges caused by touch.

Recommendation: Before coming into contact with electrical components, you should at least touch the Minus of the system (cabinet of PGU connector). It is better to use a grounding wrist strap with its cable permanently attached to the Minus of the system.



Explanations beside this sign are valid only for the Saia PCD® Classic series.



Explanations beside this sign are valid only for the Saia PCD® xx7 series.

A.2 Contact

Saia-Burgess Controls AG

Bahnhofstrasse 18
3280 Murten, Switzerland

Telefon +41 26 580 30 00

Fax +41 26 580 34 99

Email Support: support@saia-pcd.com

Supportsite: www.sbc-support.com

SBC site: www.saia-pcd.com

International Representatives &

SBC Sales Companies: www.saia-pcd.com/contact

Postal address for returns from customers of the Swiss Sales office

Saia-Burgess Controls AG

Service Après-Vente
Bahnhofstrasse 18
3280 Murten, Switzerland

