



PCD3 Compact

0	Content	
0.1	Document History	0-3
0.2	Brands and trademarks	0-3
1	Orientation guide	
1.1	Introduction	1-1
1.2	Instructions for connecting Saia-PCD® controllers to the internet.....	1-1
1.3	Planning an application.....	1-2
1.4	I/O Extension	1-3
1.5	Mounting rules	1-4
1.5.1	Airflow	1-4
1.5.2	Mounting	1-4
1.5.3	Earthing and connection plan	1-4
1.6	General technical details.....	1-6
2	PCD3.M2x30 Compact CPUs	
2.1	Introduction	2-1
2.2	General Overview	2-1
2.2.1	Characteristics	2-2
2.3	Connections of the CPU	2-3
2.4	Description of the LEDs	2-4
2.5	Dimensions	2-5
2.6	I/O Connections	2-6
2.6.1	Analogue Inputs (Part of Terminal block X0).....	2-7
2.6.2	Analogue Outputs (Part of Terminal block X0).....	2-8
2.6.3	Digital Inputs (Terminal block 1,2 and part of 4).....	2-9
2.6.4	Digital Outputs (Terminal block 3 and part of 4).....	2-10
2.6.5	Terminal block with “Push In” system and LEDs (optional).....	2-10
3	Communication interfaces	
3.1	Ethernet	3-1
3.2	USB.....	3-1
3.3	Onboard Serial ports.....	3-1
3.4	Communication ports with socket A.....	3-1
4	Input/output (I/O) modules	

5	Configuration	
5.1	General	5-1
5.2	Hardware configuration-Device Configurator	5-2
5.3	Digital inputs properties	5-3
5.3.1	General	5-3
5.3.2	Standard inputs	5-4
5.3.3	Counters with enable input	5-5
5.3.4	Encoders with A, B and index signal	5-10
5.3.5	Interrupts.....	5-15
5.4	Digital outputs properties	5-17
5.5	Analogue inputs properties	5-18
5.6	Analogue outputs properties	5-20
5.7	General remarks	5-21
5.8	Firmware update	5-22
6	Maintenance	
6.1	Changing the battery.....	6-1
A	Appendix	
A.1	Icons	A-1
A.2	Definitions of serial interfaces	A-2
A.2.1	RS-232.....	A-2
A.2.2	RS-485/422.....	A-3
A.3	Order details	A-4
A.4	Contact	A-5

0.1 Document History

Date	Version	Changes	Remarks
pEN01	2009-02-15	-	New edition
EN02	2009-03-15	2009-07-10	different modifications
EN03	2010-09-02	-	Definition of the ambient temperature for the PCD7.F150
EN04	2011-04-15	2011-04-18	New phone number Timing of the digital inputs
EN05	2014-04-09	-	Change of Logo
ENG06	2017-03-07	2017-03-07	- just 2, not 4 analogue outputs - new phone number

0.2 Brands and trademarks

Saia PCD® and Saia PG5®
are registered trademarks of Saia-Burgess Controls AG.

Technical modifications are based on the current state-of-the-art technology.

Saia-Burgess Controls AG, 2017 © All rights reserved.

Published in Switzerland

1 Orientation guide

1.1 Introduction

1

This manual covers the technical aspects of the PCD3.M2x30V6. The following terms are used frequently:

- CPU Central processing unit: the heart of the SaiaPCD®
- LIOs Local I/Os: these are connected to the CPU via the I/O bus
- Modules Input/output elements, mounted in a housing, matched to the PCD3 system
- Module holder CPU or LIO, to which modules may be attached

The aim of this section is to present the essentials of planning and installing control systems with PCD3 components.

1.2 Instructions for connecting Saia-PCD® controllers to the internet



When Saia PCD controllers are connected directly to the internet, they are also a potential target of cyber attacks. For secure operation, appropriate protective measures must always be taken.

PCD controllers include simple, built-in protection features. However, secure operation on the internet is only ensured if external routers are used with a firewall and encrypted VPN connections.

For more information, please refer to our support site:

www.sbc-support.com/security

1.3 Planning an application

The following aspects should be considered when planning PCD3 applications:

- It's only **one** module holder allowed
 - PCD3.C200 or PCD3.C110 (Connection with cable PCD3.K106/K116)
 - PCD3.C200Z09 or PCD3.C110Z09 (Connection with connector PCD3.K010)
- The internal load current taken by the I/O modules from the +5V and V+ supply must not exceed the maximum supply current specified for the CPUs or the LIO PCD3.C110/C110Z09

1

When planning an application, we recommend the following procedure:

Select the I/O modules according to your requirements. Where possible, use PCD3 I/O modules with 16 connections; these have 16 red LEDs

PCD3	M2030V6	M2130V6
I/O bus connection for expansion units	Yes	
Number of inputs/outputs with the one I/O module holder (PCD3.C200)	102 ¹⁾	

1) Using digital I/O modules PCD3.E16x or A46x with 16 I/Os each

1.4 I/O Extension

Only **one** extension PCD3.C200 or PCD3.C110 can be connected!

1

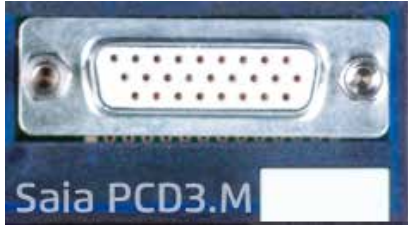

The additional I/Os can be mapped with the device configurator.

The first I/O address on the extension module is 64.

No SPI communication on the extension.

With Profi-S-Net on port 2 or Ethernet the System can also be extended with PCD3.RIO (PCD3.T760 or PCD3.T660) modules.

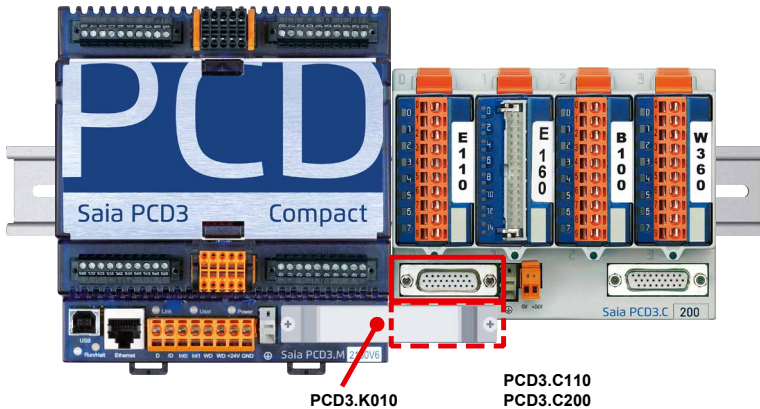

For connecting the former extension modules to the Saia PCD®, use the following cables:

PCD3.K106, 0.7 m

PCD3.K116, 1.2 m

With the new extension modules PCD3.C110Z09 and PCD3.C200Z09 the connector PCD3.K010 can be used.

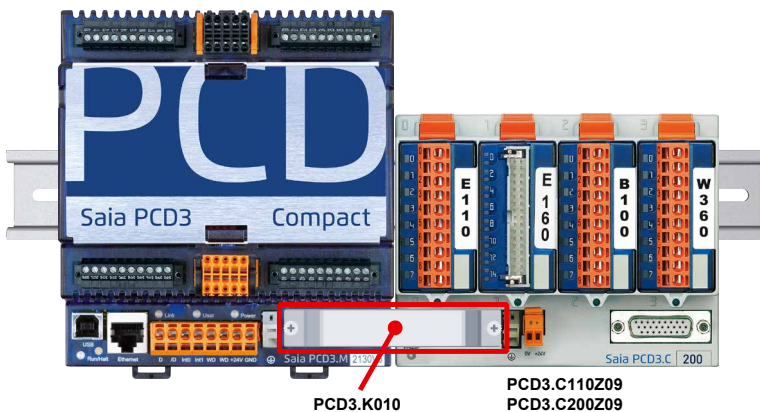

In the bottom part of the PCD3.WAC there is a shielding and earthing plate.

The zero-potential (Minus pole) of the 24 V supply is connected to the Minus terminal of the supply. This should be connected to the earthing bar with the shortest possible wire (< 25 cm) of 1.5 mm².

Any shielding of analogue signals or communication cables should also be brought to

1.5 Mounting rules

1.5.1 Airflow

1

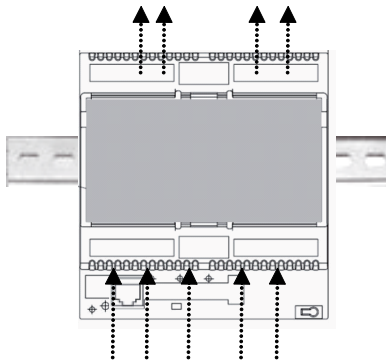

The controller must be mounted in a vertical way so that cooling is given by thermic air flow from down to the upper side of the shape.

1.5.2 Mounting

The PCD3.WAC will be mounted on a 35 mm top hat rail DIN EN60715.

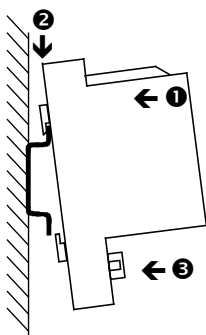

Mounting:

- ❶ Press the top of the housing onto the mounting surface
- ❷ Press downwards against the top hat rail
- ❸ Press the bottom of the housing against the mounting surface and snap into place.

Remove:

Push downwards the two holding elements and pull out.

1.5.3 Earthing and connection plan

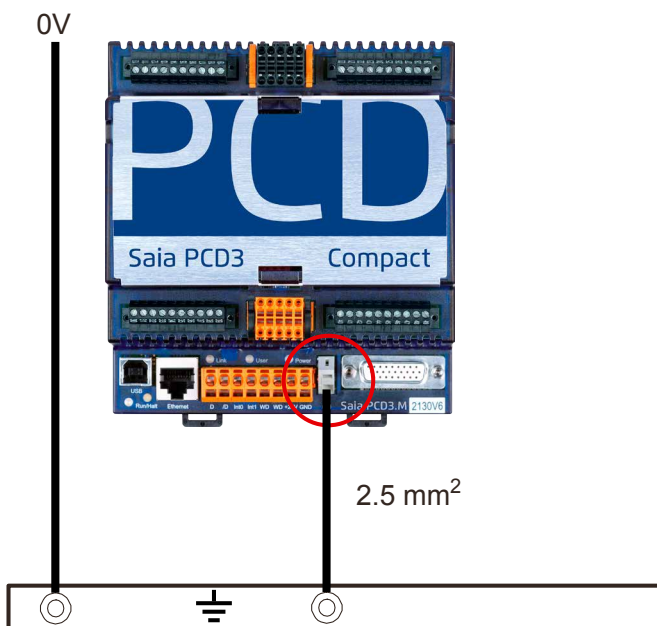

In the bottom part of the PCD3.Compact there is a shielding and earthing plate.

The zero-potential (Minus pole) of the 24 V supply is connected to the Minus terminal of the supply. This should be connected to the earthing bar with the shortest possible wire (< 25 cm) of 1.5 mm².

1

Any shielding of analogue signals or communication cables should also be brought to the same earth potential, either via a Minus terminal or via the earthing bar.

All Minus connections are linked internally. For problem-free operation, these connections should be reinforced externally with short wires of 1.5 mm².

1.6 General technical details

Supply (external and internal)	
Supply voltage	24 VDC \pm 25% smoothed or 19 VAC \pm 15% full-wave rectified (18 VDC)
Power consumption ¹⁾	typ. 250 mA at 24 V 330 mA max. peak consumption with PCD7.F1xxx module or external I/O module support PCD3.C110 and GSM/GPRS communication (bad reception)
Capacity of internal 5 V bus ²⁾	600 mA
Capacity of internal +V bus (16...24 V) ²⁾	The capacity of the +V bus depends on the capacity of the 5V bus, as follows (the more precisely the 24 V are maintained, the higher the possible capacity): $24 \text{ V } \begin{matrix} -25\% \\ +30\% \end{matrix} : 100 \text{ [mA]}$ $24 \text{ V } \begin{matrix} -20\% \\ +25\% \end{matrix} : 150 - \frac{I_{5V \text{ Bus}}}{15} \text{ [mA]}$ $24 \text{ V } \begin{matrix} -10\% \\ +10\% \end{matrix} : 260 - \frac{I_{5V \text{ Bus}}}{4.8} \text{ [mA]}$
<p>1) The loads handled by the outputs and other consumers are generally more important for sizing the supply than the internal power leakage of the control</p> <p>2) When planning PCD3 systems, it is essential to check that the two internal supplies are not overloaded. This check is especially important when using analogue, counter and positioning modules, as these may have a very large power consumption. It is advisable to use the calculation table at www.sbc-support.com.</p>	
Atmospheric conditions	
Ambient temperature	When mounted on vertical surface with vertically aligned terminals: 0...+55 °C In all other mounting positions, a reduced temperature range of 0..+40 °C applies
Storage temperature	-20...+85 °C
Relative humidity	10...95% without condensation
Vibration resistance	
Vibration	according to EN/IEC61131-2: 5...13.2 Hz constant amplitude (1.42 mm) 13.2...150 Hz, constant acceleration (1 G)
Electrical safety	
Protection type	IP20 according to EN60529
Air/leakage paths	according to EN61131-2 and EN50178: between circuits and bodies and between electrically isolated circuits: surge category II, fouling level 2
Test voltage	350V / 50Hz AC for nominal unit voltage 24 VDC

Electromagnetic compatibility	
Electrostatic discharge	according to EN61000-4-2: 8 kV: contact discharge
Electromagnetic fields	according to EN61000-4-3: field intensity 10 V/m, 80...1000 MHz
Bursts	according to EN61000-4-4: 4 kV on DC supply lines, 4 kV on I/O signal lines, 1 kV on interface lines
Noise emission	according to EN61000-4-6: Class A (for industrial areas) Guidance on the correct use of these controls in residential areas can be found at www.sbc-support.com (additional measures).
Noise immunity	acc. to EN61000-6-4

Mechanism and mounting	
Housing material	Module holder: PC/ABS, light grey, RAL7035 I/O modules: PC, transparent blue Clips: PAM, orange, RAL2003 Fibre optics: PC, crystal-clear
Mounting rail	Top-hat rail according to EN 60715, TH35 (35 mm)

Connections						
Terminal blocks	Spring terminals 10-pole, 4-pole	Screw terminals 10-pole	Spring terminals 14-pole, 12-pole, 8-pole	Spring terminals 24-pole, 6-pole	Earth terminal	Terminal 2-pole supply
Section stranded single wire	0.5...2.5 mm ² 0.5...2.5 mm ²	0.5...2.5 mm ² 0.5...2.5 mm ²	0.5...1.5 mm ² 0.5...1.5 mm ²	0.5...1.0 mm ² 0.5...1.0 mm ²	0.08... 2.5 mm ²	0.5... 1.5 mm ²
The terminal blocks may only be plugged onto 20 times. They must then be replaced, to guarantee a reliable contact						
Length of insulation	7 mm	7 mm	7 mm	7 mm	5...6 mm	7 mm

2 PCD3.M2x30 Compact CPUs

2.1 Introduction

Two different types of PCD3 compact controller are available.

PCD3.M2030V6	---
PCD3.M2130V6	with Ethernet

The PCD3.M2x30V6 is the compact control device in the PCD3 family. It offers a set of digital and analogue I/O's already included in the base unit. The I/O extension connector gives the possibility to use **one** PCD3.C200 or PCD3.C110 extension with two or up to four modular I/O modules.

2.2 General Overview

The CPU functionality is similar to PCD3.M3230/ M3330. This manual specifies only the differences. Please refer to the PCD3 Hardware manual (P+P26/789) for the whole feature set.

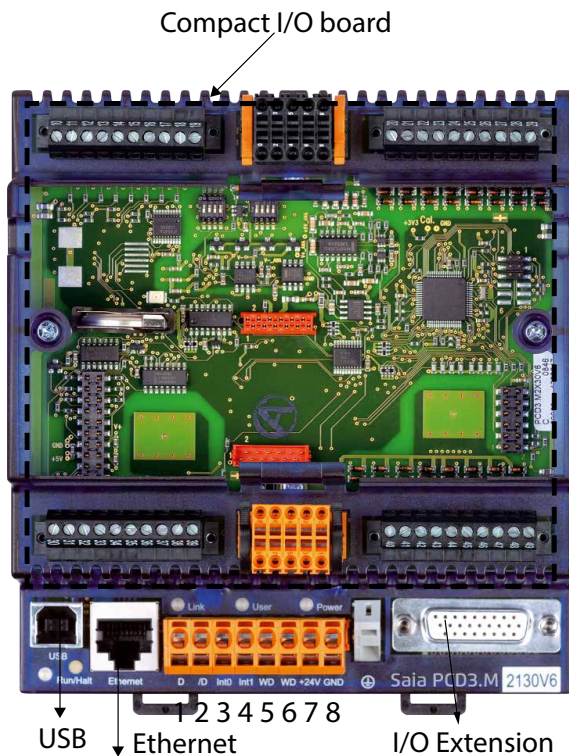

2.2.1 Characteristics

- Compact size: 130×140×75 mm (W × H × D)
- User program memory: 512 KByte RAM
- Flash onboard for user program backup: 512 KByte
- Flash onboard for file system: 1024 KByte
- USB, RS485, 2 interrupts onboard and integrated Web Server
- Ethernet TCP/IP (with PCD3.M2130V6 only)
- Data protection with removable lithium battery: 1-3 years
- 38 Data points with compact I/O Board V6:
 - 20 Digital Inputs (DI): 15...30 VDC, 0.3 ms „ON“-Delay. The first 6 of them are configurable either as
 - 6 standard inputs or
 - 2 counters with enable input and 2 standard inputs or
 - 2 encoders A, B and index signal or
 - 4 interrupts and 2 standard inputs
 - 12 Digital Outputs (DO): 24 VDC, 0.5A, transistors
 - 4 Analogue Inputs (AI): 13 Bit +/- 10 V; 12 Bit 0...10 V, 0...20 mA, 0...2500Ohm, Pt/Ni1000
 - 2 Analogue Outputs (AO): 12 Bit 0...10 V
- 1 port (socket A) for PCD7.F1xx
- Adequate pluggable screw terminal blocks included
- Options:
 - Pluggable “Push-in” terminal block with LEDs (10 poles - 1x plus, 1x ground, 8x I/O signals)
 - Pluggable “Push-in” terminal block with LEDs (3 x 10 poles, 3 wire connection)

2.3 Connections of the CPU

For all types				Profibus signal	Profibus wiring		
Terminal block for supply, watchdog, interrupt inputs and Port 2							
	Pin	Signal	Explanation				
	1	D	Port#2; RS485 up to 115.2 kbit/s usable as free user interface or Profi-S-Bus up to 187.5 kbits/s	RxD/TxD-N	A green		
	2	/D		RxD/TxD-P	B red		
	3	Int0	2 interrupt inputs 24 VDC or 1 fast counter 24 VDC				
	4	Int1					
	5	WD	Watchdog				
	6	WD					
	7	+24V	Power supply				
	8	GND					
RS485 terminator switch							
Switch position	Designation	Explanation					
left	O	without termination resistors					
right	C	with termination resistors					

2



The connections are the same like on all other PCD3 CPUs.

2.4 Description of the LEDs

The CPU can assume the following operating states:

Run, Run conditional, Run with error, Run cond. with error, Stop, Stop with error, Halt and System Diagnostics .

The display uses the LEDs shown below:

LED	Run/Halt	Link	User	Power
Colour	bi-colour	Yellow	Yellow	Yellow
Run	●	○	○	●
Run cond.	●/○	○	○	●
Run with error	●	○	●	●
Run cond. with error	●/○	○	●	●
Stop	○	○	○	●
Stop with error	○	○	●	●
Halt	●	○	○	●
System diagnostics	●/○	●/○	●/○	
Batt./Super Cap voltage absent	○	○	○	○
Communication		●		

○ LED off ● LED on ●/○ LED flashing

Start	Self-diagnosis for approx. 1 sec. after switching on or after a Restart
Run	Normal processing of the user program after Start. Where a programming unit is connected via a PCD8.K11x in PGU mode (e.g. PG5 in PGU mode), the CPU automatically goes into the Stop state and not the Run state; this is for safety reasons
Run conditional	Conditional Run state. A condition has been set in the debugger (Run until...), which has not yet been met
Run with error	Same as Run, but with an error message
Run cond. with error	Same as conditional Run, but with an error message
Stop	The Stop state occurs in the following cases: <ul style="list-style-type: none"> • Programming unit in PGU mode connected when the CPU was switched on • PGU stopped by programming unit • Condition for a COND.RUN has been met
Stop with error	Same as Stop, but with an error message
Halt	The Halt state occurs in the following cases: <ul style="list-style-type: none"> • Halt instruction processed • Serious error in user program • Hardware fault • No program loaded • no communication module on an S-Bus PGU or Gateway Master port
System diagnostics	
Reset	The RESET state has the following causes: <ul style="list-style-type: none"> • Supply voltage too low • Firmware not starting up

2.5 Dimensions

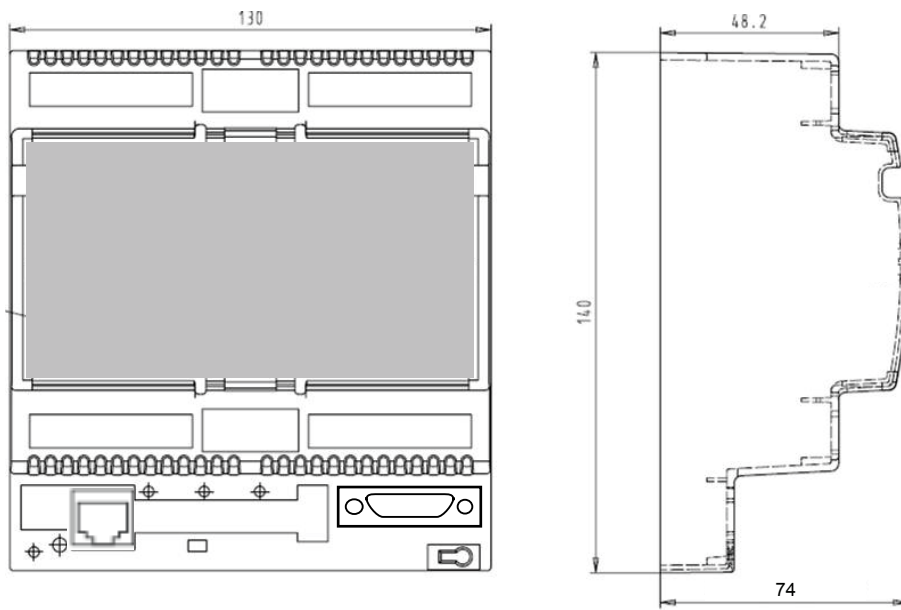

2

2.6 I/O Connections

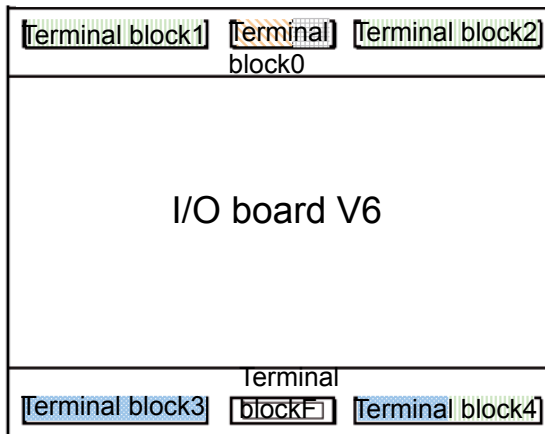

20 digitals inputs, 15...30 VDC
 Typical delay 3.5 µs/0.3 ms
12 digitals outputs, 24 VDC 0,5 A
 Transistors
4 analogue inputs, Range selection by switches,
 12 Bit, 0...20 mA, 0...10 VDC,
 Pt/Ni1000, Ni1000 L&S,
 Resistance 0...2500 Ω
 13 Bit, ±20 mA, ±10 VDC,
2 analogue outputs, 12 Bit, 0...10 V

2

Pluggable Terminal block 0			Pluggable Terminal block 1					
			Stand. Inputs		Counter	Encoder	Interrupt	
0	AI0	Analogue input 0	10	24V	Supply voltage 24V			
1	AI1	Analogue input 1	11	DI0	Digital input 0	Counter 0	A Encoder 0	Interrupt A
2	AI2	Analogue input 2	12	DI1	Digital input 1	Counter 0 En.	B Encoder 0	Interrupt B
3	AI3	Analogue input 3	13	DI2	Digital input 2	Digital input 2	Index Enc.0	Dig. input 2
4	AGND	Analogue GND	14	DI3	Digital input 3	Counter 1	A Encoder 1	Interrupt C
5	AGND	Analogue GND	15	DI4	Digital input 4	Counter 1 En.	B Encoder 1	Interrupt D
6	AO0	Analogue output 0	16	DI5	Digital input 5	Digital input 5	Index Enc.1	Dig. input 5
7	AO1	Analogue output 1	17	DI6	Digital input 6	Digital input 6	Dig. input 6	Dig. input 6
8	AGND	Analogue GND	18	DI7	Digital input 7	Digital input 7	Dig. input 7	Dig. input 7
9	AGND	Analogue GND	19	GND	Supply GND			

Pluggable Terminal block 2			Pluggable Terminal block 3			Pluggable Terminal block 4		
20	24V	Supply voltage 24V	30	GND	Supply GND	40	GND	Supply GND
21	DI8	Digital input 8	31	DO0	Digital output 0	41	DO8	Digital output 8
22	DI9	Digital input 9	32	DO1	Digital output 1	42	DO9	Digital output 9
23	DI10	Digital input 10	33	DO2	Digital output 2	43	DO10	Digital output 10
24	DI11	Digital input 11	34	DO3	Digital output 3	44	DO11	Digital output 11
25	DI12	Digital input 12	35	DO4	Digital output 4	45	DI19	Digital input 19
26	DI13	Digital input 13	36	DO5	Digital output 5	46	DI18	Digital input 18
27	DI14	Digital input 14	37	DO6	Digital output 6	47	DI17	Digital input 17
28	DI15	Digital input 15	38	DO7	Digital output 7	48	DI16	Digital input 16
29	GND	Supply GND	39	24V	Supply voltage 24V	49	24V	Supply voltage 24V

Pluggable Terminal block F	PCD7.F121	PCD7.F110		PCD7.F180	PCD7.F150
	RS232	RS485	RS422	Belimo	RS485 isolated
0	PGND	PGND	PGND	PGND	PGND
1	TxD	Rx-Tx	Tx	ACom	Rx-Tx
2	RxD	/Rx-/Tx	/Tx	,MFT'	/Rx-/Tx
3	RTS		Rx	,IN'	
4	CTS		/Rx		
5	PGND	PGND	PGND	PGND	PGND
6	DTR		RTS		
7	DSR		/RTS		
8	COM		CTS		SGD
9	DCD		/CTS		

2.6.1 Analogue Inputs (Part of Terminal block X0)

Number of inputs:	4
Galvanic separation:	no
Signal ranges:	-10...+10 V -20...+20 mA RTD
Resolution (digital representation):	12 bits + sign
Connection technique for sensors	2-wires (passive input)
Measuring principle:	Single ended
Input resistance:	±10 V range: 140 kΩ ±20 mA range: 125 Ω
Input filter:	typ. 5 ms
Input ranges for temperature sensors	PT1000: -50...+400 °C NI1000: -50...+210 °C NI1000 L&S: -30...+140 °C Resistance 0...2.5 kΩ
Accuracy at 25°C:	± 0.5%
Temperature error (0...+55°C):	± 0.25%
Overrange protection:	±10 V range: ± 35 V (39V TVS Diode) ±20 mA range: ±40 mA
LEDs	no
Terminals	pluggable “push in” terminal block 10-pole, 3.5 mm for wiring up to 1 mm ²

Configuration of the analogue input channels:

		U	C	T
CH0	SW1	1 OFF 2 OFF	1 ON 2 OFF	1 OFF 2 ON
CH1	SW1	3 OFF 4 OFF	3 ON 4 OFF	3 OFF 4 ON
CH2	SW2	1 OFF 2 OFF	1 ON 2 OFF	1 OFF 2 ON
CH3	SW2	3 OFF 4 OFF	3 ON 4 OFF	3 OFF 4 ON

As shown in the picture above, analogue input range selection is done by configuration switches. Following ranges are supported:

- Voltage ±10 V Both switches off (see channel 0 configuration above)
- Current ±20 mA Switch 'C' on, Switch 'T' off (See channel 1 configuration above)
- Temperature/Resistance Switch 'T' on, Switch 'C' off (See channel 2 & 3 configuration above)

Connection concept

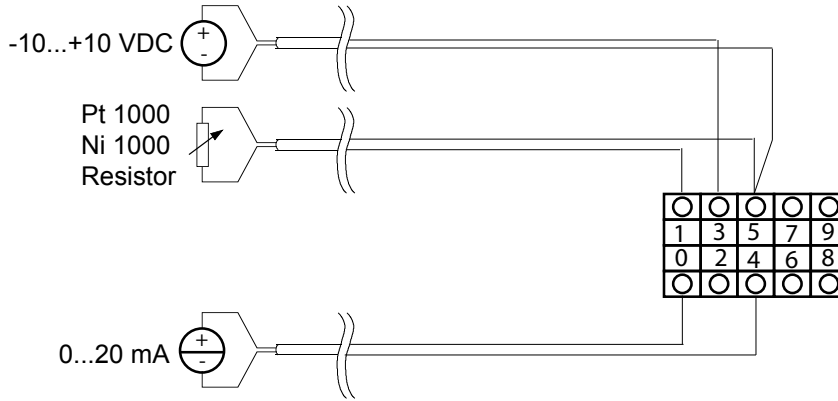

Connection concept for two-wire transducers

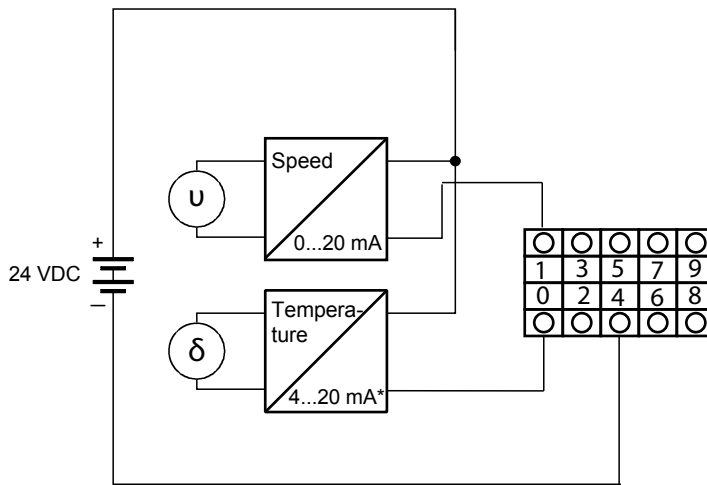

*4...20 mA via userprogram

2.6.2 Analogue Outputs (Part of Terminal block X0)

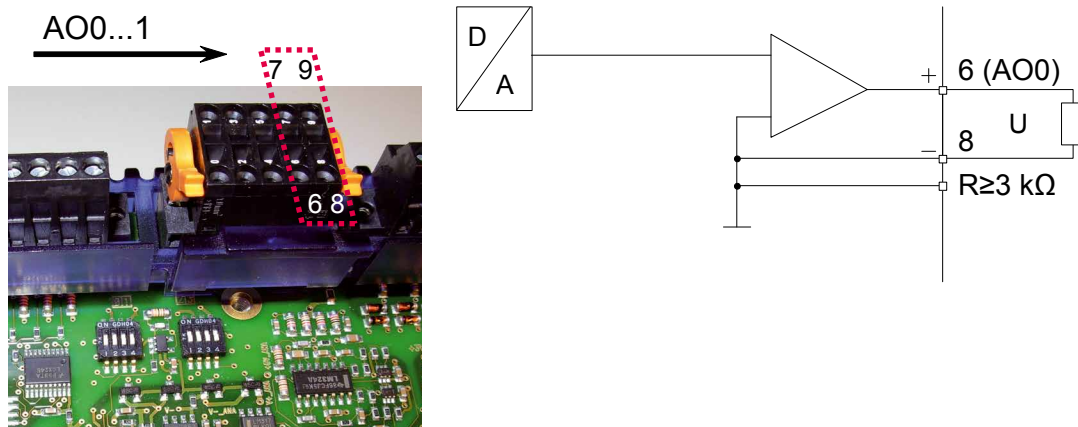

Number of outputs (channels)	2
Signal range	0...10 V
Galvanic separation	nein
Resolution	12 bits
Accuracy at 25°C	± 0.5%
Temperature error	± 0.3% (Temperature range 0...50 °C)

2.6.3 Digital Inputs (Terminal block 1,2 and part of 4)

Number of inputs:	20, electrically connected, source operation
Input voltage:	24 VDC (15...30 VDC)
Input current:	typ. 4 mA at 24 VDC
Input delay:	typ. 3.5 µs for input 0...5, max. counting frequency 30 kHz; typ. 0.3 ms for input 6...19
Overvoltage protection:	no
LEDs	no (Option: connector with LEDs)
Terminals	plug-in screw terminal block

2

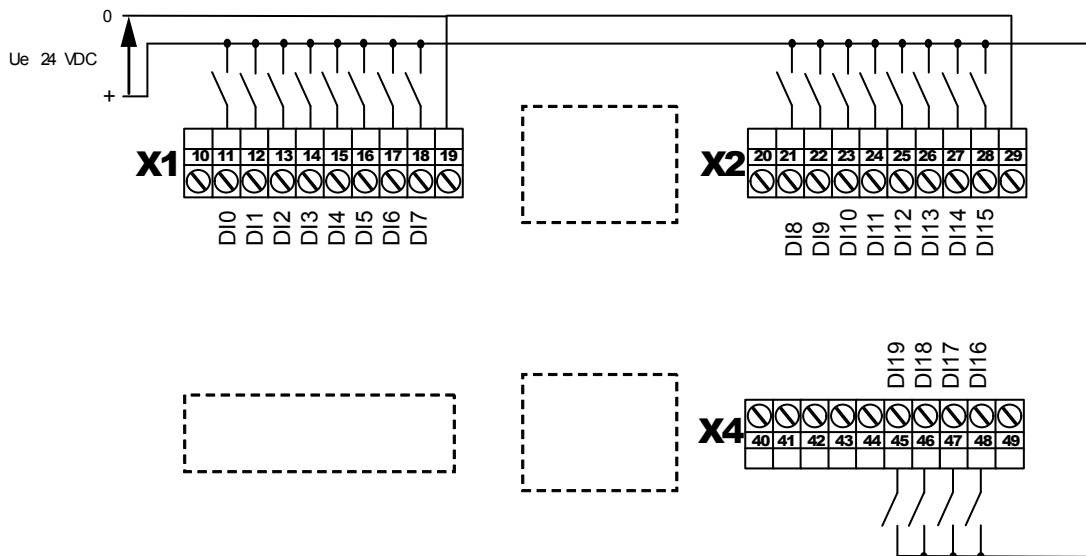

2.6.4 Digital Outputs (Terminal block 3 and part of 4)

Number of outputs:	12
Voltage range:	24 VDC (12...32 VDC) smoothed
Output current:	max. 0.5 A
Output delay:	typ. 50 µs, max. 100 µs with ohmic load
Contact protection	transistors
LEDs	no (Option: connector with LEDs)
Terminals	plug-in screw terminal block

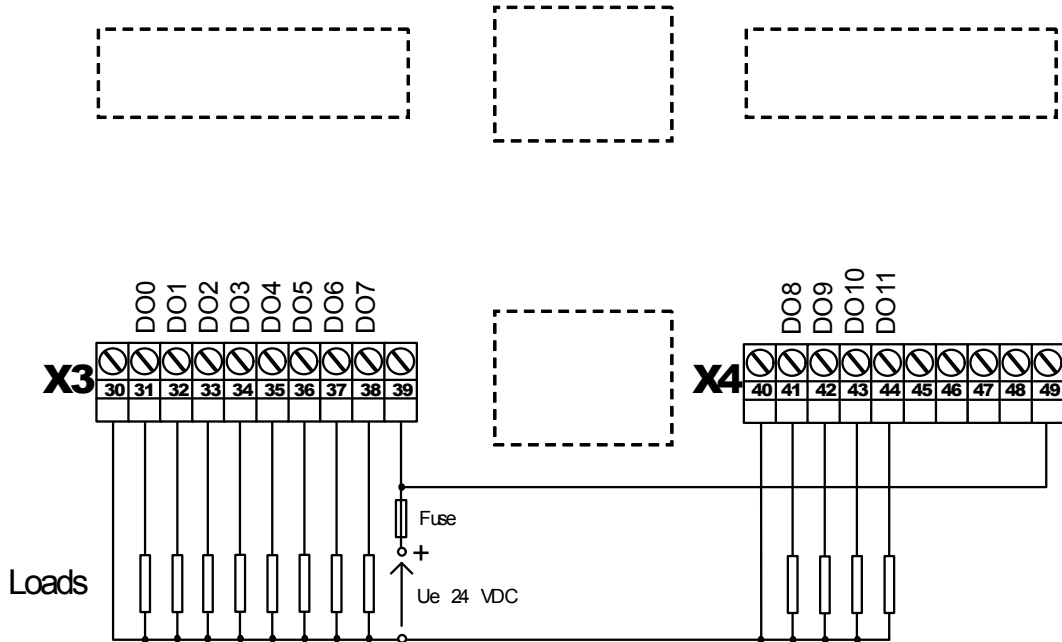

2.6.5 Terminal block with “Push In” system and LEDs (optional)



4 405 5066 0

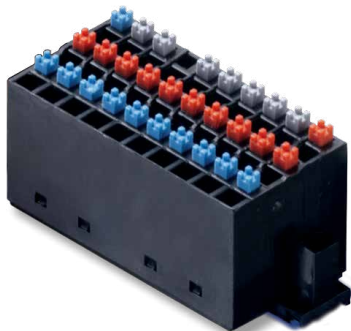

4 405 5079 0

- Push In
 - for solid wires
 - for flexible wires
 - with or without ferrules
 - 1.5mm² wire size with or without ferrules
- Easy handling
 - Simply insert the wire to connect it
 - Push the button to remove the wire
- LEDs
 - Clear and save monitoring of the signals

There are 2 versions available:

4 405 5066 0 Pluggable “Push-in” terminal block with LEDs, 10-pole, as connector for X1, X2, X3 & X4

or

4 405 5079 0 Pluggable “Push-in” terminal block with LEDs, 3x10 pole (3-wire connection) as connector for X1, X2, X3 & X4

3 Communication interfaces

3.1 Ethernet

Please refer to the PCD3 Hardware manual for more information.

3.2 USB

Please refer to the PCD3 Hardware manual for more information.

3.3 Onboard Serial ports

Like on the other PCD3 CPUs



. 1 2 3 4 5 6 7 8

Please refer to the PCD3 Hardware manual for more information.

3.4 Communication ports with socket A

Socket A on the CPU

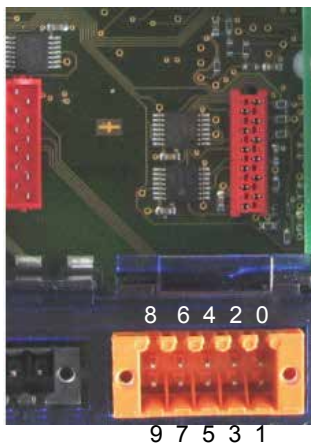

Possible F-Modules Serie PCD7.F1xx

PCD7.F110 serial Interface module RS-422 / RS-485

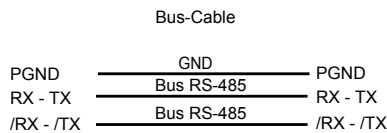
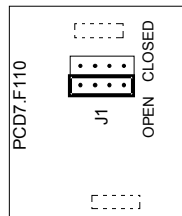
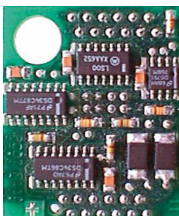

RS-422				RS-485			
0	PGND	Tx	1	0	PGND	Rx-Tx	1
2	/Tx	Rx	3	2	/Rx-/Tx		3
4	/Rx	PGND	5	4		PGND	5
6	RTS	/RTS	7	6			7
8	CTS	/CTS	9	8	(SGD)		9

PCD7.F121 Serial interface module RS-232 suitable for modem connection
(PCD7.F120 will not be supported)

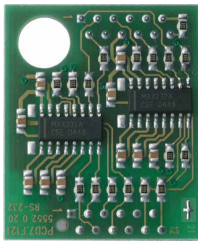

RS-232

0	PGND	TxD	1
2	RxD	RTS	3
4	CTS	PGND	5
6	DTR	DSR	7
8	COM	DCD	9

3

PCD7.F150 Connection for RS-485 with electrical isolation

The electrical isolation is achieved with 3 optocouplers and a DC/DC transducer. The data signals are protected against surges by a suppressor diode (10 V). The line termination resistors can be connected/disconnected with a jumper.

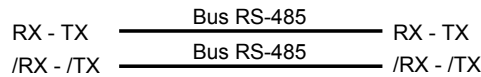

-485

0	PGND	Rx-Tx	1
2	/Rx-/Tx		3
4		PGND	5
6			7
8	(SGD)		9



Use of this module will reduce the allowed ambient temperature of the operating system about 5 °C.

PCD7.F180 serial interface module for Belimo MP-Bus max. 8 actuators and sensors connectable



MP MP-Bus signal line (18 V in/out)
,MFT' MFT-parametrising (MP-Bus intern)
,IN' MFT-parametrising detection (Input 10 kOhm, Z5V1)
GND Ground connection MFT-Parametrising unit

Belimo MP-Bus

0	GND	MP	1
2	,MFT'	,IN'	3
4		GND	5
6			7
8			9

4 Input/output (I/O) modules

If there is the need to extend the basic unit you will have the possibility to add one further extension module out of the PCD3 range (PCD3.C200Z09 or PCD3.C110Z09) and to equip them with PCD3 I/O modules. Well over 45 different types of I/O modules (digital, analogue, counters) are available.

For further details about the PCD3 I/O modules see chapter 6 of the PCD3 manual, 26-789.

5 Configuration

5.1 General

The following description assumes that the user is familiar with the Saia PG5® software.

If not, you are advised to read manual 26/733 “Saia PG5®”.

Software requirements: Saia PG5® V 2.0 or Saia PG5® 1.4.300 with patch 7 or a higher version.

This chapter shows how to use the onboard IOs of the PCD3 Compact with new Device Configurator. The Device Configurator defines:

- A cyclically media mapping to enable a link between peripheral I/O modules values and the device resources (Saia PCD® Media).
- Direct access programming instructions to read value from the peripheral input module and write value to the peripheral output module.

5

IO handling is always enabled for the PCD3.M2x30V6.

Via direct access there is no bit access command. The minimal access range is “byte”, therefore we recommend to use the media mapping to read/write all I/O channels.

For more details refer to the help texts of the Device Configurator.

5.2 Hardware configuration-Device Configurator

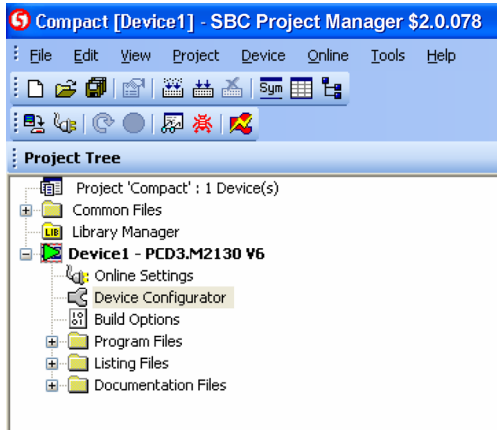

For the hardware configuration use the Device Configurator in Saia PG5® 2.0.

5

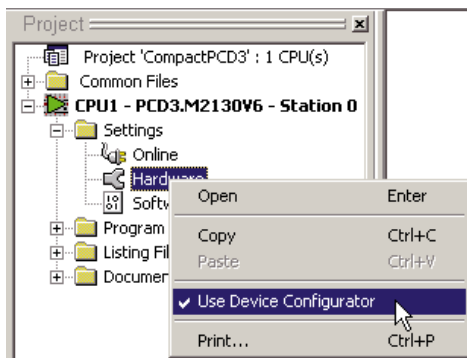

For the configuration in Saia PG5® 1.4.300 use the device configurator instead of the normal Hardware Settings window.

Click right mouse button on “Hardware” and select “Use Device Configurator”.

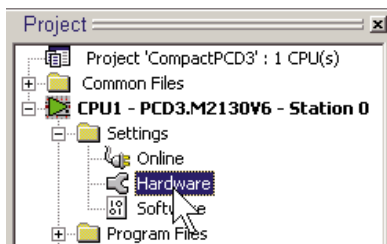

- Starting the Device Configurator.

Double click on “Hardware”.

The Device Configurator takes longer to be open/start at the first time (.Net loading)

Device Configurator overview

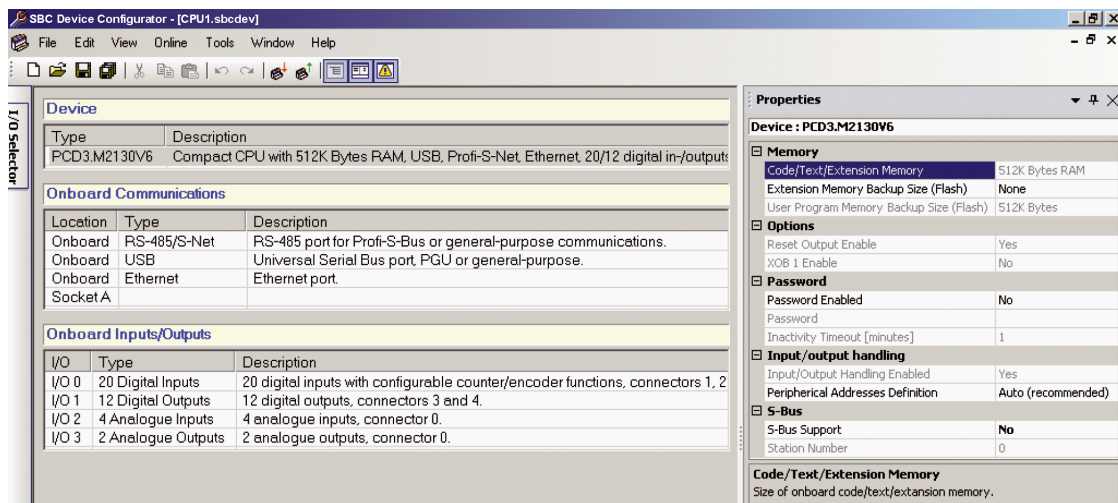

5.3 Digital inputs properties

5.3.1 General

All first 6 inputs (0 to 5) can be used either as:

- standard inputs with input filter 3.5 us (chap. 5.3.2)
- up to 2 counters, up to 30 kHz,
with enable input and 2 standard inputs (chap. 5.3.3)
- up to 2 encoders A, B, and index signal, up to 30 kHz (chap. 5.3.4)
- up to 4 interrupts and 2 standard inputs. (chap. 5.3.5)

Those multiple modes must be selected under “Input Mode” property.

All digital inputs of the PCD3 Compact PC module can be mapped in flags or registers.

Select under “Onboard Inputs/Outputs” the line I/O 0, all corresponding properties appear on the right side.

a) Accessing over flags mapping

- 1) Enabled “Media mapping”
- 2) Select “Media” Type as “Flag”
- 3) Give first “Media Address” x

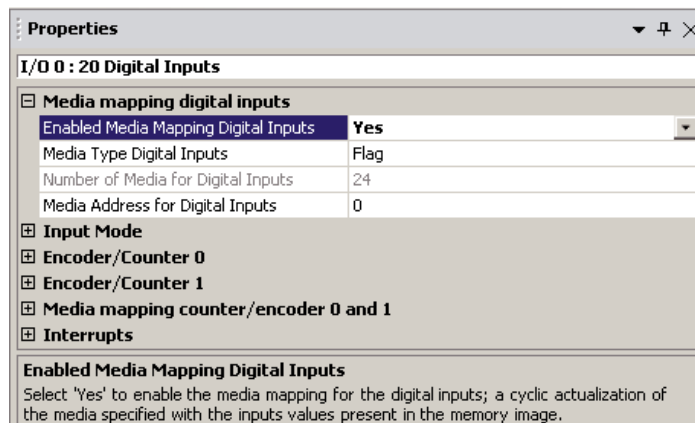

The “inputs” flags are updated before COB 0 starts with the current inputs state:

Example: x=0

- F0 = DI0
- F1 = DI1
- ...
- F19 = DI19



F20 to F23 will be put to ‘0’ value.

b) Accessing over registers mapping

- 1) Enabled
"Media mapping"
- 2) Select
"Media Type" as "Register"
- 3) Give first
"Media Address" x

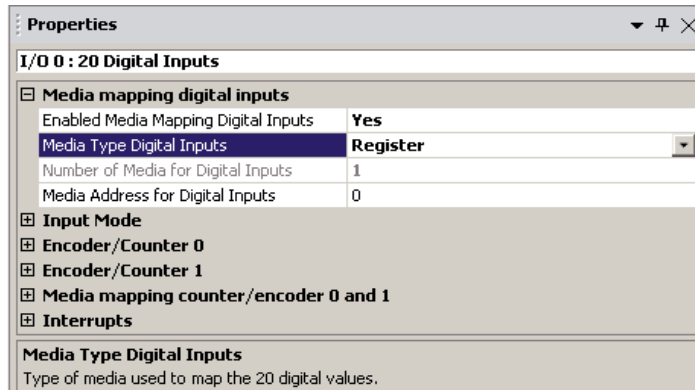

5

The "input" registers are updated before the first COB starts with the current inputs state:

- Bit0 of R0 = DI0
- Bit1 of R0 = DI1
- ...
- Bit19 of R0 = DI19



Bit20 to Bit31 of R0 will be put to '0' value

5.3.2 Standard inputs

a) Input Mode

Select "Mode for Inputs 0 to 2" and "Mode for Inputs 3 to 5" as "Standard Inputs" (defined as default Input mode).

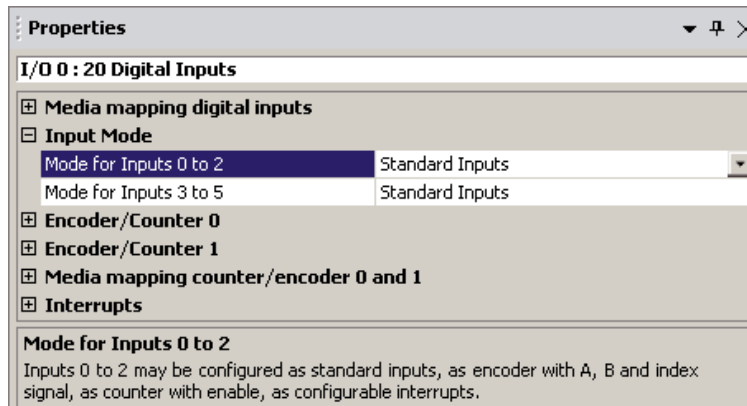

5.3.3 Counters with enable input

a) Input Mode

Select “Mode for Inputs 0 to 2” as
 “Counter 0 (0,1)...” and/or
 “Mode for Inputs 3 to 5” as
 “Counter 1 (3,4) ...”

Input 1 and input 4 are used to enable counters 0 and 1 to count up.

b) Accessing over register mapping

- 1) Enabled Media mapping
- 2) Give first “Media Address” y

The “counter” registers are updated before the COB 0 starts with counter’s value:

- Ry = Counter 0
- Ry+1 = Counter 1

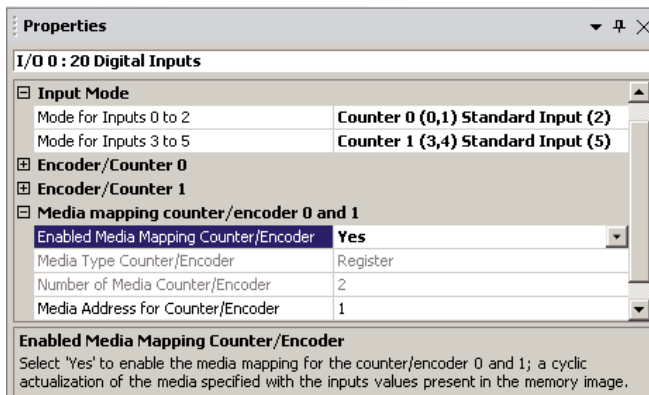

If digital inputs are mapped to flags (see (a) of chap.5.3.2) then example F0, F1 & F3, F4 will show the state of the counter as standard inputs.

Or if digital inputs are mapped to register (see (b) of chap. 5.3.2) then Bit0, 1 & Bit3, 4 of Rx will show the state of the counter as standard inputs.

c) Counter's properties (for Counter 0, same for Counter 1)

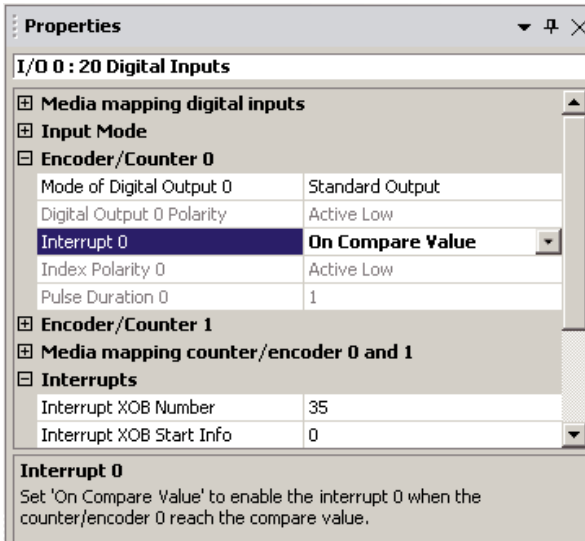

5

With the option “On Compare Value” the XOB 35 is activated when the counting value is equal to the compare value. (Default “No”)

<p>Digital output 0 can be used as “CCO” when the compare value of the counter 0 is reached. (Default “Standard output”)</p>	<p>Select the Digital output 0 polarity “Active Low” or “Active high”. In “Active Low” as such that compare value in not reached output is high then goes to low when value is reached. (Default “Active Low”)</p>	<p>CCO will stay active during x counting steps before changing state. (Default “1”)</p>

d) Counting block diagram

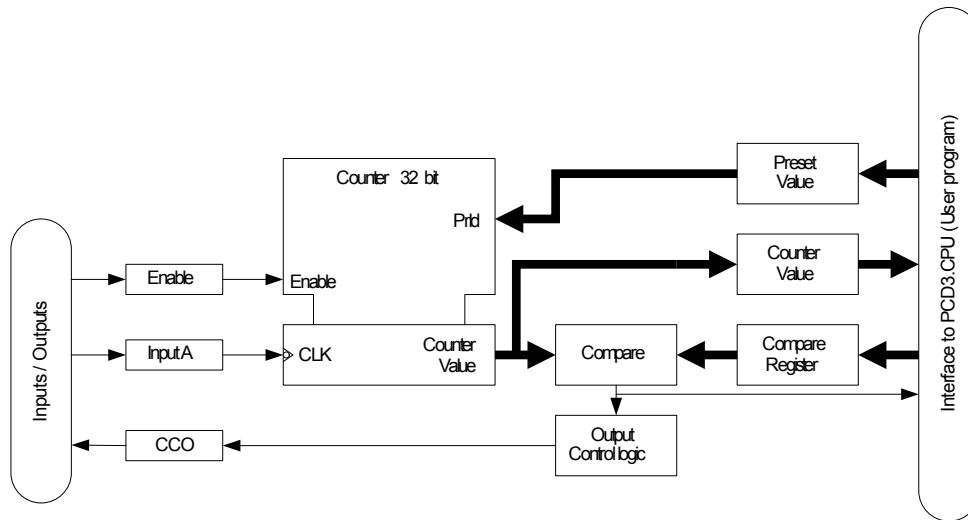

e) Counting description:

The counter offers the following inputs, outputs and configuration possibilities:

- Counting input (input A): **Falling edge** causes a counting pulse.
- Enable input: The Enable input must be statically high so that the counter counts pulses.
(And - connected with software Enable of the SaiaPCD®)
- CCO (output): Counter Controlled output, configurable as comparison value indicator (dynamic).
The CCO remains active during a configurable number of counting steps.
- Preset Value: The writing of the Preset-Value overwrites the current counter value.
- Counter Value: (Returns the) current counter value.
- Compare register: The counter value is compared with the Compare Value. As soon as the counter value has reached the comparison value, the CCO is switched to active or/and a XOB is executed on the SaiaPCD®.
The logic comparison is always sharp-switched for one line with the writing of a Compare Value for comparison. In order to cause a further comparison, the Compare register must be rewritten again. With the writing of the Compare Value, the CCO returns to the initial place; if it is still active.

f) Counting functions

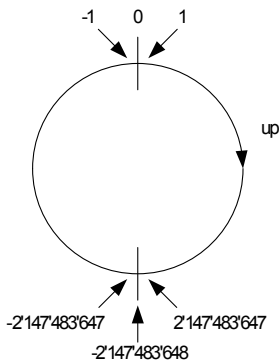

The counter works as a **32 bit counter**. If the counting value is considered, as a signed value, the counter works as shown in the picture on the left.

Counting range: -2'147'483'648 ...0...+2'147'483'647

In case of counting further upwards after the max. counting value is reached, the counter jumps to the lowest neg. value and continues counting upwards.

There is no Overflow-Indication.

When switching on, the counter is initialized to zero (0).

g) Compare – function and CCO (Counter Controlled Output)

The Compare - function compares the counters value with the Compare-register. As soon as the counter value is equal to the compared value, CCO is activated or a XOB is executed, depending on configuration.

With the writing of a new Compare Value, the CCO is always set to inactive state.

Possibilities in the SaiaPCD® user program:

The event ,reading = Compare Value , can be configured to trigger a XOB.

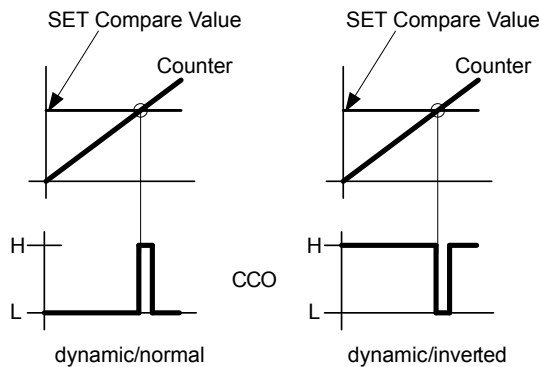

h) Program instructions

System symbol names:

Counter x (x= 0 or 1):

Preset value => S.IO.PRESET_VALUE_ENCODER_COUNTER_x

Compare value => S.IO.COMPARE_VALUE_ENCODER_COUNTER_x

Counter value => S.IO.COUNTER_ENCODER_x

Counter's initialization (for counter 0, the same for counter 1 using corresponding system symbol name):

1) Loading of the Preset value with following list instruction

```
WRP S.IO.PRESET_VALUE_ENCODER_COUNTER_0 ; ex. value from R100 is
                                           ; written
R 100                                     ; into system preset_val
                                           ; ue_counter
```

2) Loading of the Compare value with following list instruction

```
WRP S.IO.COMPARE_VALUE_ENCODER_COUNTER_0 ; ex. value from
                                           ; R101 is written
R 101                                     ; into system com-
                                           ; pare_value_
                                           ; counter
```

Counter value:

Reading of this last value through one destination register with following instruction

```
RDP S.IO.COUNTER_ENCODER_0
R 102
```

This value can also be cyclically mapped into one register (see (b)).

Interrupts Status:

“On compare value” must be configured for the Interrupt 0

```
RDP S.IO.INTERRUPT_STATUS ; Interrupts Status is copied
R 106                     ; from system Interrupt status into R 106
```

Interrupt Status Byte							
Int D		Int C/ Enc 1		Int B		Int A/Enc 0	
ILost	Int	ILost	Int	ILost	Int	ILost	Int
Int	,1'	Interrupt due edge at the input. In case of a configured interrupt with “Rising and falling edge”, it is possible, through the reading on the corresponding Input, to define the edge. Is the corresp. Input 0: → falling edge. Is the corresp. Input 1: → rising edge					
ILOST	,1'	Interrupt appears, before one already present interrupt was acknowledged.					

By reading the interrupt's status Byte, interrupt will be acknowledged!

5.3.4 Encoders with A, B and index signal

a) Input Mode

Select “Mode for Inputs 0 to 2” as “Encoder 0 (0,1,2)” and/or “Mode for Inputs 3 to 5” as “Encoder 1 (3,4,5)”.

b) Accessing over register mapping

- 1) Enabled Media mapping
- 2) Give first “Media Address” y

The “encoder” registers are updated before COB 0 starts with encoder’s value:

- Ry = Encoder 0
- Ry+1 = Encoder 1

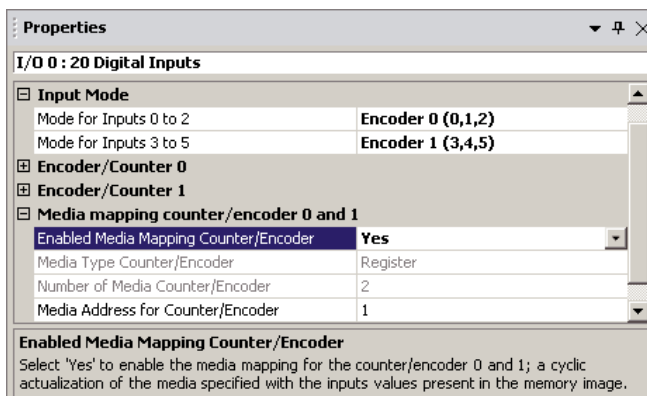

If digital inputs are mapped to flags (see (a) of chap. 5.3.2) then F0 to F5 will show the state of the encoders as standard inputs.

Or if digital inputs are mapped to register (see (b) of chap. 5.3.2) then Bit0 to Bit5 of Rx will show the state of the encoders as standard inputs.

c) Encoder’s properties (for Encoder 0, same for Encoder 1)

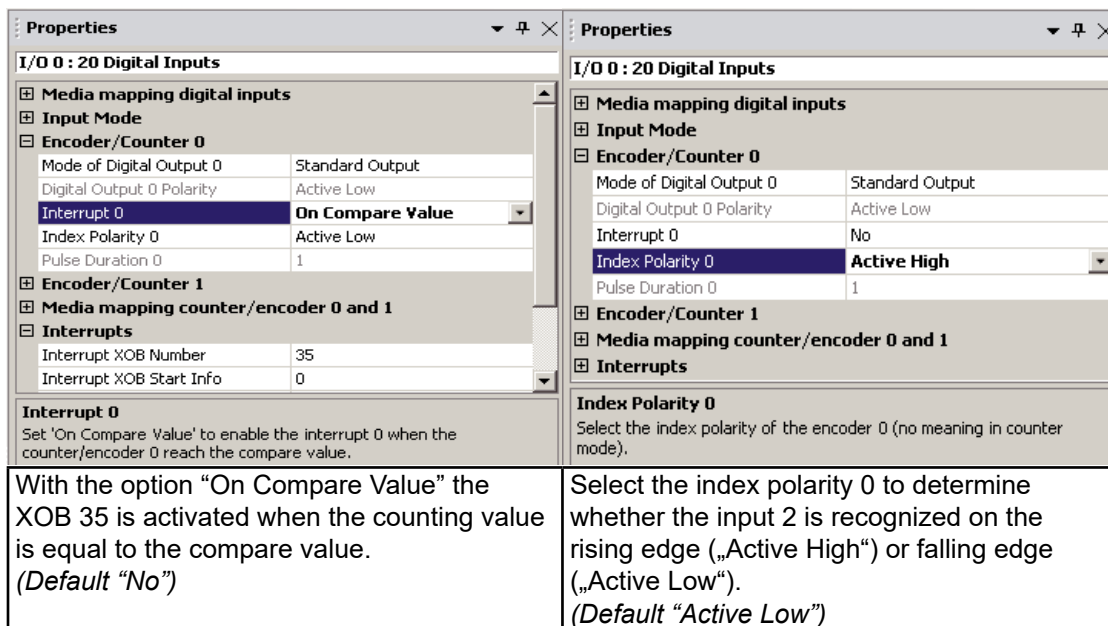

<p>Properties I/O 0 : 20 Digital Inputs</p> <p>Media mapping digital inputs</p> <p>Input Mode</p> <p>Encoder/Counter 0</p> <p>Mode of Digital Output 0 Counter Controlled Output (CCO)</p> <p>Digital Output 0 Polarity Active Low</p> <p>Interrupt 0 No</p> <p>Index Polarity 0 Active Low</p> <p>Pulse Duration 0 1</p> <p>Encoder/Counter 1</p> <p>Media mapping counter/encoder 0 and 1</p> <p>Interrupts</p> <p>Mode of Digital Output 0</p> <p>Set the digital output 0 as standard output or as counter controlled output (CCO) for counter/encoder 0.</p>	<p>Properties I/O 0 : 20 Digital Inputs</p> <p>Media mapping digital inputs</p> <p>Input Mode</p> <p>Encoder/Counter 0</p> <p>Mode of Digital Output 0 Counter Controlled Output (CCO)</p> <p>Digital Output 0 Polarity Active High</p> <p>Interrupt 0 No</p> <p>Index Polarity 0 Active Low</p> <p>Pulse Duration 0 1</p> <p>Encoder/Counter 1</p> <p>Media mapping counter/encoder 0 and 1</p> <p>Interrupts</p> <p>Digital Output 0 Polarity</p> <p>Polarity of the output 0 when used as indicator when counter/encoder 0 reaches the compare value.</p>	<p>Properties I/O 0 : 20 Digital Inputs</p> <p>Media mapping digital inputs</p> <p>Input Mode</p> <p>Encoder/Counter 0</p> <p>Mode of Digital Output 0 Counter Controlled Output (CCO)</p> <p>Digital Output 0 Polarity Active High</p> <p>Interrupt 0 No</p> <p>Index Polarity 0 Active Low</p> <p>Pulse Duration 0 10</p> <p>Encoder/Counter 1</p> <p>Media mapping counter/encoder 0 and 1</p> <p>Interrupts</p> <p>Pulse Duration 0</p> <p>Duration (number of steps) of the digital output activation after the counter/encoder 0 reaches the compare value.</p>
<p>Digital output 0 can be used as "CCO" when the compare value of the counter 0 is reached. <i>(Default "Standard output")</i></p>	<p>Select the Digital output 0 polarity "Active Low" or "Active high". In "Active Low" as such that compare value in not reached output is high then goes to low when value is reached. <i>(Default "Active Low")</i></p>	<p>CCO will stay active during x counting steps before changing state. <i>(Default "1")</i></p>

d) Encoding block diagram

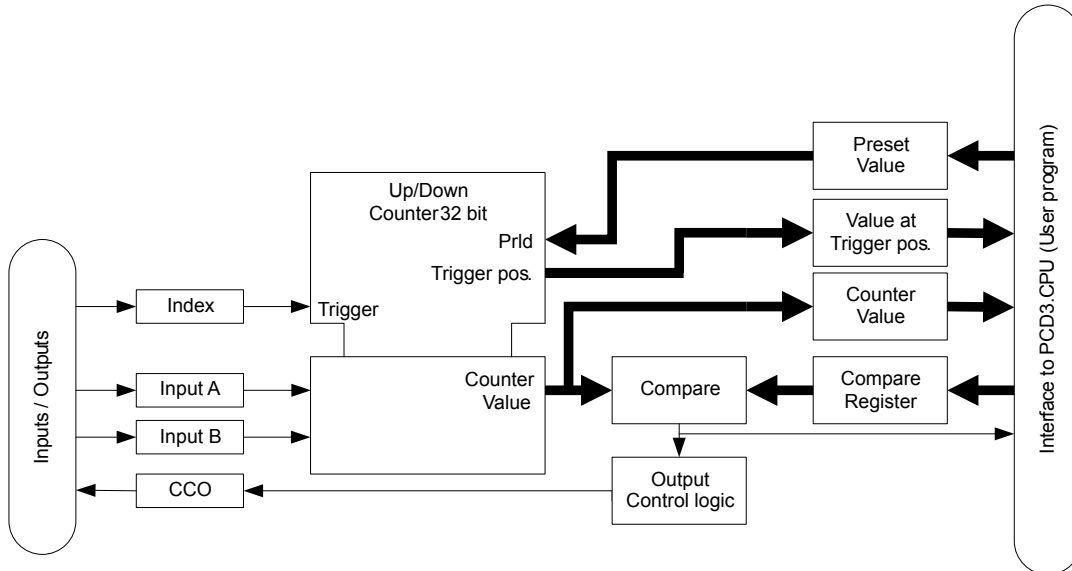

e) Encoding description

The encoder offers the following inputs, outputs and configuration possibilities:

- Counting inputs: Counting inputs A and B are designed for the connection
(Input A and B) of encoders signals. The counting act for rising and falling edge
of both signals, the counting direction results out of the phase
position of both Signal A and B.
- Trigger (index): With the Trigger – Input (Index) the counter is reset to 0 by an
external event. The 'old' counting value is memorised and can
be read back afterwards.
The Trigger is enabled by the user program and it is active until
the event occurs. Afterwards the counter continues running in
normal operating mode.
- CCO (output): Counter Controlled output, configurable as comparison value
indicator (dynamic).
The CCO remains active during a configurable number of count-
ing steps.
- Preset Value: The writing of the Preset-Value overwrites the current counter
value.
- Counter Value: (Returns the) current counter value.
- Compare register: The counter value is compared with the Compare Value. As
soon as the counter value has reached the comparison value,
the CCO is switched to active or/and a XOB is executed on the
Saia PCD®.
The logic comparison is always sharp-switched for one time with
the writing of a Compare Value for comparison. In order to cause
a further comparison, the Compare register must be rewritten
again. With the writing of the Compare Value, the CCO returns
to the initial place; if it is still active.

f) Counting description

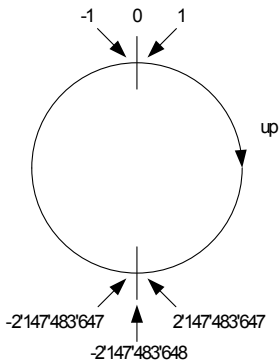

The counter works as a **32 bit counter**. If the counting value is considered, as a signed value, the counter works as shown in the picture on the left.

Counting range: -2'147'483'648 ...0...+2'147'483'647

In case of counting further upwards after the max. counting value is reached, the counter jumps to the lowest neg. value and continues counting upwards.

There is no Overflow-Indication.

When switching on, the counter is initialized to zero (0).

g) Compare – function and CCO (Counter Controlled Output)

The Compare - function compares the counters value with the Compare-register. As soon as the counter value is equal to the compared value, CCO is activated or a XOB is executed, depending on configuration.

With the writing of a new Compare Value, the CCO is always set to inactive state.

Possibilities in the Saia PCD® user program:

The event ,reading = Compare Value , can be configured to trigger a XOB.

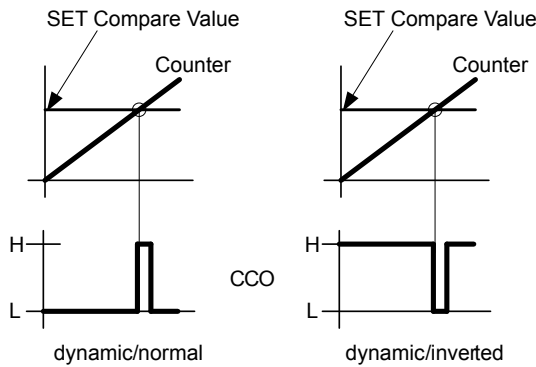

h) Program instructions

System symbol names:

Encoder x (x= 0 or 1):

- Preset value => S.IO.PRESET_VALUE_ENCODER_COUNTER_x
- Compare value => S.IO.COMPARE_VALUE_ENCODER_COUNTER_x
- Counter value => S.IO.COUNTER_ENCODER_x
- Set encoder RefMode=> S.IO.REF_MODE_ENCODER_0_AND_1
- RefMode Status => S.IO.ENCODER_x_STATUS_REF_MODE
- RefCounter Value => S.IO.ENCODER_x_REF_COUNTER

Encoder's initialization (for encoder 0, same for encoder 1 using corresponding system symbol name):

1) Loading of the Preset value with following list instruction

```
WRP S.IO.PRESET_VALUE_ENCODER_COUNTER_0 ; ex. value from R100 is
                                         ; written
                                         ; into system preset_val-
                                         ; ue counter
R 100
```

2) Loading of the Compare value with following list instruction

```
WRP S.IO.COMPARE_VALUE_ENCODER_COUNTER_0 ; ex. value from
                                         ; R101 is written
                                         ; into system com-
                                         ; pare_value_coun-
                                         ; ter
R 101
```

Encoder value:

Reading of the actual value through one destination register with following instruction

```
RDP S.IO.COUNTER_ENCODER_0 ; in DWord
R 102
```

This value can also be cyclically mapped into one register (see (b)).

Reference mode:

1) Start the reference mode of encoder with following instruction (valid for both encoders)

```
WRPB S.IO.REF_MODE_ENCODER_0_AND_1 ; in Byte
R 103
```

R value	0	No Influence for both encoder
	1	The encoder 0 will be switch in Reference mode & no influence on encoder 1
	16	The encoder 1 will be switch in Reference mode & no influence on encoder 0

2) Read the mode of the encoder with following instruction

```
RDPB S.IO.ENCODER_0_STATUS_REF_MODE ; in Byte
R 104
```

MODE	,0'	The encoder is not in the Reference mode
	,1'	The encoder is in Reference mode

3) Reading of counter value since the Set Reference mode to index signal through one destination register with following instruction

```
RDPW S.IO.ENCODER_0_REF_COUNTER ; in Word
      R 105
```

Interrupts Status:

“On compare value” must be configured for the Interrupt 0

```
RDP S.IO.INTERRUPT_STATUS ; Interrupts Status is copied
      R 106 ; from system Interrupt status into R 106
```

Interrupt Status Byte							
Int D		Int C/ Enc 1		Int B		Int A/Enc 0	
ILost	Int	ILost	Int	ILost	Int	ILost	Int
Int	,1'	Interrupt due edge at the input. In case of a configured interrupt with “Rising and falling edge”, it is possible, through the reading on the corresponding Input, to define the edge. Is the corresponding Input 0: → falling edge. Is the corresponding Input 1: → rising edge					
ILOST	,1'	Interrupt appears, before one already present interrupt was acknowledged.					

5

By reading the interrupt’s status Byte, interrupt will be acknowledged!

5.3.5 Interrupts

a) Input Mode

Select “Mode for Inputs 0 to 2” as
“Interrupts A and B (0,1)...”
and “Mode for Inputs 3 to 5” as
“Interrupts C and D (3,4)...”

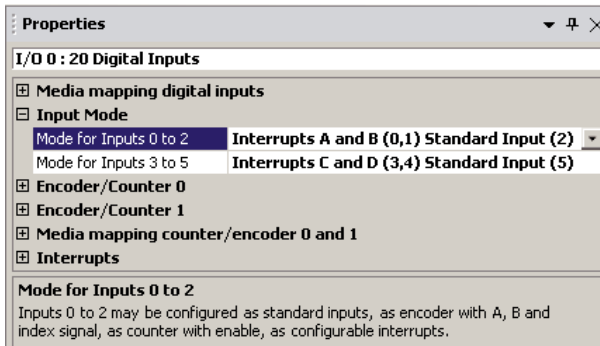

If digital inputs are mapped to flags (see (a) of chap. 5.3.2) then example F0 to F5 will show the state of the interrupts as standard inputs.
Or if digital inputs are mapped to register (see (b) of chap. 5.3.2) then Bit0 to Bit5 of Rx will show the state of the interrupts as standard inputs.

b) Interrupt's properties (for Interrupt A, the same for Interrupts B, C & D)

<p>Properties I/O 0 : 20 Digital Inputs</p> <p>Interrupts</p> <table border="1"> <tr><td>Interrupt XOB Number</td><td>35</td></tr> <tr><td>Interrupt XOB Start Info</td><td>0</td></tr> <tr><td>Interrupt A</td><td>Disabled</td></tr> <tr><td>Interrupt B</td><td>Disabled</td></tr> <tr><td>Interrupt C</td><td>Disabled</td></tr> <tr><td>Interrupt D</td><td>Disabled</td></tr> </table> <p>Interrupt A Select the type of the interrupt A. If the 'Mode for Inputs 0 to 2' is set to 'Interrupts A and B' and the 'Interrupt A' is set to 'Disabled', the interrupt can be activated by user program command.</p>	Interrupt XOB Number	35	Interrupt XOB Start Info	0	Interrupt A	Disabled	Interrupt B	Disabled	Interrupt C	Disabled	Interrupt D	Disabled	<p>Properties I/O 0 : 20 Digital Inputs</p> <p>Interrupts</p> <table border="1"> <tr><td>Interrupt XOB Number</td><td>35</td></tr> <tr><td>Interrupt XOB Start Info</td><td>0</td></tr> <tr><td>Interrupt A</td><td>On rising edge</td></tr> <tr><td>Interrupt B</td><td>Disabled</td></tr> <tr><td>Interrupt C</td><td>Disabled</td></tr> <tr><td>Interrupt D</td><td>Disabled</td></tr> </table> <p>Interrupt A Select the type of the interrupt A. If the 'Mode for Inputs 0 to 2' is set to 'Interrupts A and B' and the 'Interrupt A' is set to 'Disabled', the interrupt can be activated by user program command.</p>	Interrupt XOB Number	35	Interrupt XOB Start Info	0	Interrupt A	On rising edge	Interrupt B	Disabled	Interrupt C	Disabled	Interrupt D	Disabled
Interrupt XOB Number	35																								
Interrupt XOB Start Info	0																								
Interrupt A	Disabled																								
Interrupt B	Disabled																								
Interrupt C	Disabled																								
Interrupt D	Disabled																								
Interrupt XOB Number	35																								
Interrupt XOB Start Info	0																								
Interrupt A	On rising edge																								
Interrupt B	Disabled																								
Interrupt C	Disabled																								
Interrupt D	Disabled																								
<p>When the Interrupts are disabled, they can also be configured by the user program. . See next chapter -- (c) program instructions)</p>	<p>Interrupt A will activate XOB 35 if the input 0 goes from low to high ("On rising edge").</p>																								
<p>Properties I/O 0 : 20 Digital Inputs</p> <p>Interrupts</p> <table border="1"> <tr><td>Interrupt XOB Number</td><td>35</td></tr> <tr><td>Interrupt XOB Start Info</td><td>0</td></tr> <tr><td>Interrupt A</td><td>On falling edge</td></tr> <tr><td>Interrupt B</td><td>Disabled</td></tr> <tr><td>Interrupt C</td><td>Disabled</td></tr> <tr><td>Interrupt D</td><td>Disabled</td></tr> </table> <p>Interrupt A Select the type of the interrupt A. If the 'Mode for Inputs 0 to 2' is set to 'Interrupts A and B' and the 'Interrupt A' is set to 'Disabled', the interrupt can be activated by user program command.</p>	Interrupt XOB Number	35	Interrupt XOB Start Info	0	Interrupt A	On falling edge	Interrupt B	Disabled	Interrupt C	Disabled	Interrupt D	Disabled	<p>Properties I/O 0 : 20 Digital Inputs</p> <p>Interrupts</p> <table border="1"> <tr><td>Interrupt XOB Number</td><td>35</td></tr> <tr><td>Interrupt XOB Start Info</td><td>0</td></tr> <tr><td>Interrupt A</td><td>On rising and falling edge</td></tr> <tr><td>Interrupt B</td><td>Disabled</td></tr> <tr><td>Interrupt C</td><td>Disabled</td></tr> <tr><td>Interrupt D</td><td>Disabled</td></tr> </table> <p>Interrupt A Select the type of the interrupt A. If the 'Mode for Inputs 0 to 2' is set to 'Interrupts A and B' and the 'Interrupt A' is set to 'Disabled', the interrupt can be activated by user program command.</p>	Interrupt XOB Number	35	Interrupt XOB Start Info	0	Interrupt A	On rising and falling edge	Interrupt B	Disabled	Interrupt C	Disabled	Interrupt D	Disabled
Interrupt XOB Number	35																								
Interrupt XOB Start Info	0																								
Interrupt A	On falling edge																								
Interrupt B	Disabled																								
Interrupt C	Disabled																								
Interrupt D	Disabled																								
Interrupt XOB Number	35																								
Interrupt XOB Start Info	0																								
Interrupt A	On rising and falling edge																								
Interrupt B	Disabled																								
Interrupt C	Disabled																								
Interrupt D	Disabled																								
<p>Interrupt A will activate XOB 35 if the input 0 goes from high to low ("On falling edge").</p>	<p>Interrupt A will activate XOB 35 if the input 0 goes from low to high and also from high to low ("On rising and falling edge").</p>																								

All other interrupts have the same properties and are freely configurable. All interrupts are calling the same XOB. Read the status of all enabled Interrupts into this XOB to run the corresponding program part.

Interrupts Status:

"On compare value" must be configured for the Interrupt 0.

```
RDP S.IO.INTERRUPT_STATUS ; Interrupts Status is copied
R 106 ; from system Interrupt status into R 106
```

Interrupt Status Byte							
Int D		Int C/ Enc 1		Int B		Int A/Enc 0	
ILost	Int	ILost	Int	ILost	Int	ILost	Int
Int	,1'	Interrupt due edge at the input. In case of a configured interrupt with "Rising and falling edge", it is possible, trough the reading on the corresponding Input, to define the edge. Is the corresponding Input 0: → falling edge. Is the corresponding Input 1: → rising edge					
ILOST	,1'	Interrupt appears, before one already present interrupt was acknowledged.					

By reading the interrupt's status Byte, interrupt will be acknowledged!

5.4 Digital outputs properties

The digital outputs of the PCD3 Compact can be mapped in flags or registers. Select under “Onboard Inputs/Outputs” the line I/O 1, all corresponding properties appears on the right side.

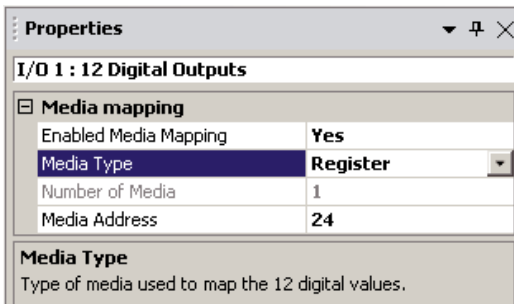
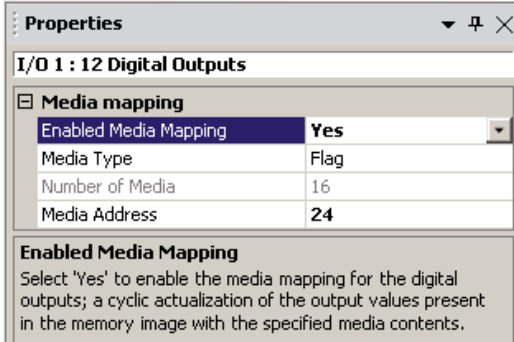

- a) Accessing over flags mapping
 - 1) Enabled Media mapping
 - 2) Select “Media Type” as “Flag”
 - 3) Give first “Media Address” y

The Flags states are transferred to outputs DO 0 until DO 11 at COBs end.

Example: y=24

- DO0 = F24
- DO1 = F25
- ...
- DO11 = F35

F 36 to F 39 have always '0' bit

- b) Accessing over registers mapping
 - 1) Enable Media mapping
 - 2) Select “Media Type” as “Register”
 - 3) Give first “Media Address” y

The register’s value (,Low’-Bits) is transferred to outputs DO 0 until DO 11 at COBs end:

- DO0 = Bit0 of R24
- DO1 = Bit1 of R24
- ...
- DO11 = Bit11 of R24

Bit12 to Bit31 of R24 have always '0' value.

5.5 Analogue inputs properties

The analogue inputs of the PCD3 Compact can be mapped in registers. Select under “Onboard Inputs/Outputs” the line I/O 2, all corresponding properties appears on the right side.

a) Accessing over registers mapping

- 1) Enable Media Mapping
- 2) Give first “Media Address”

The 4 “inputs” registers are updated when the COB 0 starts with the current values of analogue inputs:

Example: First media address = 0

- R0 = AI0
- R1 = AI1
- R2 = AI2
- R3 = AI3

b) Filter activation and Range mode

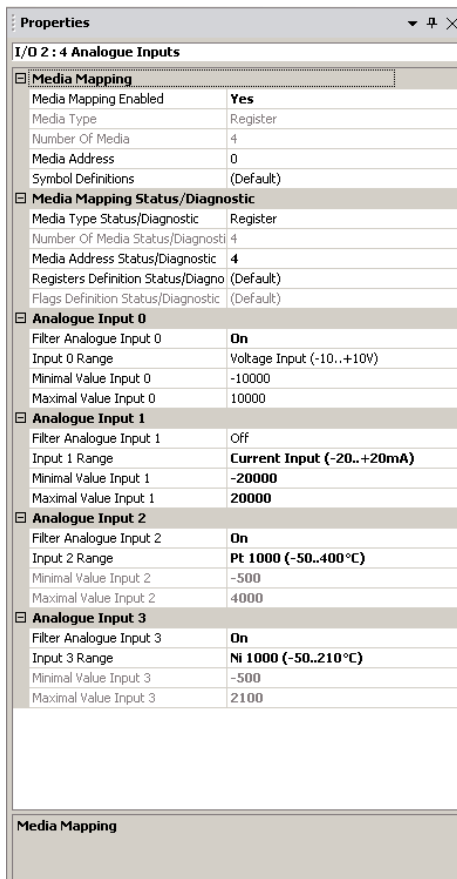

Filtering: The analogue inputs can be read directly (unfiltered) or a 16 tap floating average filter can be switched “ON” to reduce noise.

Possible Range mode:

- 12 Bit Resolution (default)
→ -4096..4095
- -20..+20mA in uA resolution
→ -20'000..20'000
- -10..+10V in mV or % resolution
→ -10'000..10'000
- User defined range
(Value between -32'768 and 32'767)
- Temperature measurement ranges:
 - Pt 1000: -50°C ... +400°C, Resolution 0.2°C
→ -500 ... +4000
 - Ni 1000: -50°C ... +210°C, Resolution 0.12°C
→ -500 ... +2100
 - Ni 1000 L&S: -30°C ... +140°C, Resolution 0.15°C
→ -300 ... +1400
 - Resistance: 0 ... 2500 Ω, Resolution 0.7Ω
→ 0 ... 25000



Don't forget to select the input range on the I/O Module.

c) Status information

The status information of the analogue input channels can be mapped to registers or flags. For each channel one Byte of status information is copied in the selected media. That means, in case of register use the status information is copied into the low Byte of the register, in case of flag use the status will be copied into an array of eight flags. The value of the status is actualized at each COB start.

In the status byte following information is available:

Bit 0: Overrange indicator

Bit 1: Underrange indicator

Bit 2...7: reserved **Definition of range, over/under range and status flag:**

Temperature inputs:

Type	min./max. staus flag	range values
Pt 1000 (-50...400 °C)	-500 / 4000	limites -500...4000
Ni 1000 (-50...210 °C)	-500 / 2100	limites -500...2100
Ni 1000 L&S (-30...140 °C)	-500 / 1400	limites -300...1400

Every time the min/max values are reached the min/max status flag will be set.

Resistance, voltage and current inputs:

The total range of values is defined by the type of range:

Type	min./max. staus flag	range of calculated values
Resistance 0...2500 Ω	0...25000	underrange not available over range 25500 (102%)
Voltage Input (-10...+10 V)	XX / YY	underrange at 2% of range overrange at 102% of range
Current Input (-20...+20 mA)	XX / YY	underrange at 2% of range overrange at 102% of range

Every time the min/max values are reached the min./max. status flag will be set.

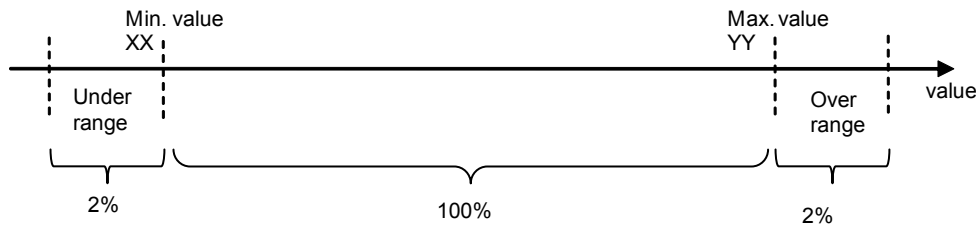

5.6 Analogue outputs properties

The analogue outputs of the PCD3 Compact can be mapped in registers. Select under “Onboard Inputs/Outputs” the line I/O 3, all corresponding properties appears on the right side.

- a) **Accessing over registers mapping**
 - 1) Enable Media Mapping
 - 2) Give first “Media Address” b

The 2 “output” registers values are transferred to analogue outputs at the end of COB:

Example: b=7

- AO0 = R7
- AO1 = R8

5

- b) **Possible Range mode:**
 - 12 Bit Resolution (default)
 - 0...4095
 - 0...10V in mV or % resolution
 - 0...10'000
 - User defined range
 - (Value between -32'768 and 32'767)



- c) **Reset Value Output:**
 - Defines the reset value of the output (Power -up initialization).

I/O 3 : 2 Analogue Outputs	
Media mapping	
Enabled Media Mapping	Yes
Media Type	Register
Number of Media	2
Media Address	7
Analogue Output 0	
Output 0 Range	0..10V in mV or % resolution
Minimal Value Output 0	0
Maximal Value Output 0	10000
Reset Value Output 0	0
Analogue Output 1	
Output 1 Range	12 Bit resolution
Minimal Value Output 1	0
Maximal Value Output 1	4095
Reset Value Output 1	0
Enabled Media Mapping	
Select 'Yes' to enable the media mapping for the analogue outputs; a cyclic actualization of the output values present in the memory image with the specified media content.	

5.7 General remarks



Overlappings are warned in the Messages window:

Messages			
!	Code	Item	Message
×	ER_1204	I/O 0 : 20 Digital Inputs	Register address range of this slot overlap with other register address range.
×	ER_1205	I/O 1 : 12 Digital Outputs	Flag address range of this slot overlap with other flag address range.

Symbol management

Group/Symbol	Type	Address/...	Comment
5	GROUP		
CPU	GROUP		
IO	GROUP		
ANALOGUE_INPUT_0		4	Address of analogue input 0 in memory input range - used for direct access
ANALOGUE_INPUT_1		6	Address of analogue input 1 in memory input range - used for direct access
ANALOGUE_INPUT_2		8	Address of analogue input 2 in memory input range - used for direct access
ANALOGUE_INPUT_3		10	Address of analogue input 3 in memory input range - used for direct access
ANALOGUE_OUTPUT_0		2	Address of analogue output 0 in memory output range - used for direct access
ANALOGUE_OUTPUT_1		6	Address of analogue output 1 in memory output range - used for direct access
AnalogueInput0	R	3	Analogue inputs 0
AnalogueInput1	R	4	Analogue inputs 1
AnalogueInput2	R	5	Analogue inputs 2
AnalogueInput3	R	6	Analogue inputs 3
AnalogueOutput0	R	7	Analogue outputs 0
AnalogueOutput1	R	8	Analogue outputs 1
COUNTER_ENCODER_0		1044	Address of counter/encoder 0 in memory input range - used for direct access
COUNTER_ENCODER_1		1048	Address of counter/encoder 0 in memory input range - used for direct access
DIGITAL_INPUT_0TO7		0	Address of digital 0 to 7 inputs in memory input range - used for direct access
DIGITAL_INPUT_8TO15		1	Address of digital inputs 8 to 15 in memory input range - used for direct access
DIGITAL_INPUT_16TO19		2	Address of digital inputs 16 to 20 in memory input range - used for direct access
DIGITAL_OUTPUT_0TO7		0	Address of digital outputs 0 to 7 in memory output range - used for direct access
DIGITAL_OUTPUT_8TO11		1	Address of digital outputs 8 to 12 in memory output range - used for direct access
DigitalInput0	F	0	Digital input 0
DigitalInput1	F	1	Digital input 1
DigitalInput2	F	2	Digital input 2
DigitalInput3	F	3	Digital input 3
DigitalInput4	F	4	Digital input 4
DigitalInput5	F	5	Digital input 5
DigitalInput6	F	6	Digital input 6
DigitalInput7	F	7	Digital input 7
DigitalInput8	F	8	Digital input 8
DigitalInput9	F	9	Digital input 9
DigitalInput10	F	10	Digital input 10
DigitalInput11	F	11	Digital input 11
DigitalInput12	F	12	Digital input 12
DigitalInput13	F	13	Digital input 13
DigitalInput14	F	14	Digital input 14

5

During programming, you can always drag & drop Symbols from “IO Group” under “System Symbol” of the Symbol Editor.
 HMI Editor need “Global Symbol” in this case copy & paste Symbols from “System Symbol”.

5.8 Firmware update

The PCD3.M2x3xV6 supports Firmware updates as known from the PCD3 family.

Furthermore it is also possible to update the I/O module firmware by using the SaiaPCD[®] firmware downloader as known from PCD3 CPU firmware updates.

6 Maintenance

PCD3 components are maintenance-free, apart from some CPUs, where the battery needs to be changed occasionally.

PCD3 components do not contain any parts that can be swapped out by the user. If hardware problems arise, the components should be returned to Saia Burgess Controls.

6.1 Changing the battery

The resources (registers, flags, timers, counters etc), and possibly the user program and the text strings/DBs, are stored in RAM. To ensure that they are not lost and that the hardware clock (where present) continues to run when there is a power outage, the PCD3s are equipped with a buffer battery.

CPU type	Buffer	Buffer time
PCD3.M2xx0	Renata CR2032 lithium battery	1-3 years ¹⁾

1) Depending on the ambient temperature; the higher the temperature, the shorter the buffer time

6



With new controllers, the batteries are packaged with the units, and have to be inserted on commissioning. Observe the polarity of the batteries:

CPUs with lithium batteries are not maintenance-free. The battery voltage is monitored by the CPU. The BATT LED lights up and XOB 2 is called if

- the battery voltage is less than 2.4 V
- the battery is missing



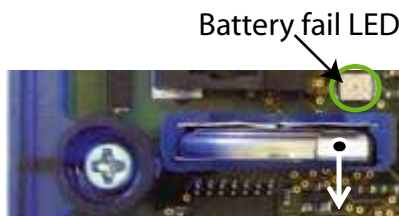

We recommend changing the batteries with the Saia PCD® attached to the power supply, to avoid any loss of data.



- Remove the controller cover
- Push the locking clip slightly towards the front (see arrow on the picture)
- Remove Battery
- Insert Renata CR 2032 coin cell in such a way that the positive pole is in contact with the locking clip, the light must switch off.

A Appendix

A.1 Icons

	<p>In manuals, this symbol refers the reader to further information in this manual or other manuals or technical information documents. As a rule there is no direct link to such documents.</p>
	<p>This symbol warns the reader of the risk to components from electrostatic discharges caused by touch. Recommendation: Before coming into contact with electrical components, you should at least touch the Minus of the system (cabinet of PGU connector). It is better to use a grounding wrist strap with its cable permanently attached to the Minus of the system.</p>
	<p>This sign accompanies instructions that must always be followed.</p>
	<p>Explanations beside this sign are valid only for the Saia PCD® Classic series.</p>
	<p>Explanations beside this sign are valid only for the Saia PCD® xx7 series.</p>

A.2 Definitions of serial interfaces

A.2.1 RS-232

Designation of signal lines:

Data lines	TXD	Transmit data
	RXD	Receive data
Signal and message lines	RTS	Request to send
	CTS	Clear to send
	DTR	Data terminal ready
	DSR	Data set ready
	RI	Ring indicator
	DCD	Data carrier detect

Signals to RS-232

Signal type	Logical state	Required value	Nominal value
Data signal	0 (space)	+3 V to +15 V	+7 V
	1 (mark)	-15 V to -3 V	-7 V
Control/ message signal	0 (off)	-15 V to -3 V	-7 V
	1 (on)	+3 V to +15 V	+7 V

The idle state of the data signals = "mark"
of the control and message signals = "off"

A.2.2 RS-485/422

Signals to RS-485 (RS-422)

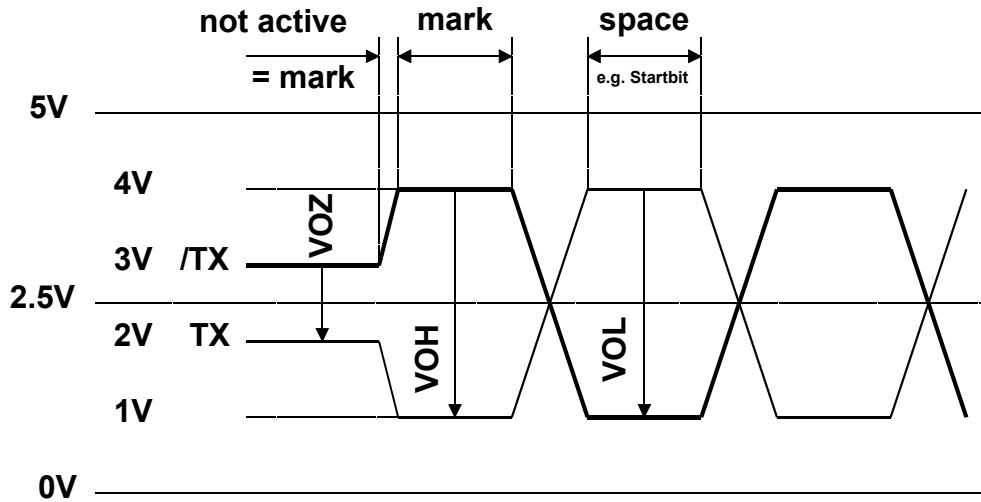

- VOZ = 0.9 V min ... 1.7 V
- VOH = 2 V min (with load) ... 5 V max (without load)
- VOL = -2 V ... -5 V

In the idle state, RS-422 is in the “mark” position

RS-422:

Signal type	Logical state	Polarity
Data signal	0 (space) 1 (mark)	TX positive to /TX /TX positive to TX
Control/ message signal	0 (off) 1 (on)	/RTS positive to RTS RTS positive to /RTS



RS-485:

Signal type	Logical state	Polarity
Data signal	0 (space) 1 (mark)	RX-TX positive to /RX-/TX /RX-TX positive to RX-/TX



Not all manufacturers use the same connection configuration, so the data lines may need to be crossed



To guarantee error-free operation of an RS-485 network, the network should be terminated at both ends. Cable and line termination resistors should be selected in accordance with manual 26/740 “Installation components for RS-485 networks”.

A.3 Order details

Type	Description	Weight
Basic units		
PCD3.M2130V6	CPU with 512 Kbytes user program, backup and onboard Flash memory, USB port for Saia PG5®, 2 Interrupts, Web-Server, RS-485, 32 digital I/O and 6 analogues I/Os, 1 port (socket A) for PCD7.F1xx, Ethernet TCP/IP, data protection 1-3 years, terminal blocks delivered	750g
PCD3.M2030V6	same as PCD3.M2130V6 without Ethernet TCP/IP	750g
Spares		
4 507 4817 0	Lithium battery Renata CR 2032	3 g
Communication modules on Socket A		
PCD3.F110	with RS-422/RS-485 interface (electrically connected)	80 g
PCD3.F121	with RS-232 interface (suitable for modem)	80 g
PCD7.F150	with RS-485 interface (electrical isolated)	80 g
PCD3.F180	Belimo MP-Bus (based on RS-232)	80 g
Module holder for expansions		
PCD3.C110	Module holder for 2 I/O modules (PCD3.K106/K116)	180 g
PCD3.C110Z09	Module holder for 2 I/O modules (PCD3.K010)	180 g
PCD3.C200	Module holder for 4 I/O modules (PCD3.K106/K116), with 24V supply	350 g
PCD3.C200Z09	Module holder for 4 I/O modules (PCD3.K010), with 24V supply	350 g
Accessories		
4 405 5066 0	Optional: Pluggable "Push-in" terminal block with LED, 10-pole, as connector for X1, X2, X3 & X4	12 g
4 405 5079 0	Optional: Pluggable "Push-in" terminal block with LED, 3×10 pole (3-wire connection) as connector for X1, X2, X3 & X4	30 g
PCD3.K106	Connecting cable 0.7 m	70 g
PCD3.K116	Connecting cable 1.2 m	90 g
PCD3.K010	Connector between CPU and expansion housing	90 g

A.4 Contact**Saia-Burgess Controls AG**

Bahnhofstrasse 18
3280 Murten
Switzerland

Phone +41 26 580 30 00

Fax..... +41 26 580 34 99

Email support: support@saia-pcd.com

Supportsite: www.sbc-support.com

SBC site: www.saia-pcd.com

International Representatives &

SBC Sales Companies: www.saia-pcd.com/contact

Postal address for returns from customers of the Swiss Sales office**Saia-Burgess Controls AG**

Service Après-Vente
Bahnhofstrasse 18
3280 Murten
Switzerland

A